



Eclipse Purge-and-Trap Sample Concentrator Operator's Manual



Notice

The information contained in this document may be revised without notice.

OI Analytical shall not be liable for errors contained herein or for incidental or consequential damages in connection with the furnishing, performance, or use of this material.

No part of this document may be reproduced, photocopied, or translated to another language without the prior written consent of OI Analytical.

Rev. 6.1 — February 2014

Agilent is a registered trademark of Agilent Technologies, Inc.

Carboxen is a registered trademark and VOCARB is a trademark of Supelco, Inc.

Cyclone Water Management, Foam Buster, Foam Sensor, Infra-Sparge, Low-Dead-Volume Injector, MicroTrap, Mud-Dawg, *pHDetect*, PT Express, Rapid Swap, and SOS are trademarks of OI Corporation.

Luer-Lok is a registered trademark of Becton-Dickenson Corporation.

Microsoft, Microsoft Access, MS-DOS, and Windows are registered trademarks of Microsoft Corporation.

Molex is a registered trademark of the Molex Corporation.

PEEK is a registered trademark of Victrex PLC.

PEM is a registered trademark of PennEngineering.

Parafilm is a registered trademark of American National Can Company.

Pentium is a registered trademark of Intel Corporation.

Silcosteel is a registered trademark of Restek Corporation.

Slo-Blo is a registered trademark of Littelfuse Corporation.

Swagelok is a registered trademark of Crawford Fittings Company.

Tenax is a registered trademark of Enka Research Institute Arnhem.

Teflon and Tefzel are registered trademarks of E.I. DuPont de Nemours, Inc.

Valco is a registered trademark of Valco Instrument Corporation.

VOCARB is a registered trademark of U.S. Filter Corporation.

OI Analytical Part Number 321604

Printed in the U.S.A.
Publication 19210214
Copyright 2014 OI Analytical

Limited Warranty

OI Analytical warrants each OI Analytical manufactured product against defects in materials and workmanship under normal use and service for a period of one year. Equipment installed by OI Analytical is warranted from the installation date; all other equipment is warranted from the ship date. If purchaser schedules or delays installation more than 90 days after delivery, then the warranty period starts on the 91st day from date of shipment. This warranty extends only to the original purchaser. OI Analytical will, at its option, repair or replace equipment that proves to be defective during the warranty period, provided the equipment is returned to OI Analytical at the expense of the purchaser.

Consumables, expendables, and parts are warranted for 30 days and are not covered under extended warranties or service contracts.

OI Analytical warrants for a period of one year from the date of delivery: (i) the Software, when installed and used with an OI Analytical recommended hardware configuration, will perform in substantial conformance with the documentation supplied with the Software; and (ii) the physical media on which the Software is furnished will be free from defects in materials and workmanship under normal use.

This warranty shall not apply to defects originating from, but not limited to, the following:

- Improper maintenance or operation by the purchaser;
- Purchaser-supplied accessories or consumables;
- Modification or misuse by the purchaser;
- Operation outside the product's environmental and electrical specifications;
- Software, interfacing, parts, or supplies not supplied by OI Analytical;
- A computer not meeting the minimum specifications recommended by OI Analytical;
- Improper or inadequate site preparation;
- Purchaser-induced contamination or leaks.

THE FOREGOING WARRANTY IS IN LIEU OF ALL OTHER WARRANTIES, EXPRESSED OR IMPLIED, INCLUDING BUT NOT LIMITED TO ANY WARRANTY OF MERCHANTABILITY, FITNESS, OR ADEQUACY FOR ANY PARTICULAR PURPOSE OR USE. OI ANALYTICAL SHALL NOT BE LIABLE FOR ANY SPECIAL, INCIDENTAL, OR CONSEQUENTIAL DAMAGES, WHETHER IN CONTRACT, TORT, OR OTHERWISE.

Any service requests or questions should be directed to the OI Analytical Customer Support Center at (800) 336-1911 or (979) 690-1711.



Table of Contents

Notice	ii
Limited Warranty	iii
Chapter 1: Introduction.....	1
Operating Principles	1
Features	1
Specifications.....	2
General Specifications	2
<i>Dimensions</i>	
<i>Weight</i>	
<i>Valve</i>	
<i>Sample Pathway</i>	
<i>Standard Glassware</i>	
<i>Optional Glassware</i>	
Performance Specifications	3
<i>Electronic Control</i>	
<i>Trap</i>	
<i>Programmable Temperature Ranges</i>	
<i>Water Management</i>	
<i>Infra-Sparge™ Sample Heater Option</i>	
Communications	4
<i>Output Signals</i>	
<i>Input Signals</i>	
<i>Communication Interface</i>	
Requirements	4
<i>Gas Requirements</i>	
<i>Power Requirements</i>	
<i>Fuse Requirements</i>	
<i>Computer Requirements</i>	
Patent Information	6
Major Options	6
Safety Information.....	6
Operator Precautions.....	7
General Precautions	7
Compressed Gas Cylinder Precautions	7
Safety Symbols	8
Chapter 2: Instrument Components	9
Eclipse Front Exterior Components	9
Eclipse Back Panel.....	11
Pneumatics Module Components.....	13
Electronics Module Interior Components.....	18
Chapter 3: Installation.....	19
Required Materials.....	19

Unpacking and Positioning the Eclipse	19
Installing External Cables	20
Remote I/O Communication Cabling	20
Using the Trace 2000/Ultra GC with the Eclipse	21
<i>Connect the Trace 2000/Ultra GC</i>	
<i>Configure the Trace 2000 GC</i>	
Installing Electrical Connections	23
Starting the Eclipse.....	24
Setting Up a New User ID	24
Installing the Optional PC Software.....	28
Installing Plumbing Connections	35
Installing the Sparge Vessel (Sparger).....	35
Installing the Needle Sparger Option.....	35
<i>Installing the Needle Sparger on the Four-Way Injection Valve</i>	
<i>Installing the Needle Sparger on the Three-Way Injection Valve</i>	
Installing Gas Connections	37
Connecting the Eclipse Transfer Line to the GC	38
Connecting the Eclipse Transfer Line to the Split/Splitless Injector.....	38
Connecting the Transfer Line Directly to the Column	39
Connecting the Transfer Line to the Low-Dead-Volume Injector™.....	39
Connecting the Autosampler to the Eclipse	39
Setting the Purge Gas Pressure and Flow Rate	40
Performing a Leak Test.....	42
Changing and Conditioning the Trap.....	43
Chapter 4: Eclipse User Interface	44
Main Menu Icons and Screens	44
Status Screen.....	45
Current Status Indicator	46
Cycle State Indicator.....	47
State Time, P&T Cycle Time, and Sequence Status.....	47
Purge Gas and Trap Backpressure Indicators	48
Command Icons	49
Graphic Display Icons.....	49
<i>Progress Bar Popup</i>	
<i>Temperature Graph Popup</i>	
Status Bar and Error Bar	51
Temperature Screen.....	52
Active Method Screen	53
Active Sequence Screen.....	56
Method Editor Screen	58
Sequence Editor Screen	61
General Configuration Screen.....	63
Configure Screen	64
<i>Basic Configure Screen</i>	
<i>Advanced Configure Screen</i>	
<i>Autosampler Configure Screen</i>	
<i>Options Configure Screen</i>	
Trap Configuration Screen.....	74
System Configuration Screen	76

Maintenance Screen	80
Chapter 5: Operation.....	83
Instrument States.....	83
State Sequencing.....	84
Cycle State Indicator.....	86
Operational Overview	86
Logging In	87
Using Configurations.....	87
Configuring the Eclipse	87
Working with Configurations	89
Using Sequences.....	89
Using the Sequence Editor.....	89
Working with Active Sequences.....	90
Inserting Priority Samples.....	92
Using Methods	93
Using the Method Editor.....	94
Using Active Methods	95
Loading and Running Samples	95
Manual Sample Loading	95
Syringe Sample Injection (Manual Injection).....	96
Needle Sparging.....	96
<i>Needle Sparging Liquid Samples</i>	
<i>Needle Sparging Solid or Sludge Samples</i>	
Autosampling	98
Trap Information.....	99
Trap Operating Conditions	100
Chapter 6: Maintenance	101
Maintenance Screen	101
Leak Tests	102
<i>Through Sparger Leak Test</i>	
<i>Bypass Sparger Leak Test</i>	
Manually Advance State	104
Rotate 6-Port Valve.....	105
pH Settings.....	105
Bakeout	106
Trap Condition	106
Purge/Bake	107
Counter Settings.....	107
Information	108
Fan Settings.....	109
Valve Settings	110
Heater Settings	111
4551 Sampler	111
Instrument Log.....	112
<i>Display a Log Entry</i>	
<i>Adding an Instrument Log Entry</i>	

<i>Adding an Operator Log Entry</i>	
<i>Importing Data</i>	
<i>Log Maintenance</i>	
Diagnostics.....	116
<i>Relay I/O Status Boxes A and B</i>	
<i>Status Mask Box</i>	
<i>Sensor Status Box</i>	
<i>Safety Switch Status Box</i>	
Reports	119
<i>Importing Reports</i>	
<i>View/Print Reports</i>	
<i>Exporting Reports</i>	
Hardware Maintenance	123
Exterior Maintenance.....	123
Maintaining the Trap.....	123
<i>Changing the Trap</i>	
<i>Conditioning the Trap</i>	
Maintaining the Sparger.....	125
Maintaining the Purge-Drain Needle	125
Interior Maintenance.....	126
<i>Maintaining the Sparge Filter Tube</i>	
Rinsing the Sample Pathway	127
<i>Symptoms Indicating the Need to Rinse the Sample Pathway with Methanol</i>	
<i>Required Equipment</i>	
<i>Rinsing the Eclipse Sample Pathway (not including the transfer line)</i>	
<i>Rinsing the Eclipse Transfer Line</i>	
Chapter 7: pHDetect™ Module.....	134
Introduction	134
Operating Principles.....	134
Features	135
Specifications.....	135
<i>General Specifications</i>	
<i>Performance Specifications</i>	
<i>Buffer Requirements</i>	
<i>Communications</i>	
Safety Information	136
<i>General Precautions</i>	
<i>Safety Symbols</i>	
Instrument Components	137
pHDetect Front Components	137
pHDetect Back Panel	138
Unpacking and Positioning the pHDetect Module.....	138
Installation.....	139
Configuring the pHDetect.....	141
<i>Enabling the pHDetect in the Eclipse software</i>	
<i>Enabling pH Measurement in the Method(s)</i>	
Configuring the Model 4552 Autosampler	144
Operation.....	144
pHDetect Module Operation.....	144
pH Settings.....	145

Calibrating the pHDetect Module	145
<i>Calibration Operation</i>	
<i>Automatically Calibrate during PURGE</i>	
<i>Prevent Automatic Calibration during PURGE</i>	
Maintenance	147
Exterior Maintenance	147
Storing the pH Probe	147
Cleaning the pH Probe	148
Cleaning the Glass Reservoir	148
Collection and Reporting of pH Data	149
Importing pH Reports	149
View/Print pH Reports	150
Exporting Reports	152
Replacement Parts	154
Assembly Diagrams	156
Flow Diagrams	158
Chapter 8: Foam Buster™ Option Installation	164
Installing the Foam Buster Option	164
Removing the Standard Sparge Mount	164
Installing the Foam Buster Sparge Mount	166
Installing the Foam Buster Heater/Thermocouple Assembly	167
Installing the Sample Needle	168
Installing the Foam Buster Option	169
Completing the Foam Buster Option Installation	169
Replacement Parts	172
Chapter 9: Foam Sensor™ Option	173
Installing the Foam Sensor™ Option	173
Chapter 10: Sparge Overfill Sensor (SOS™) Option	177
Installing the SOS	177
Assembling the SOS	177
Plugging in the SOS	177
Adjusting the SOS	178
Installing the SOS Assembly	180
Replacement Parts	182
Assembly Diagram	183
Chapter 11: On-Trap Injector Option	184
Installing the On-Trap Injector Option	184
Operating the On-Trap Injector Option	185
Assembly Diagram	186
Chapter 12: Troubleshooting	187
Eclipse Diagnostic Tools	187
Maintenance Screen	187

Purge Flow Controller and Purge Gas Pressure.....	187
Using the PING Diagnostic	188
Eclipse Error Messages.....	189
System Performance Troubleshooting	191
Contaminant Peaks.....	191
No or Low Response from P&T Analysis	195
Poor Recovery of Low or High Boiling Point Compounds.....	199
Chapter 13: Recommended Settings and Configurations....	201
Chapter 14: Connecting the Eclipse to a Network	206
Setup of a Single Instrument: Isolated Network	206
Assigning IP Addresses	206
Configuring TCP/IP on the PC	207
<i>Access the TCP/IP Properties Dialog Box</i>	
<i>Assign the IP Address and Subnet Mask</i>	
Configuring the Eclipse Connection.....	209
Modifying Eclipse Network Settings.....	210
Setup of Multiple Instruments: Isolated Network.....	211
Assigning IP Addresses	211
Configuring TCP/IP on the PC	212
<i>Access the TCP/IP Properties Dialog Box</i>	
<i>Assign the IP Address and Subnet Mask</i>	
Configuring the Eclipse Connection.....	213
Modifying Eclipse Network Settings.....	215
Setup of Multiple Instruments: Site LAN Using Static IP Addresses	216
Assigning IP Addresses	216
Configuring TCP/IP on the PC	216
Configuring the Eclipse Connection.....	216
Modifying Eclipse Network Settings.....	218
Setup of Multiple Instruments: Site LAN Using Dynamic IP Addresses.....	219
Configuring TCP/IP on the PC	219
<i>Access the TCP/IP Properties Dialog Box</i>	
<i>DNS Settings</i>	
Configuring the Eclipse Connection.....	221
Modifying Eclipse Network Settings.....	222
Setup of an Eclipse PC Unit.....	223
Chapter 15: Creating A New Eclipse Database	224
Chapter 16: Replacement Parts	230
Eclipse Sample Concentrator Parts	230
Foam Buster Option Replacement Parts	237
Infra-Sparge™ Option Replacement Parts.....	238
pHDetect™ Module Replacement Parts	238
Sparge Overfill Sensor (SOS™) Option Replacement Parts	239
Glassware Selection Guide.....	240
Part Number Lookup Table	241

Chapter 17: Assembly Diagrams	250
List of Assembly Diagrams	250
Assembly Diagrams	251
Chapter 18: Flow Diagrams	263
List of Flow Diagrams	263
Flow Diagrams	264
Index	284



Chapter 1 Introduction

The Eclipse 4660 Purge-and-Trap Sample Concentrator collects and transfers volatile organic compounds (VOCs) to a gas chromatograph (GC) or GC/mass spectrometer (MS) for analysis. It purges volatiles from water, soil, solids, and air (in tubes) for concentration onto a sorbent trap in compliance with USEPA, ISO, and other regulatory protocols. The sample transfer line connects to either a GC injection port, OI Analytical Low-Dead-Volume Injector™, or directly to the GC column using a low-volume union.

Operating Principles

The Eclipse purges (sparges) VOCs from liquid, solid, or gaseous (from a solid support) samples using a regulated flow of inert gas for a fixed time period. Analytes stripped from the sample (or transferred from an upstream autosampler) concentrate onto a cooled sorbent trap specific for the application. The trap heats rapidly and a valve switches, desorbing the analytes as a “plug” onto the GC column using a reversed carrier gas flow. The Cyclone Water Management™ system keeps most of the water transferred from the sample matrix to the trap during sparging in the concentrator. Lastly, the residual compounds and trapped water bake out and vent, reducing interference with subsequent reconcentration, separation, or detection of analytes.

Features

- Microsoft® Windows® CE touchscreen provides an easy-to-navigate, intuitive user interface.
- *pHDetect* module fully automates sample pH measurement.
- Foam Buster™ and Foam Sensor™ options prevent system contamination.
- Sparge Overfill Sensor (SOS™) averts system flooding.
- Electronic pressure sensing with automated leak checks monitors the system for flow problems.
- Electronic log tracks changes, events, faults, and errors.
- Rapid Swap™ modular design and integrated diagnostics simplify instrument maintenance.
- Low-volume pneumatics ensure superb chromatography.
- Optional Infra-Sparge™ Sample Heater provides rapid sample heating with temperature feedback from within the sample.
- Built-in Cyclone Water Management™ minimizes water transfer to the analytical column and detector.

- 5- and 25-mL frit and needle spargers use the same length needle and wide-neck 18-mm mount.
- Controlled temperature of each heated zone maximizes reproducibility.
- Rapid trap heating (>1,000 °C/minute) and cooling (250 °C/minute) optimize chromatography and reduce run times.
- Inert, gas-impermeable, Silcosteel®-treated sample lines prevent contamination.
- Power-up self tests and diagnostic messages facilitate troubleshooting.

Specifications

General Specifications

Dimensions

- 43.7 cm H x 25.9 cm W x 40.6 cm D
- 17.2" H x 10.2" W x 16" D

Weight

- 14.5 kg (32 lbs)

Valve

- Electrically DC actuated
- Six-port, 60° rotation
- Removable rotor

Sample Pathway

- Silcosteel Q/qy" tubing
- Silcosteel transfer line: 48" standard; 60" optional

Standard Glassware

- 5-mL frit sparger (18-mm neck)

Optional Glassware

- 5-mL needle sparger (18-mm neck)
- 25-mL needle sparger (18-mm neck)
- 25-mL frit sparger (18-mm neck)

Performance Specifications**Electronic Control**

- Full color, Windows CE-based touchscreen graphical user interface
- 500 programmable methods with naming capability
- Flexible method and sample sequencing

Trap

- 0.125" O.D. x 0.105" I.D.
- Direct resistive heating
- Manual flow control with electronic pressure monitoring
- >1,000 °C/minute heating rate to 300 °C
- Maximum setpoint: 450 °C
- >240 °C/minute cooling rate (200–30 °C in <50 seconds)
- Minimum cooldown: to ambient temperature +1 °C

Programmable Temperature Ranges

- Trap: ambient to 450 °C during desorb and bake
- Sample transfer line: ambient to 295 °C
- Valve oven: ambient to 350 °C
- Sparge mount: ambient to 200 °C
- Infra-Sparge™ Sample Heater option: ambient to 200 °C
- Air-Tube Desorber option: 350 °C for air tubes
- Water management: 1 °C above ambient to 240 °C
- Heated zones tested during system self-test
- Temperature accuracy: $\pm 2\%$ or 2 °C (whichever is greater) for *all* heated zones
- Temperature stability: $\pm 2\%$ or 2 °C (whichever is greater) for *all* heated zones

Water Management

- Eliminates all but approximately 0.25 μL (0.063 $\mu\text{L}/\text{minute}$) of trapped desorbed water
- Maximum temperature: 240 °C
- Cooldown temperature: ambient +1 °C
- Water removal at level equivalent to condensation at 4.8 °C
- Excellent performance with polar compounds

Infra-Sparge™ Sample Heater Option

- Infrared lamp heating method
- Internal-to-sample temperature measurement (feedback)
- Maximum sample heating rate: >30 °C/minute (5 mL); >17 °C/minute (25 mL)
- Temperature range: ambient to 200 °C
- Sparge mount temperature: ambient to 200 °C

Communications *Output Signals*

- Two-second contact closure at purge start or purge end, start desorb, and start bake
- Contact closure during purge ready

Input Signals

- Two second minimum contact closure required from the external device at purge ready to purge and desorb ready to desorb

Communication Interface

- LAN connection
- Full color, Windows CE-based touchscreen graphical user interface
- Windows-based PC operation software package
- RS-232 to Model 4551A Autosampler
- RS-485 to autosamplers
- RS-232 to external devices
- I²C to pH*Detect* module

Requirements *Gas Requirements*

- 99.999% helium or nitrogen purge gas

Power Requirements

- 115 V_{AC}; 50/60 Hz
- 230 V_{AC}; 50/60 Hz
- 750 VA maximum

WARNING: Eclipse pneumatic and electronic modules are labeled as 115 or 230 Volt modules. Never mismatch modules designated for different voltages. A mismatch will result in equipment damage.

Fuse Requirements

- 6.3 A; 250 V Slo-Blo®

Environmental Requirements

- Indoor use only
- Operating temperature 5 - 40 °C
- Maximum altitude 2000 meters
- Maximum relative humidity 80% up to 31 °C; 50% 32 - 40 °C

Computer Requirements

Parameter	Minimum	Recommended
Computer	IBM compatible	IBM compatible
Processor/speed	Pentium® III/450 MHz	Pentium IV/2.0 GHz
Memory (RAM)	>256 MB (256 MB free)	512 MB
Free hard drive space	120 MB	200 MB
Operating system	Windows® NT 4 SP6 operating system or later	Windows® NT, Windows® 2000, Windows® XP Pro, Windows Vista™ ¹ operating system or later
Graphics	XGA adapter card with 512K RAM onboard (min. 1024 x 768 x 256 colors)	XGA adapter card with 1 MB RAM onboard (1280 x 1024 x 16-bit color)
Monitor	Color XVGA	Color XGA
Disk drive	CD-ROM	CD-ROM
Network adapter ²	10-base-T	10-base-T or 10/100-base-T

¹ Refer to the Windows Vista Documentation tab on the installation CD for more information.

² If the computer does not support 10-base-T (e.g., 100/1000-base-T or 100-base-T), use a 10/100 switching hub.

Microsoft Access® 2000 or later is required to generate and view reports using the version 2.0 or earlier of the optional Eclipse PC software. Version 2.1 PC software does not require Microsoft Access®.

Patent Information The Eclipse 4660 and its components may be protected by one or more of the following patents:

Patent Number	Date Issued	Title
Pending		pH Measurement System
U.S. 6,894,784	May 17, 2005	Foam Detector and Disruptor
U.S. 5,814,128	September 29, 1998	Water Management Device for GC Sample Concentration
U.S. 5,582,633	December 10, 1996	Water Management Device for GC Sample Concentration
U.S. 5,358,557	October 25, 1994	Water Management Device for GC Sample Concentration
U.S. 5,337,619	August 16, 1994	Radiant Energy Sample Heating and Temperature Control
U.S. 5,261,937	November 16, 1993	Sample Concentration Filter
U.S. 5,250,093	October 5, 1993	Water Management Device for GC Sample Concentration

Major Options

- pHDetect™ option
- Foam Buster™ option
- Foam Sensor™ option
- Sparge Overfill Sensor (SOS™) option
- Infra-Sparge™ Sample Heater
- Purge-and-trap injector for GC-LDVI
- On-Trap Injection Port
- Air-Tube Desorber Accessory

Safety Information

The Eclipse 4660 Sample Concentrator meets the European Council directives for emissions and safety as noted in the Declaration of Conformity for this instrument as tested and documented by a certified independent laboratory.



Operator Precautions

For operator safety, pay attention to **WARNING** and **CAUTION** statements throughout the manual.

- A **WARNING** indicates a condition or possible situation that could result in physical injury to the operator.
- A **CAUTION** indicates a condition or possible situation that could damage or destroy the product or the operator's work.

Follow warnings and precautions in this manual or on the instrument during operation, service, and repair. Failure to follow these warnings and precautions violates the safety design standards and intended use of the instrument. OI Analytical is not be liable for the operator's failure to comply with these warnings and precautions.

Connect the Eclipse to a dedicated AC power supply through a three-conductor power cord with the third wire firmly connected to an electrical ground at the power outlet. **Any interruption of the grounding conductor or disconnection of the protective earth terminal could cause a shock that could result in personal injury.**

General Precautions

- Disconnect the AC power cord before removing covers.
- Replace or repair faulty or frayed insulation on power cords.
- Perform periodic leak checks on supply lines, fittings, and pneumatic plumbing.
- Arrange gas lines so they can not become kinked, punctured, or otherwise damaged, and will not interfere with walkways.
- Turn off the main power switch and disconnect the main power cord before using a liquid solution to locate leaks.
- Wear safety glasses to prevent possible eye injury.
- Do not perform unauthorized modifications or substitute parts that are not OI Analytical original parts to the instrument. Any unauthorized modifications or substitutions voids the warranty.
- Do not position the unit so that access to the power cord is impeded.

Compressed Gas Cylinder Precautions

- Store and handle compressed gases in strict accord with relevant safety codes.
- Fasten all cylinders securely to an immovable structure or permanent wall.
- Store or move cylinders only in a vertical position. Do not move or transport cylinders with the regulators attached.
- Use only approved regulators and tubing connections.
- Connect cylinders to instruments with pressure ratings that are significantly greater than the highest outlet pressure from the regulator.
- Nitrogen and helium have been identified as asphyxiants. Handle and store these gases and the cylinders containing them in a manner consistent with OSHA

regulations. Maintain adequate ventilation in areas where these materials are used and stored. Avoid prolonged exposure to high concentrations of these gases.

Safety Symbols

The following symbols may be located on the instrument:



Warning/Caution, see accompanying instruction for more information.



Indicates a hot surface.



Indicates hazardous voltages.



Indicates earth (ground) terminal.

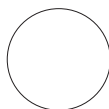

Indicates the OFF position on the power switch.



Indicates the ON position on the power switch.



Chapter 2 Instrument Components

Eclipse Front Exterior Components



Figure 2.1. Eclipse front exterior components

Electronics access cover (not shown) allows access to the Eclipse's electronics module without removing the instrument cover.

Four-way (or three-way) injection valve connects to the drain line when the Eclipse is configured for frit sparging, or the purge gas line if the instrument is configured for needle sparging. The fourth port on the four-way valve connects the sample transfer line from the Model 4551A or Model 4552 Autosampler, or can be plugged if no autosampler is used.

Front cover shields the sparge vessel and other components during operation and protects the operator from hot surfaces if using the Infra-Sparge™ Sample Heater option. The operator can visually monitor the sample through the clear cover. Remove the cover by pulling it forward. With the cover removed, a safety switch cuts power to the Infra-Sparge™ Sample Heater option.

Infra-Sparge™ Sample Heater option uses high-intensity infrared energy to heat water, soil, or solid samples. An inert thermocouple submerged in the sample provides direct sample temperature feedback.

Not Ready LED flashes to indicate the Eclipse's not ready condition.

Pneumatics access cover allows easy access to the Eclipse trap and most of the pneumatics without removing the instrument cover. With this door open, a safety shutoff switch cuts power to the trap.

Power LED indicates the power status and lights when the power switch is on.

Sample injection port connects to the four-way (or three-way) injection valve and is used to manually inject or drain a water sample into the sparge vessel using a syringe with a Luer-Lok® fitting. This valve also connects to the drain line when the Eclipse is configured for frit sparging, or the purge gas line if configured for needle sparging.

Side access panel allows access to the Eclipse pneumatics module's interior components.

Sparge mount cover provides insulation for the sparge mount. This cover slides forward to expose the sparge mount fittings.

Sparge mount side port connects the on-trap injector option or the heated transfer line from a Model 4552 Autosampler.

Touchscreen display provides a full color, Windows CE-based operator interface for entering and viewing all system settings and parameters.

Vent slots aid in cooling the Eclipse interior. Do not cover these slots during operation.

Eclipse Back Panel

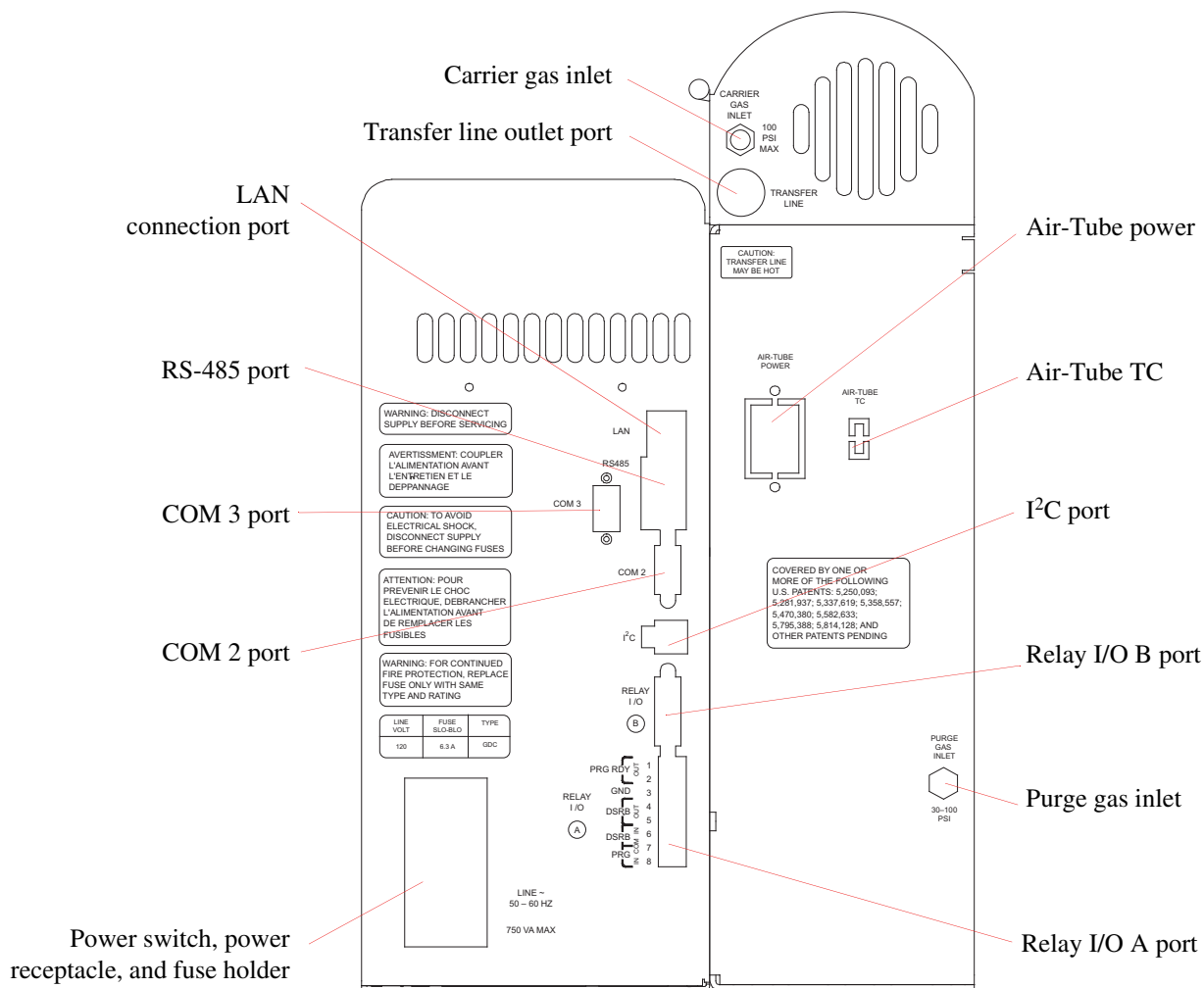

Figure 2.2. Eclipse back panel

Air-Tube power connects the Air-Tube Desorber option's power cord to the Eclipse.

Air-Tube TC connects the Air-Tube Desorber option's thermocouple to the Eclipse.

Carrier gas inlet uses a Q/qy" carrier gas supply line to connect the Eclipse to the GC's carrier gas control (usually from the injector pneumatics flow controller system, EPC or manual). Supply carrier gas at 100 psi maximum pressure.

COM 2 port (nine-pin RS-232 connector) connects the Eclipse to the Model 4551A Autosampler.

COM 3 port (nine-pin RS-232 connector) connects the Eclipse to external devices (for future use).

Fuse holder contains the main fuses that protect the Eclipse from a short circuit condition.

I²C port (four-pin connector) connects the Eclipse to the pH*Detect* module.

LAN connection port provides an Ethernet/LAN-based communication port that connects the Eclipse to either a PC or directly to a local area network connector.

Power receptacle connects the Eclipse to an appropriate power source via a power cable.

Power switch turns power on and off. Turning power on initiates a powerup selftest.

Purge gas inlet connects the Q/i" purge gas supply line from a secondary regulator set at 30 to 100 psi.

Relay I/O A port (eight-pin Phoenix connector) provides a hard-wired relay I/O communication interface from the Eclipse to any GC system. The port sends outgoing and accepts incoming relay contact closures. Use this port when no GC-specific interface cable is available or to connect the Eclipse to the Model 4552 Autosampler.

Relay I/O B ports provides a communication interface from the Eclipse to any GC system. The port sends outgoing and accepts incoming relay contact closures. The standard interface cable provided connects to another interface cable for a specific GC brand (ordered separately).

RS-485 ports are for future use.

Transfer line outlet ports allow the transfer line to exit the Eclipse and provide strain relief. Two ports are available: the standard port on the back of the unit, and an optional side port (not shown). Use the optional side port with a shorter transfer line, which shortens the sample pathway. The transfer line to the GC, a Q/qy" Silcosteel-treated, heated line, carries volatiles desorbed from the trap to the GC. The temperature setting is operator selectable.

Pneumatics Module Components

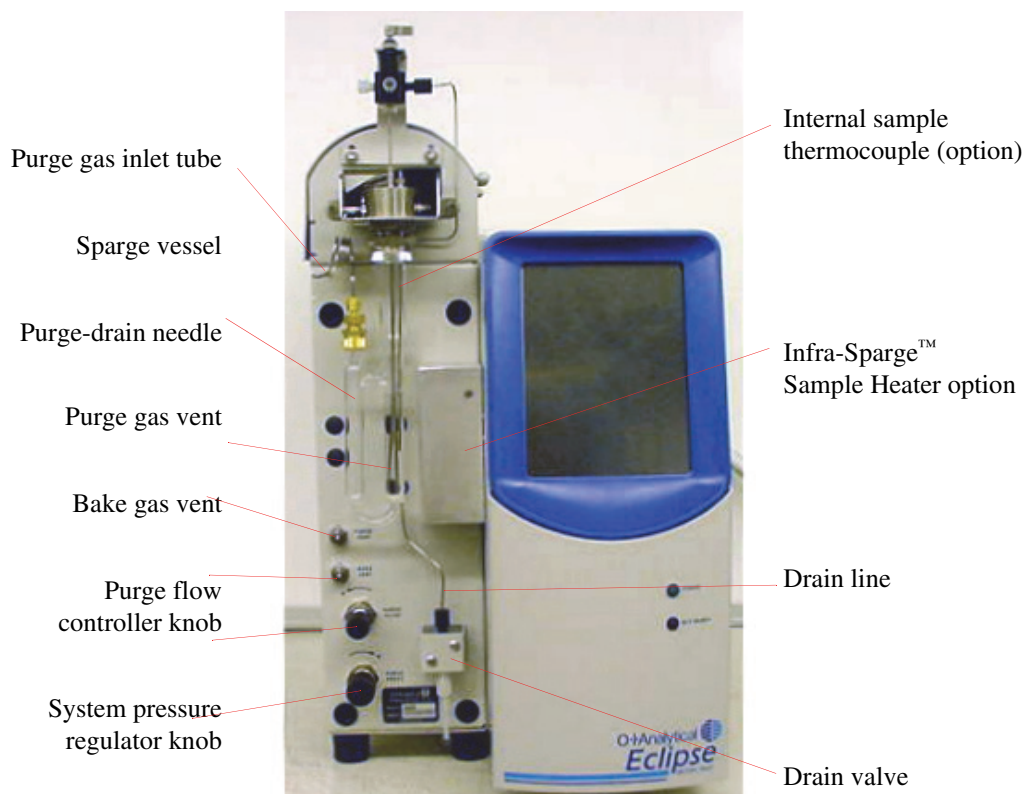

Figure 2.3. Pneumatics module exterior components

Bake gas vent connects a flow meter for gas flow measurement through the trap during bake.

Drain line is a stainless steel line that drains the sparger. It runs through an isolation drain valve on the Eclipse front exterior, which opens to drain the sample. All liquid routes outside of the instrument. A long length of Teflon® tubing connects to the drain valve's outlet port and routes underneath the Eclipse. Direct the drain line to a sink, waste receptacle, or connect it to the *pHDetect* module.

Drain valve is a two-way, normally closed isolation valve that controls the drain flow through the drain line.

Purge gas inlet tube connects the purge gas line from the dry purge valve inside the Eclipse to the purge inlet arm of a frit-style sparger. This tube supplies purge gas to the glassware when using a frit sparger.

Infra-Sparge™ Sample Heater option uses high-intensity infrared energy to heat water, soil, or solid samples. An inert thermocouple submerged in the sample provides direct sample temperature feedback.

Internal sample thermocouple provides direct sample temperature feedback to the Infra-Sparge™ Sample Heater option for temperature monitoring and control of heated samples.

Needle sparge line (not shown) connects the gas line from the dry purge valve to the four-way (or three-way) injection valve when needle sparging. This line supplies purge gas to a needle-style sparger through the sample purge needle.

Purge-drain needle provides the pathway for samples to enter the sparge vessel. It supplies purge gas directly into the sample when needle sparging and provides a drain pathway when frit sparging. If removed, the sparge mount must be appropriately plugged to close the system (e.g., when performing air-tube desorption with the Eclipse).

Purge flow controller knob adjusts the purge gas flow rate. The purge gas pressure regulator supplies pressure to the purge flow controller. Turn this knob counterclockwise to increase the purge gas amount passing through the sample each minute (usually set to 35–40 mL/minute).

Purge gas vent connects to a flow meter for purge gas flow measurement. Adjust the flow using the purge gas flow controller.

Sparge vessel is a reservoir for sample purging. Vessels are available in 5-mL, 10-mL, or 25-mL sizes, in either frit style (usually for clean water samples) or needle-sparge style (for particulated or soil/solid waste samples).

System pressure regulator knob adjusts incoming purge gas pressure supplied to the purge flow controller. Turn this knob clockwise to increase the purge gas pressure supplied to the purge flow controller. The recommended system pressure setting is 20–24 psi (see Chapter 3, “Setting the Purge Gas Pressure and Flow Rate” on page 40).

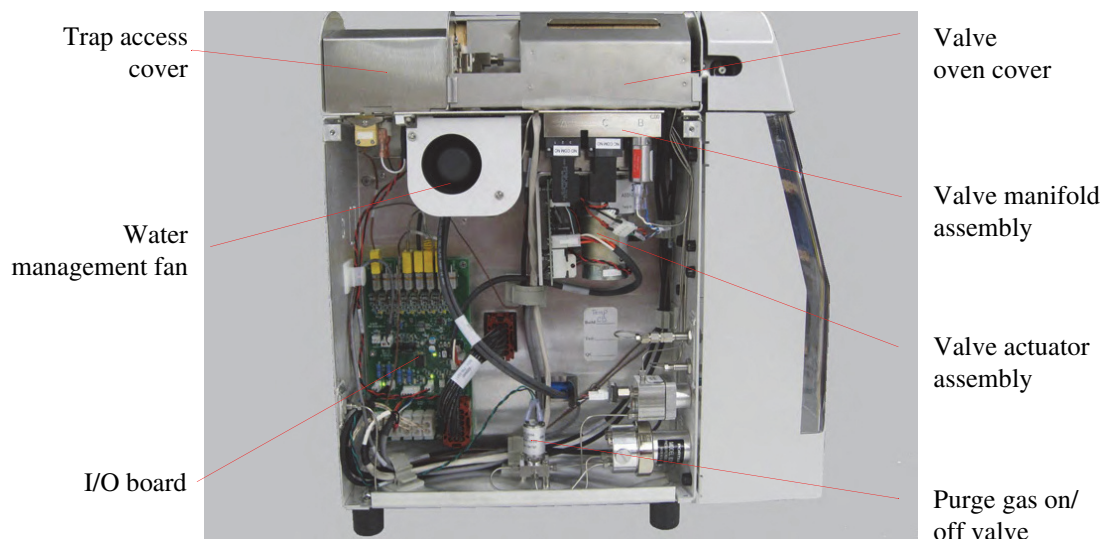

Figure 2.4. Pneumatic module interior components

I/O board interfaces to all of the Eclipse's heaters, thermocouples, and valves.

Purge gas on/off valve controls gas to the Eclipse.

Trap access cover shields the trap oven to ensure proper trap cooling. If the trap cooling rate is insufficient, a warning message displays.

Valve actuator assembly rotates the six-port valve.

Valve manifold assembly contains the dry purge valve, backflush bake valve, and bake vent valve.

Water management fan cools the water management fitting during desorb.

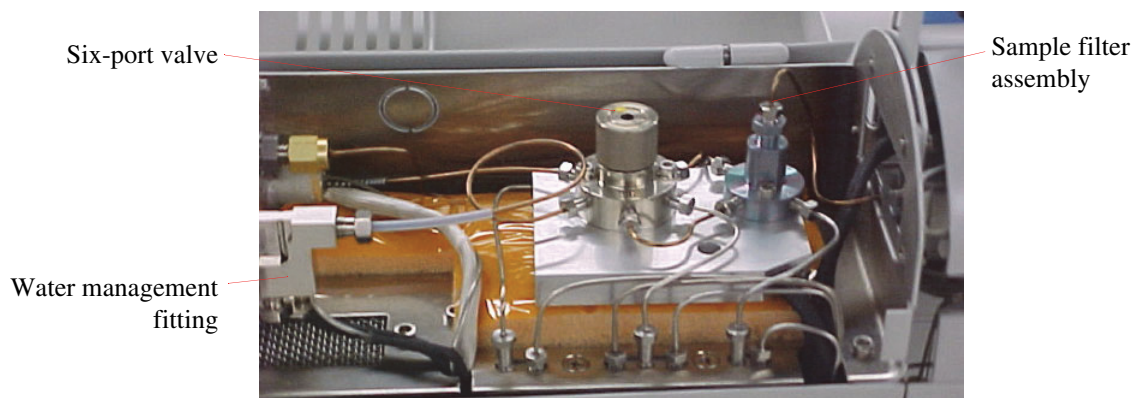

Figure 2.5. Pneumatics module interior components close-up view

Six-port valve controls flows through the Eclipse.

Sample filter assembly protects the Eclipse valve and interior components from particulates in foaming samples, which are often encountered in purge-and-trap analysis. An optional assembly without a filter can be used with selected applications that do not need the filter.

Water management fitting is an inert, plated fitting that reduces the amount of water transferred to the GC during analysis. It provides an inert connection for lines routed from the trap to the six-port valve.

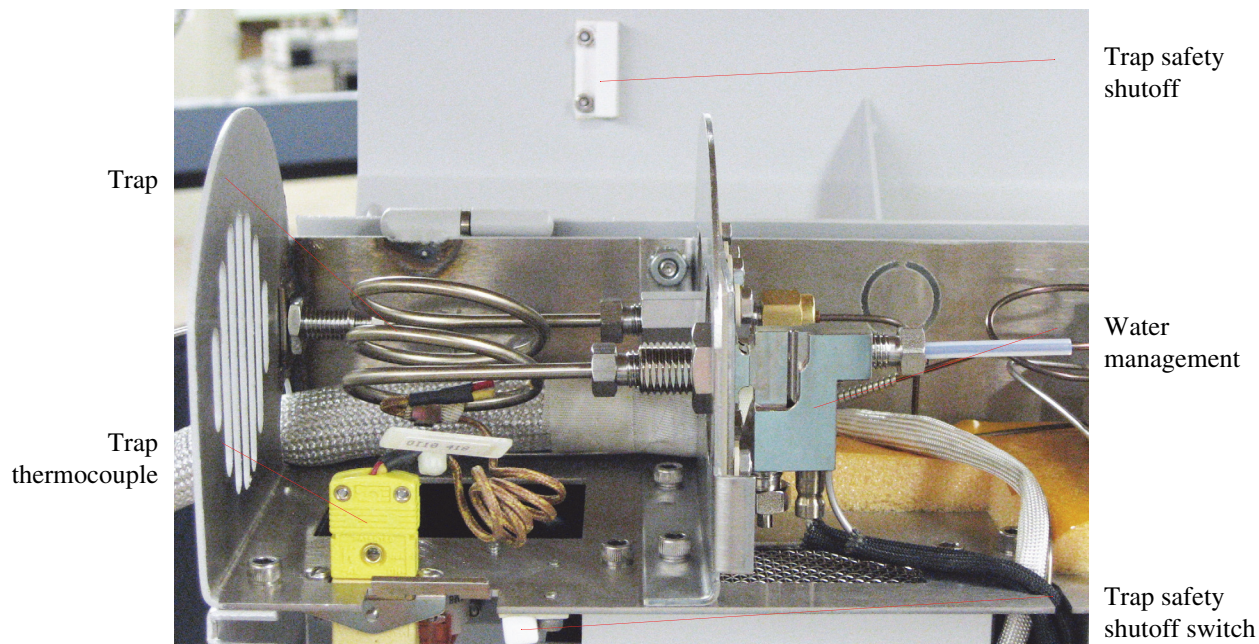

Figure 2.6. Trap oven interior components

Trap is an application-specific purge-and-trap system component that adsorbs volatile compounds purged from the sample. OI Analytical provides traps with varying lengths and solvent bed types to best suit a particular application. See Chapter 5, “Trap Information” on page 99 for more details.

Trap power lines (not shown) provide electrical current directly to the trap bulkhead fittings used to heat the trap through direct resistive heating.

Trap safety shutoff switch is a magnetic switch that interrupts power to the trap when the pneumatics access door is opened.

Trap thermocouple connector provides trap temperature feedback to the I/O board in the Eclipse.

Water management fitting is an inert, plated fitting that reduces the amount of water transferred to the GC during analysis. It provides an inert connection for lines routed from the trap to the six-port valve.

Electronics Module Interior Components

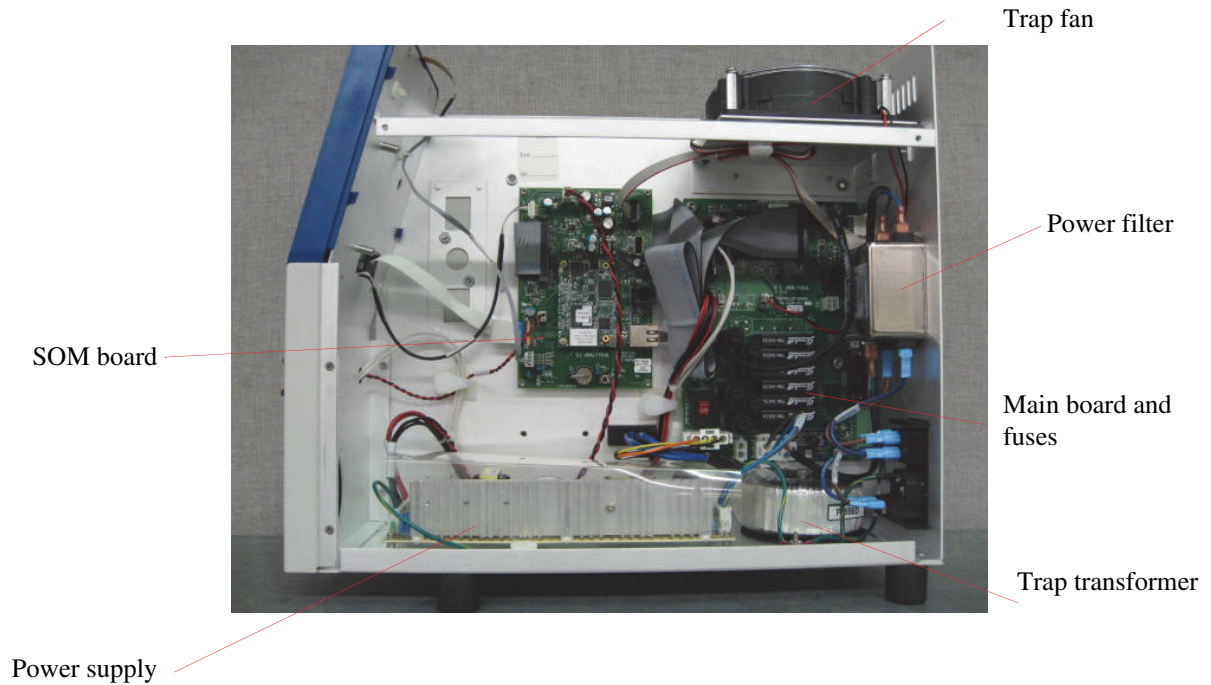

Figure 2.7. Electronics module interior components

Main board and fuses run all external connections and control heater functions.

Power filter filters the A/C power.

Power supply provides 12 V_{DC} power.

Trap fan cools the trap during purge.

Trap transformer provides power to the trap.

SOM board runs the Eclipse user interface and Windows CE functions.



Chapter 3 Installation

This chapter describes the Eclipse's basic installation procedure. Failure to complete all sections of this procedure may result in incomplete installation and improper Eclipse operation.

Required Materials

OI Analytical does not provide the following items required for installation with the Eclipse startup kit (PN 321603).

- **Purge gas source:** Connect a purge gas source (99.999% pure He or N₂), regulated to a pressure between 30 and 100 psi (207–1,724 kPa), to the purge gas inlet (50 psi is recommended). *OI Analytical highly recommends external gas scrubbing.*
- **Gas hookup lines:** Plumb solvent-rinsed, baked (or chromatographic grade) copper tubing to within five feet of the Eclipse. A clean stainless steel or copper Q/i" (3.2 mm) O.D. gas hookup line connects the purge gas source to the Eclipse purge gas inlet (five feet of precleaned copper tubing is provided).
- **Carrier gas source:** Provide a carrier gas source to the flow controller of the GC interfaced to the Eclipse. Follow the GC or GC detector manufacturer's recommendations for gas purity and pressure requirements. The Eclipse's carrier gas purity requirements are the same as the purge gas. The allowable pressure range is 0–100 psi (0–1,724 kPa).
- **GC interface kit:** Interface the Eclipse to the GC using components for connecting the GC carrier gas outlet to the Eclipse carrier gas inlet and for connecting the Eclipse transfer line to the GC injection port. An appropriate P&T pigtail interface cable specific for the GC is also required. The startup kit includes interface components for most GCs. Some GCs require additional hardware and kits.
- **Power source:** The Eclipse requires a standard receptacle for 110 VAC (+10/–15%) power capable of providing 8 A or 220 VAC (±10%) at 4 A. The 1.83-m (six-foot) power cord is provided.

Unpacking and Positioning the Eclipse

Unpack the instrument(s) and check the items against the packing list. Verify all kits are complete using the supplied component lists. If any components are missing, contact OI Analytical Customer Service at (800) 336-1911 or (979) 690-1711

NOTE: Some items on the component list may be already installed on the Eclipse or the autosampler.

If any damage appears, notify the carrier immediately. Save all packing materials until verifying proper operation of all components.

NOTE: Ship all instruments returned to OI Analytical for service or warranty repair with a return material authorization (RMA) number and in the original OI Analytical box with its packing materials. If instruments are damaged due to improper shipping, OI Analytical is not be responsible for the repair costs. Obtain the RMA number from the OI Analytical Customer Support Center at (800) 336-1911 or (979) 690-1711. If there is no access to proper shipping materials, contact OI Analytical Order Entry at (800) 336-1911 or (979) 690-1711.

1. Remove the Eclipse from the shipping carton.
2. Position the Eclipse on the side of the GC nearest the GC injection port. The Eclipse's installed, standard 48" sample transfer line may be exchanged for an optional 60" line if needing a longer transfer line to the GC. Alternatively, route the transfer line through the transfer line outlet port on the side of the pneumatics carrier for four to five inches of additional length.
3. Clear space under the instrument for proper air flow during operation. Do not block the side vent slots.
4. Place the drain line from the Eclipse into the sink or an appropriate waste receptacle, or connect it to the pHDetect module (see Chapter 7, "Specifications" on page 135).
5. Place the pHDetect unit next to the Eclipse.

CAUTION:

Placing the Eclipse on a hot surface inhibits proper trap cooling and affects results.

Installing External Cables

The following figures depict communication cabling for several standard instrument configurations. All figures show a back view. For a list of connection cables, see Chapter 16, "Replacement Parts" on page 230.

Remote I/O Communication Cabling

Install remote I/O cabling to enable the Eclipse to communicate to the GC or GC/MS (see Figure 3.1 for GC and Figure 3.2 for GC/MS).

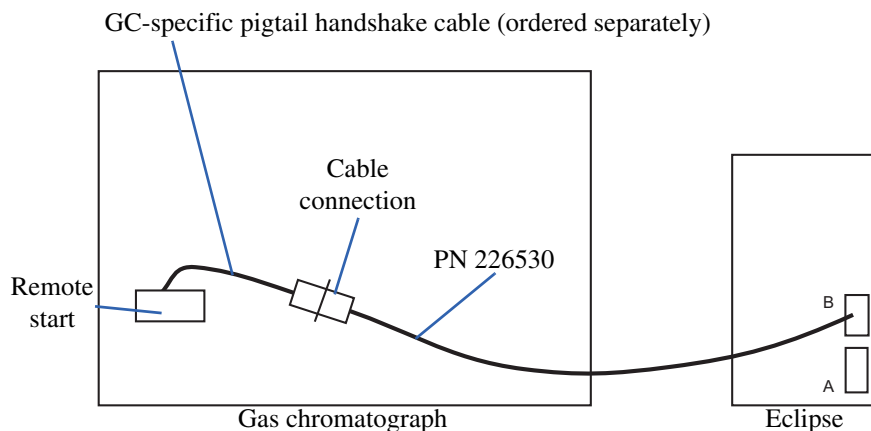

Figure 3.1. Communication cabling between a GC and Eclipse

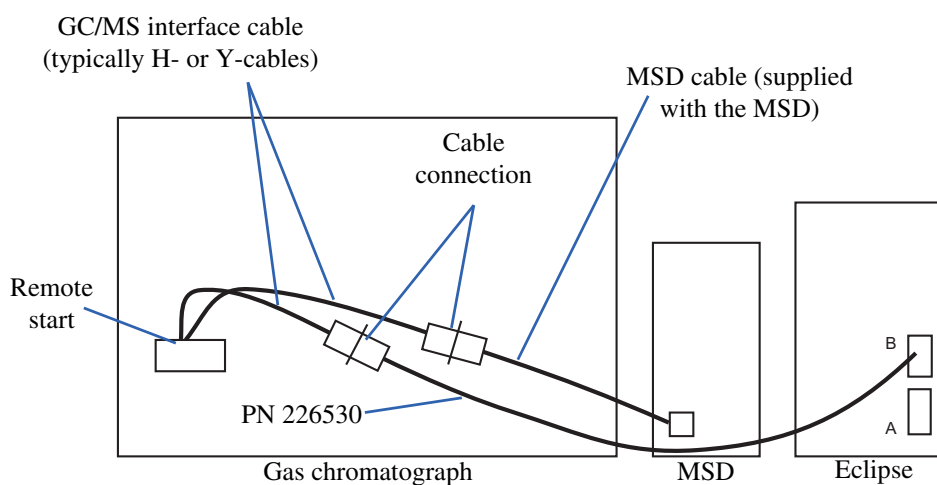

Figure 3.2. Communication cabling between the GC/MSD and Eclipse

Using the Trace 2000/Ultra GC with the Eclipse

Connect the Trace 2000/Ultra GC

Connect the Trace 2000 GC to the Eclipse using the following instructions:

1. Connect the six-pin connector of the handshake cable (PN 319822) to the six-pin MINI-DIN connector labeled "Autosampler" located on the Trace 2000 GC back (Figure 3.3, see Table 3.1 and Table 3.2 for pinouts).
2. Connect the four-pin connector of the handshake cable to the four-pin Molex[®] connector of the interface cable (PN 226530, included in the Eclipse startup kit).

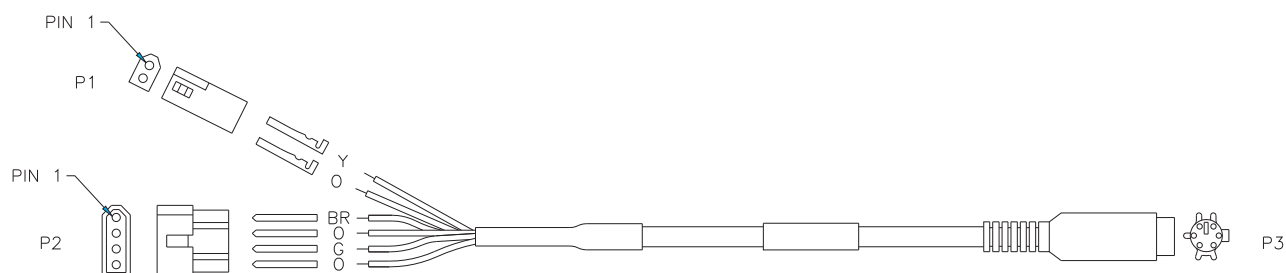

Figure 3.3. Handshake cable (PN 319822)

Table 3.1. Handshake cable (PN 319822) pinouts

P1	P2	P3	Color	Function
1	–	4	Yellow	Start run out (from Trace 2000)
2	2	3	Orange	Ground
–	1	1	Brown	Remote start in (to Trace 2000)
–	3	5	Green	GC ready out (from Trace 2000)
–	4	3	Orange	Ground
–	–	2	Red	Inhibit ready
–	–	6	Blue	End run (stop current run)
–	–	Shell	Bare	N/A

Table 3.2. Autosampler six-pin MINI-DIN connector pinouts

Pin Number	Color	Function
1	Brown	Remote start in
2	Red	Inhibit ready
3	Orange	Ground
4	Yellow	Start run
5	Green	Ready out
6	Blue	End run
Shell	N/A	N/A

Configure the Trace 2000 GC

Configure the Trace 2000 GC to accept signals from the Eclipse using the following steps:

1. Press [CONFIG] on the Trace 2000 GC front panel to access the Configuration screen.
2. Scroll to select “Handshaking.” Press [ENTER]. The Config Handshaking screen appears.
3. Scroll to select “Remote Start In.” Press [ENTER] to access the Remote Start screen.
4. Use [UP] and [DOWN] to select “High to Low.” Press [ENTER] to save the selection.
5. Press [CONFIG] again. Choose “Handshaking” and press [ENTER].
6. Scroll to select “GC Ready Out” and press [ENTER] to access the Ready Out screen.
7. Use [UP] and [DOWN] to select “When Low.” Press [ENTER] to save the selection.
8. Configure the Eclipse to interface with the GC:
 - a. Access the Advanced Configure screen. See Chapter 4, “Advanced Configure Screen” on page 66 for more information.
 - b. Select **Normal** for Expect Ready from GC.

Installing Electrical Connections

1. Verify the Eclipse’s voltage requirement (115 VAC \pm 10% or 230 VAC \pm 10%). Plug one end of the power cable (PN 116038) into the Eclipse power receptacle and the other end into an appropriate power outlet.
2. Provide power to any OI Analytical autosampler to be connected to the Eclipse by following the instructions in the appropriate autosampler operator’s manual.

Starting the Eclipse

For running the Eclipse without the optional PC software, start the instrument and set up a new user ID using the following instructions. When running the Eclipse with the optional PC software, proceed to “Installing the Optional PC Software” on page 28 of this chapter.

Setting Up a New User ID

The Eclipse arrives from the factory with a default User ID with full permissions and a default Password. Set up additional users with varying permissions using the following steps:

1. Turn on the power switch located on the Eclipse back. The Eclipse 4660 Login dialog box appears (Figure 3.4).

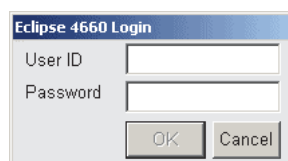

Figure 3.4. Eclipse 4660 Login dialog box

2. Log in by entering the default User ID and Password.
 - Press **User ID** and enter “4660” using the onscreen keyboard. Press **OK**.
 - Press **Password** and enter “4660” using the onscreen keyboard. Press **OK**.
3. Press the **Config** icon to access the General configuration screen, then press the **System** tab to access the System configuration screen. See Chapter 4, “System Configuration Screen” on page 76 for more details.
4. Double-tap **4660 Security**. The Eclipse 4660 Security Login dialog box appears (Figure 3.5).



Figure 3.5. Eclipse 4660 Security Login dialog box

5. Log in by entering the default administrator User ID and Password.
 - a. Press **User ID** and enter “secadmin” using the onscreen keyboard.
 - b. Press **OK**.
 - c. Press **Password** and enter “admin” using the onscreen keyboard.
 - d. Press **OK**. The OIC P&T 4660 – Security dialog box appears (Figure 3.6).

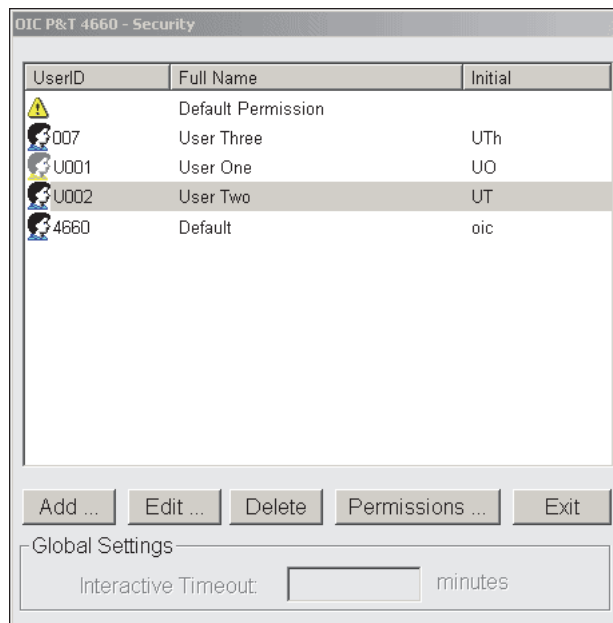

Figure 3.6. OIC P&T 4660 – Security dialog box

- The system automatically uses default permissions to set up new users. Change default permissions by selecting the **Default Permissions** line and pressing **Permissions...** The Default permission settings dialog box appears (Figure 3.7).

NOTE: To adjust a user’s permissions, see Step 8 on page 26.

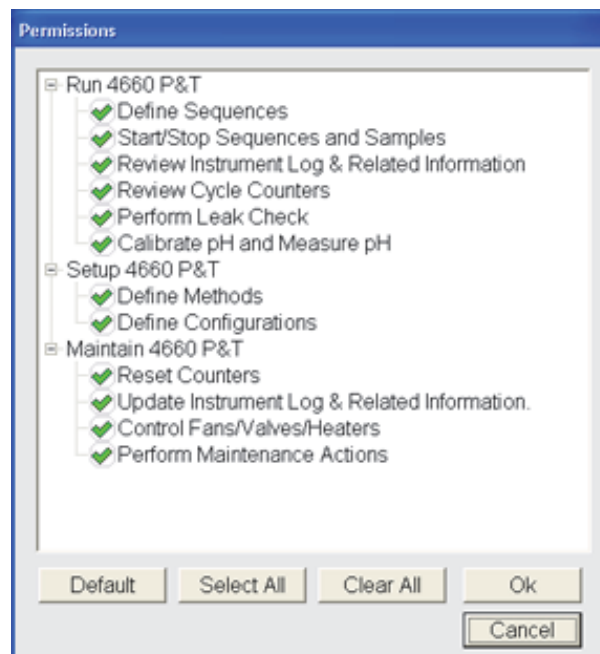

Figure 3.7. Default permission settings dialog box

- Select (?) or deselect (?) default permission options. **Select All** selects all the options, and **Clear All** deselects all the options.
 - Press **OK** to save the changes or **Cancel** to close without saving.
7. Press **Add** to add a new user. The Add New User dialog box appears (Figure 3.8).

The image shows a dialog box titled "Add New User". It contains several input fields: "Login ID:" with the value "005", "Full Name:" with "User 5", "Initials:" with "U5", "Password:" with "*****", and "Confirm:" with "*****". There is a checkbox labeled "Disable" which is currently unchecked. At the bottom right, there are two buttons: "Ok" and "Cancel".

Figure 3.8. Add New User dialog box

- Enter the appropriate information. Press **OK** to save the changes or **Cancel** to close without saving.
8. Modify a user's permissions by selecting the user from the OIC P&T 4660 – Security dialog box and pressing **Permissions**. The Permissions for User dialog box appears (Figure 3.9).

The image shows a dialog box titled "Permissions for user [U002] User Two". It contains a tree view of permissions. The tree is expanded to show three main categories: "Run 4660 P&T", "Setup 4660 P&T", and "Maintain 4660 P&T". Under "Run 4660 P&T", there are five items: "Define Sequences" (checked), "Start/Stop Sequences and Samples" (checked), "Review Instrument Log & Related Information" (checked), "Review Cycle Counters" (checked), and "Perform Leak Check" (checked). Under "Setup 4660 P&T", there are two items: "Calibrate pH and Measure pH" (unchecked) and "Define Methods" (unchecked). Under "Maintain 4660 P&T", there are four items: "Define Configurations" (unchecked), "Reset Counters" (unchecked), "Update Instrument Log & Related Information." (checked), and "Control Fans/Valves/Heaters" (checked). At the bottom, there are five buttons: "Default", "Select All", "Clear All", "Ok", and "Cancel".

Figure 3.9. Permissions for User dialog box

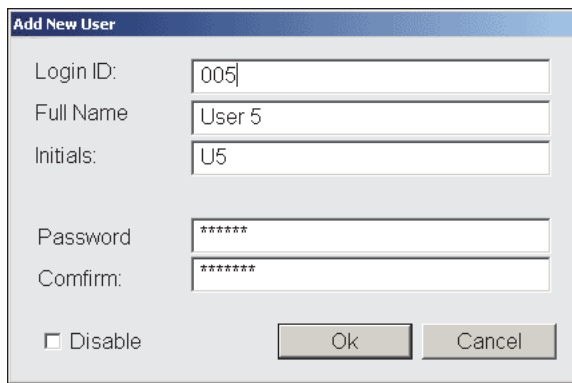
- Select (?) or deselect (?) the user's permissions. **Default** uses the default permissions settings. **Select All** selects all the options, and **Clear All** deselects all the options.
 - Press **OK** to save the changes or **Cancel** to close without saving.
9. Modify or view a user by selecting the user in the OIC P&T 4660 – Security dialog box and pressing **Edit**. The Modify User dialog box appears (Figure 3.10).

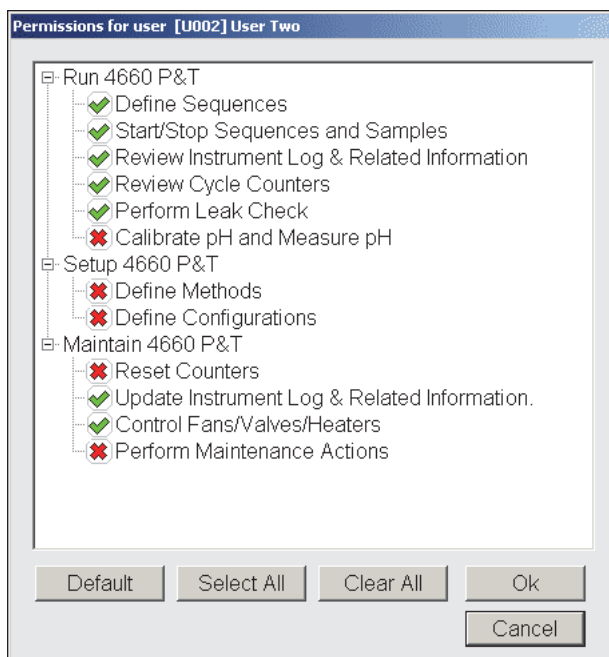
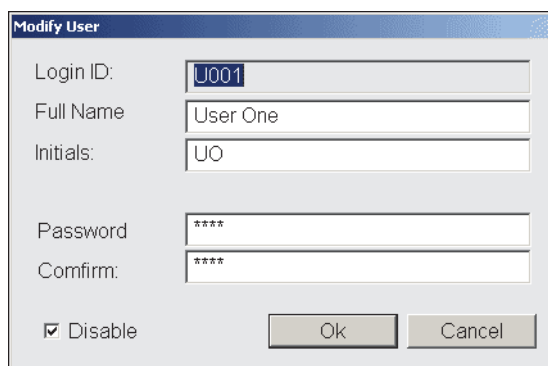

Figure 3.10. Modify User dialog box

- Modify the user's **Login ID**, **Full Name**, **Initials**, or **Password**.
 - Cancel an existing user's permissions without deleting the user by selecting **Disable**.
 - Press **OK** to save the change or **Cancel** to close without saving.
10. Cancel a user by selecting the user in the OIC P&T 4660 – Security dialog box and pressing **Delete**.
- To cancel an existing user's permissions without deleting the user, open the user. The Modify User dialog box appears. Select **Disable**. Press **OK** to save the change or **Cancel** to close without saving.

Installing the Optional PC Software

Before installing the Eclipse PC software, confirm that the PC meets the minimum hardware and software specifications (see Chapter 1, “Specifications” on page 2) and is fully equipped for network access.

1. Verify the user name logged into the PC has administrative privileges to successfully run the install program.
2. Insert the Eclipse CD into the PC’s CD-ROM drive.
3. The “Eclipse Purge-and-Trap Sample Concentrator with Reporter Installation” starts automatically. The four tab options in the window are Installation (Figure 3.11), Manual (Figure 3.12), Registration Card (Figure 3.13), and Vista Documentation (Figure 3.14).
 - a. Select the Installation tab (Figure 3.11) and click the **Install** button to install the Eclipse 4660 PC Software; proceed to step 4 on page 32.



Figure 3.11. Installation tab

- b. Select the Manual tab to view documentation for the product by clicking the Eclipse 4660 User Manual icon; if necessary, download the Adobe PDF viewer provided with the software by clicking the **Install** button at the bottom of the tab.



Figure 3.12. Manual tab

- c. Select the Registration Card tab to complete a product registration card by clicking the Eclipse 4660 Registration icon; if necessary, download the Adobe PDF viewer provided with the software by clicking the **Install** button at the bottom of the tab.



Figure 3.13. Registration Card tab

- d. The installer will set the program shortcut to “Run as Administrator” during the software installation for the user account performing the installation.
 - For detailed instructions, refer to “Setting shortcut properties to ‘Run as Administrator’” on the Vista Documentation tab (Figure 3.14).
 - For further information, refer to “Why you need to set the shortcut to ‘Run as Administrator’”.
 - For compliance information for the Eclipse software package, view the “Windows Vista Compliance Certification” document.
 - If necessary, download the Adobe PDF viewer provided with the software by clicking the **Install** button at the bottom of the tab.



Figure 3.14. Vista Documentation tab

- At the InstallShield welcome screen (Figure 3.15), click **Next** to install the Eclipse software.

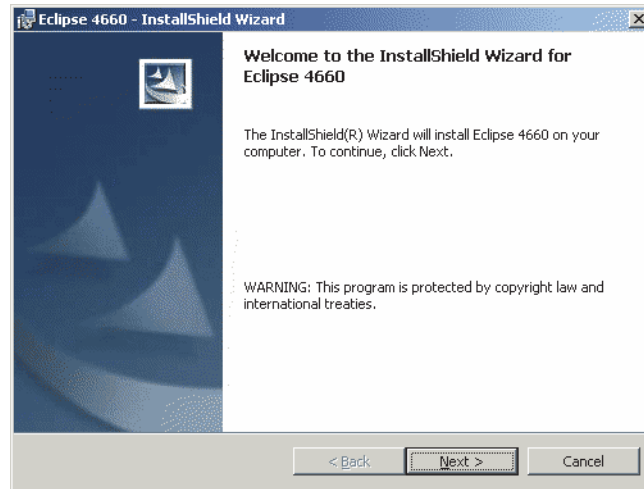

Figure 3.15. Eclipse 4660 InstallShield Wizard screen

- The Customer Information screen (Figure 3.16) appears during installation. Enter the appropriate information.

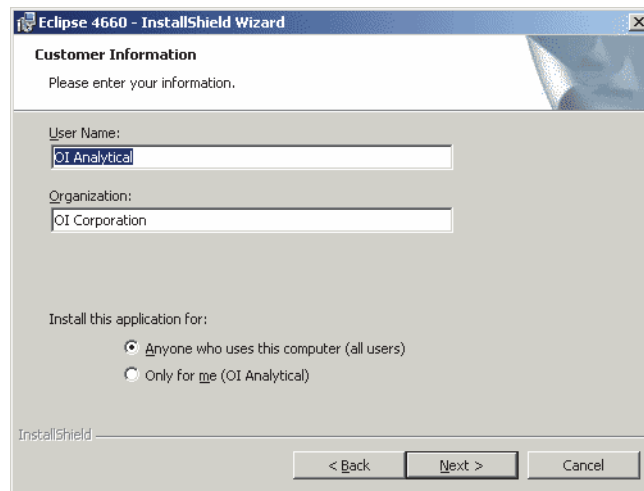

Figure 3.16. Customer Information screen

- After reviewing the settings in the Ready to Install dialog box (Figure 3.17), click **Install**.

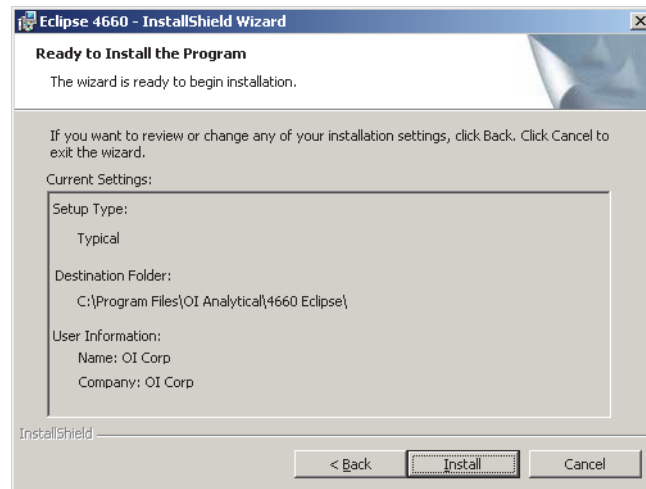

Figure 3.17. Ready to Install screen

- An error message (Figure 3.18) may appear during installation. Click **OK** to acknowledge the message and continue the installation.



Figure 3.18. Eclipse software installation error message

- The installation progress is indicated by the status bar on the next screen (Figure 3.19).

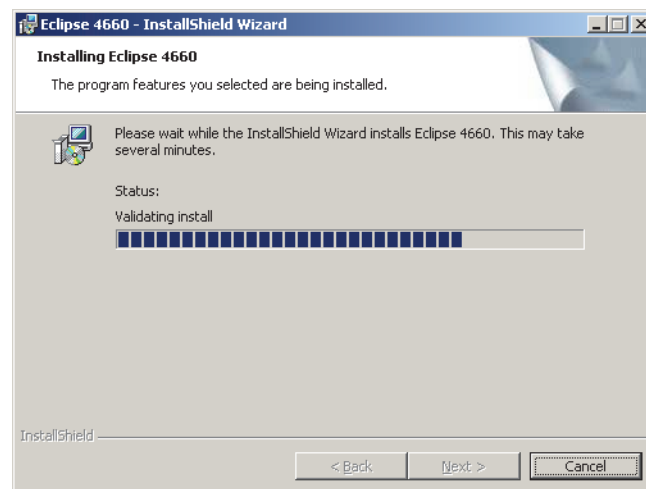

Figure 3.19. Installation progress

9. When the installation completes (Figure 3.18), click **Finish**.

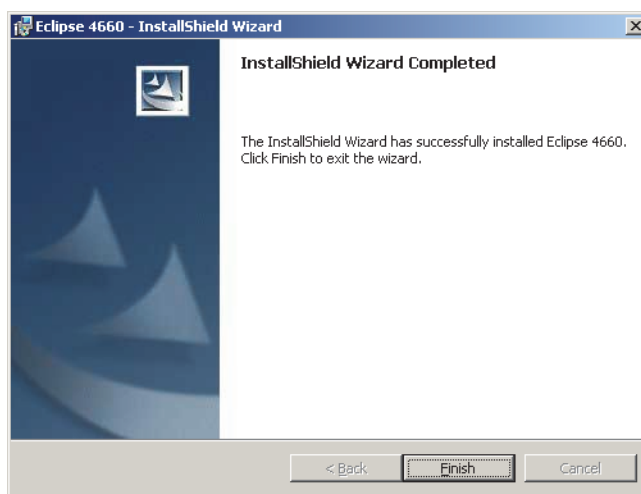

Figure 3.20. Eclipse wizard complete

10. To start the OICLaunchPad, go to File → Programs → OI Analytical → Eclipse 4660 and select “OIC LaunchPad” (Figure 3.21).



Figure 3.21. OICLaunchPad screen

NOTE: Refer to Chapter 14, “Connecting the Eclipse to a Network” on page 206 for instructions on setting up a LAN connection to the Eclipse PC software.

Installing Plumbing Connections

Installing the Sparge Vessel (Sparger)

OI Analytical configures the Eclipse for using a 5-mL frit sparger. Needle sparging requires the needle sparge hardware kit (PN 321615) (see “Installing the Needle Sparger Option” on page 35). Install the frit sparger using the following steps:

NOTE: Use the frosted sparge vessel and the correct 18-mm ferrule for these sparge vessels when using the Foam Buster Option (see Chapter 16, “Replacement Parts” on page 230).

1. Remove the front cover and sparge mount cover.
2. Loosen the ¼" knurled nut on the purge gas inlet tube.
3. Verify a 6-mm Teflon[®] ferrule (PN 224337) is installed.
4. Loosen the 18-mm knurled nut at the bottom of the sparge mount.
5. Verify an 18-mm Teflon[®] ferrule (PN 224204) is installed.
6. Place the new sparger over the purge-drain needle, drain line, and other options and carefully insert the sparger neck into the 18-mm fitting.
7. Insert the 6-mm side of the sparge vessel into the ¼" brass fitting.
8. Tighten both fittings to secure the sparger.

Installing the Needle Sparger Option

Use a needle sparger for analyses performed on soils, sludges, or other solids. Needle sparging also may be used for liquids that foam. Samples can be purged at ambient temperature or at elevated temperatures as required by some methods using the Infra-Sparge[™] Sample Heater option. Needle sparging requires the needle sparge hardware kit (PN 321615).

Installing the Needle Sparger on the Four-Way Injection Valve

1. Remove the front and sparge mount covers.
2. Remove the frit sparger from the Eclipse.
 - a. Loosen both fittings that secure the sparger.
 - b. Lower the sparger until it clears the needle and other options.
3. Remove the purge-drain needle from the bottom of the four-way injection valve by loosening the bushing.
4. Connect the frit-style purge gas inlet tube (PN 321045) to the needle-style purge gas inlet tube (PN 321661) provided.

5. Disconnect the fitting or fitting plug from the nine o'clock (left) port.
6. Connect the needle-style purge gas inlet tube (PN 321661) to the nine o'clock port and finger-tighten the fitting.
7. Install the needle sparge purge needle (PN 321651) into the bottom of the injection valve. Tighten the needle assembly bushing.
8. If required for the application, install the Mud-Dawg™ by sliding it over the purge needle following the instructions provided with the Mud-Dawg.
9. Slide the appropriate needle sparger over the purge needle into the 18-mm knurled nut and finger-tighten.
10. Replace the front and sparge mount covers.

Installing the Needle Sparger on the Three-Way Injection Valve

1. Remove the front and sparge mount covers.
2. Remove the frit sparger from the Eclipse.
 - Loosen both fittings that secure the sparger.
 - Lower the sparger until it clears the needle and other options.
3. Remove the purge-drain needle from the bottom of the three-way injection valve by loosening the bushing.
4. Connect the frit-style purge gas inlet tube (PN 321045) to the needle-style purge gas inlet tube (PN 321661) provided.
5. Disconnect the drain line from the injection valve> The line may loosely rest unconnected.
6. Loosen the two screws holding the valve bracket to the Eclipse.
7. Slide the valve bracket up, leaving the screws attached to the Eclipse. Loosen and slide the three-way injection valve forward to remove it from the bracket.
8. Loosen the injection valve from the bracket. Rotate the valve 90° clockwise.
9. Remove the Luer-Lok injection adapter from its old position and thread the Luer-Lok fitting into the forward port on the injection valve.
10. Connect the needle-style purge gas inlet tube to the nine o'clock position on the injection valve and finger-tighten.
11. Install the needle sparge purge needle (PN 321651) into the bottom of the three-way injection valve. Tighten the needle assembly bushing.

12. If required for the application, install the Mud-Dawg by sliding it over the purge needle following the instructions provided with the Mud-Dawg.
13. Slide the appropriate needle sparger over the purge needle into the 18-mm knurled nut and finger-tighten.
14. Replace the front and sparge mount covers.

Installing Gas Connections

1. Connect the Q/i" purge gas line (PN 111427) between the purge gas source and the receptacle marked "Purge Gas Inlet" on the Eclipse back. Use the standard Q/i" stainless steel Valco® nut and ferrule provided or use the Swagelok® nut (PN 128108) and ferrule (PN 128082) in the Eclipse startup kit (Figure 3.22).

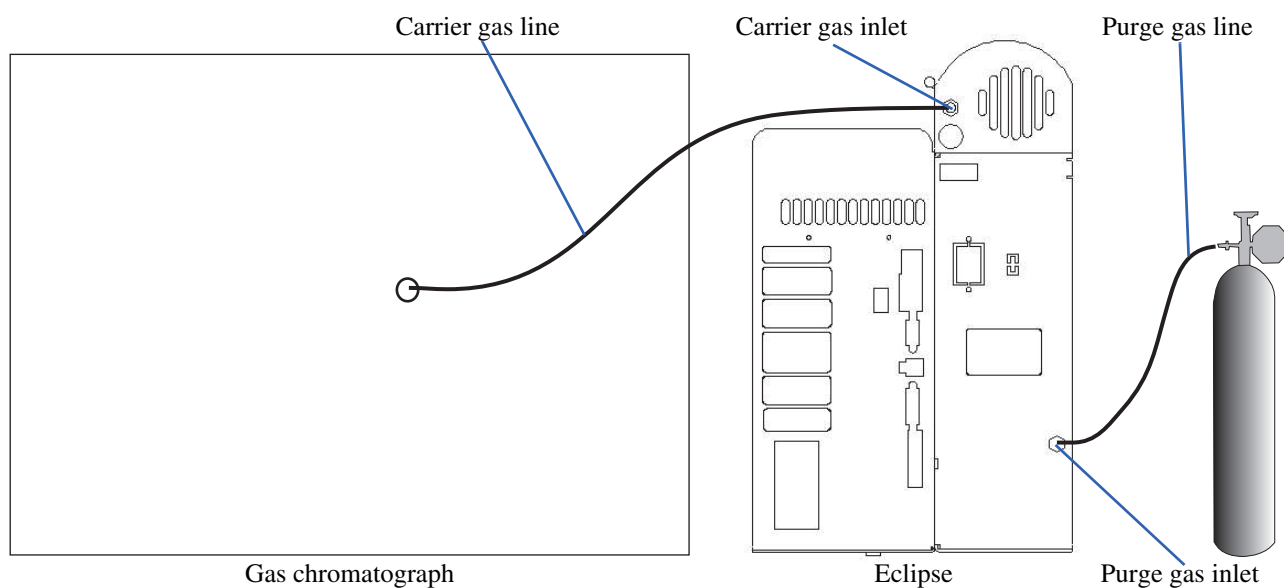

Figure 3.22. Connecting the gas lines

2. Connect the carrier gas line between the GC flow controller and the carrier gas inlet on the Eclipse back. The Q/qy" nut (PN 169640) and ferrule (PN 112433) attached to the carrier gas line connect to the carrier gas inlet on the Eclipse.

Connecting the Eclipse Transfer Line to the GC

Connect the transfer line attached to the Eclipse to the GC via one of the following configurations:

- Through the split/splitless injector
- Directly to the column via a union
- Through the OI Analytical Low-Dead-Volume Injector™

Connecting the Eclipse Transfer Line to the Split/Splitless Injector

The following instructions describe connecting the transfer line to an Agilent® 6890 or 7890 GC split/splitless injector. Use the same instructions for connecting the line to other manufacturer's GCs, but some modifications to the following instructions and additional hardware and installation kits may be required.

CAUTION

For the Agilent 6890 or 7890 GC split/splitless inlet, always cut the Q/qy"-O.D. line. Do not cut the 2-mm O.D. line. Depending upon where the GC was manufactured, the 2 mm and Q/qy" lines may be in the relative positions shown in Figure 3.23 or Figure 3.24, or they may be reversed.

1. Locate the two gas lines visible at the top of the split/splitless inlet. On the Agilent 6890 or 7890 GC, the septum purge line is 2 mm in diameter and the carrier gas line is Q/qy" (see Figure 3.23 for an Agilent 6890 GC or Figure 3.23 for an Agilent 7890 GC).

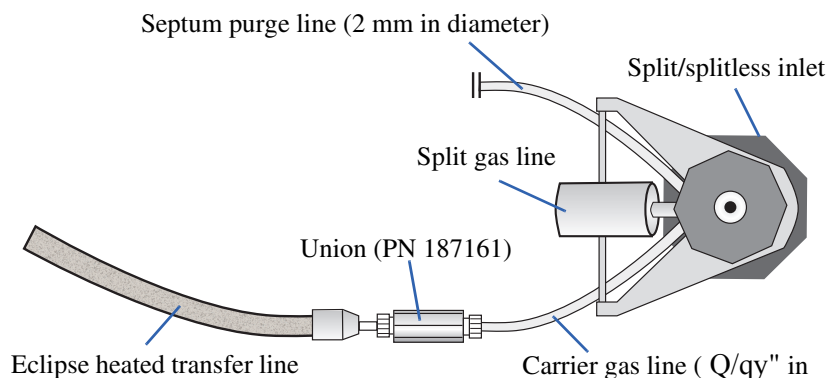

Figure 3.23. Top view of a split/splitless inlet for an Agilent 6890 GC

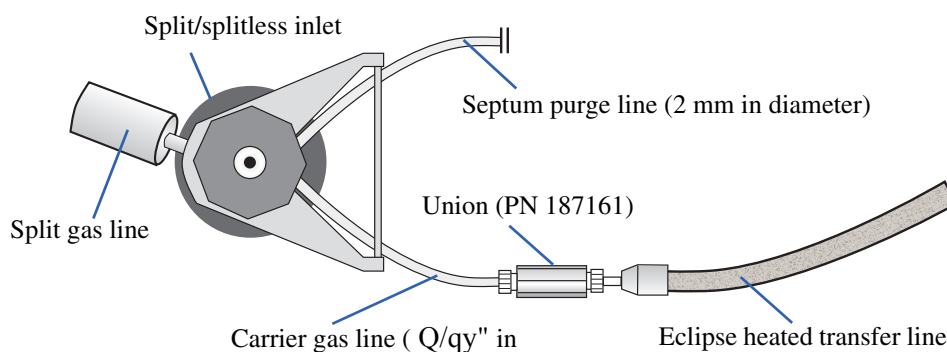

Figure 3.24. Top view of a split/splitless inlet for an Agilent 7890 GC

2. Cut the carrier gas line approximately 4 cm (1.5") from where it enters the body of the split/splitless inlet.
3. Install a stainless steel union (PN 187161) included in the startup kit onto the short length of the cut carrier gas line protruding from the split/splitless inlet.

NOTE: Use the stainless steel union (PN 291625) to connect to a Shimadzu GC.

4. Connect the heated transfer line from the Eclipse to the union.

NOTE: If possible, place the transfer line and union under the mounting bracket of the autoinjector, allowing normal use of the autoinjector. Cover the transfer line end and the union with insulation to avoid heavier compounds condensing in this area during desorption.

5. The other end of the cut carrier gas line connects to the GC's manual or EPC flow control module. Route this line to exit the GC back. Connect it to the Q/qy" carrier gas inlet on the Eclipse back using the nut and ferrule included in the startup kit.

NOTE: A short length of tubing included in the kit may need to be added to reach the Eclipse back.

Connecting the Transfer Line Directly to the Column

If desired, connect the transfer line directly to the GC column using an appropriate low-volume union.

1. Route the transfer line through an available opening on the GC.
2. Connect the transfer line to the column using an appropriate union.
3. Pack the opening with insulation. Verify the transfer line or insulation does not enter the GC oven to avoid damage to the line if the GC oven heats to high temperatures.

Connecting the Transfer Line to the Low-Dead-Volume Injector™

Refer to the "Low-Dead-Volume Injector™ Installation and Maintenance Guide" (PN 236414) for instructions on connecting the transfer line.

Connecting the Autosampler to the Eclipse

Follow the installation instructions in the "*Model 4551A Purge-and-Trap Water Autosampler Operator's Manual*" or the "*Model 4552 Purge-and-Trap Water/Soil Autosampler Operator's Manual*."

Setting the Purge Gas Pressure and Flow Rate

Set the system pressure to 20–24 psi and the purge flow rate to 40 mL/minute (for most methods) using the following steps:

1. Turn on gas flow to the Eclipse.
2. Plug the purge gas vent using the plug provided in the Eclipse startup kit (PN 248864).
3. Press the **Maint** icon to access the Maintenance screen (Figure 3.25).

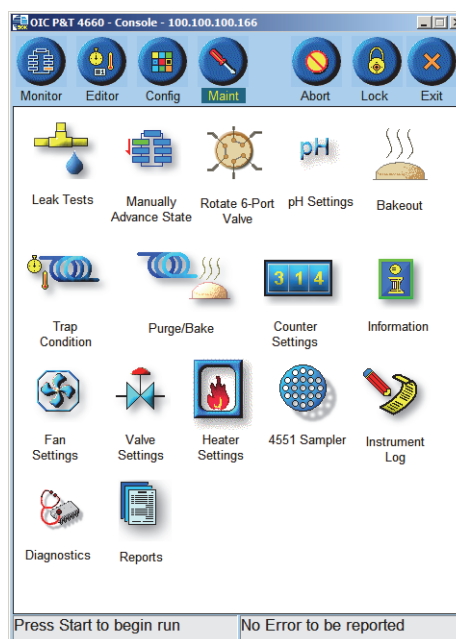

Figure 3.25. Maintenance screen

4. Press the **Manually Advance State** icon. The Maintenance: Change State dialog box appears (Figure 3.26).

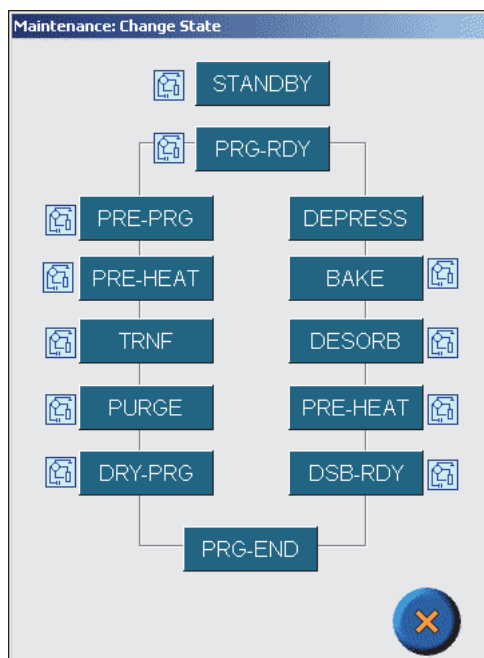

Figure 3.26. Maintenance: Change State dialog box

5. Press **PURGE** to enter the purge state. Press ? to exit the dialog box.
 6. Press the **Monitor** icon to access the Status screen.
 7. Observe the purge gas indicator as the purge gas pressure climbs. The pressure should be 20–24 psi.
 - If the pressure is less than 20 psi, adjust the purge gas pressure using the purge pressure regulator knob located on the instrument front.
 - If the pressure is greater than 24 psi, press **Abort** to exit the purge state.
 - Adjust the purge gas pressure down using the purge pressure regulator knob.
 - Access the Maintenance: Change State dialog box again. Press **Purge** to enter the purge state. Press ? to exit the dialog box.
 - Observe the purge gas pressure from the Status screen and readjust the pressure if necessary.
- NOTE:** Adjust the pressure slowly, allowing the system time to equilibrate. The system only pressurizes at 40 mL/minute.
8. Press **Abort** to exit the state.
 9. Remove the plug from the purge gas vent.

10. Access the Maintenance: Change State dialog box again. Press **Purge** to enter the purge state.
11. Measure the purge gas flow from the purge gas vent using a flow meter (Figure 2.3). The purge gas flow should be ~40 mL/minute for most methods.
12. If the purge gas flow is not at the desired rate, adjust the flow rate using the purge flow regulator knob located on the instrument front.
13. Press **Abort** to exit the purge state.

Performing a Leak Test

1. Press the **Maint** icon to access the Maintenance screen (Figure 3.25).
2. Press the **Leak Test** icon. The Maintenance: Leak Tests dialog box appears (see Figure 3.27).

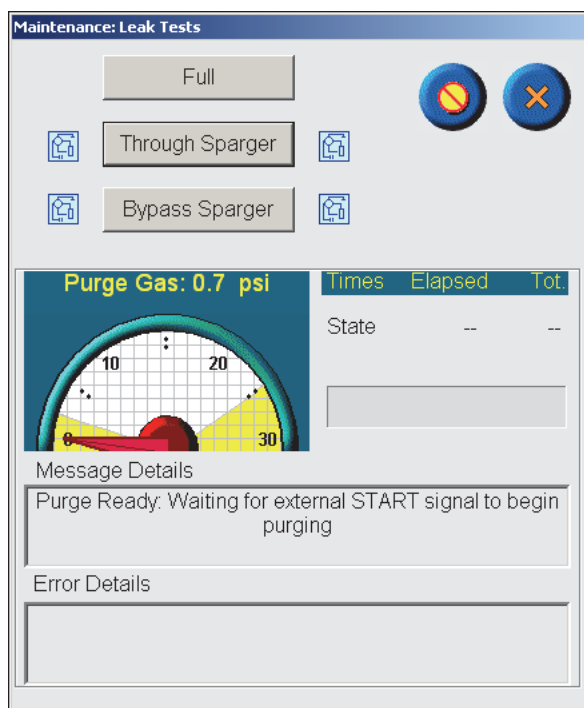

Figure 3.27. Maintenance: Leak Tests dialog box

3. Press **Full** to perform a full system leak test. For more information on the leak test, see Chapter 6, “Leak Tests” on page 102.
4. If a leak is detected, an error message appears that specifies the leak test stage where the error occurred. Correct the problem. Recheck the purge gas pressure and flow rate (see Chapter 3, “Setting the Purge Gas Pressure and Flow Rate” on page 40 of this chapter) and perform another full leak check.

Changing and Conditioning the Trap

OI Analytical installs the #10 trap in the factory. If desired, install a different trap using the instructions in Chapter 6, “Changing the Trap” on page 123.

Before using a trap for the first time (or if the Eclipse sits idle for a period of time without cycling), condition the trap using the instructions in Chapter 6, “Conditioning the Trap” on page 124.



Chapter 4 Eclipse User Interface

This chapter describes the touchscreen user interface and provides information on the menus, screens, and commands used to control the Eclipse.

The optional Eclipse software can be installed to control the Eclipse(s) connected to a PC via an Ethernet or LAN connection. The Eclipse software looks and operates the same as the touchscreen user interface, except the inputs are made through the PC's keyboard and mouse.

Main Menu Icons and Screens

The main menu icons and screens provide easy access to primary functions and commands.

Table 4.1 shows the complete menu and screen structure of the Eclipse. Access a screen by pressing its main menu icon, then pressing the screen's named tab.

Table 4.1. Main menu icons and screens







Main Menu Icon	Main Menu Icon Title	Screen	Comment
	Monitor	Status Temperature Active Method Active Sequence	Accesses detailed, real-time conditions and settings, including active method and sequence information. Single-touch icons located on the lower part of the screens provide access to additional graphical displays and important functions such as Start, Pause, Priority Sample, and Drain.
	Editor	Method Sequence	Generates new or edits existing methods or sequences.
	Config	General Configure Basic, Advanced, Autosampler, Options Trap System	Defines and saves instrument configurations.

Table 4.1. Main menu icons and screens

Main Menu Icon	Main Menu Icon Title	Screen	Comment
	Maint	Leak Tests Manually Advance State Rotate 6-Port Valve pH Settings Bakeout Trap Condition Purge/Bake Counter Settings Information Fan Settings Valve Settings Heater Settings 4551 Sampler Instrument Log Diagnostics Reports	Accesses maintenance functions.
	Abort		Stops a current run and resets method and sequence information.
	Lock		Prevents unauthorized access or use of the Eclipse. Press Lock again to unlock the Eclipse.
	Exit		Shuts down and exits the program.

The status bar (Figure 4.1) shows the instrument's current status. It appears at the bottom left of the touchscreen and remains visible from any Eclipse screen. Press the status bar to view a more detailed status message.

The error bar next to the status bar displays error messages. When an error message appears, an audible alarm sounds if this option is activated (see "Advanced Configure Screen" on page 66 in this chapter for more information) and the error bar color can change. Press the error bar to view a more detailed error message display.

Status Screen

The Status screen displays detailed, real-time conditions and settings, including the current state, sequence status, trap and sample temperatures, pH reading, and electronic pressure data (Figure 4.1). The Status screen also includes single-touch icons that access additional graphical displays and important functions such as Start, Pause,

Priority Sample, and Drain. Access the Status screen by pressing the **Status** tab from the **Monitor** icon.

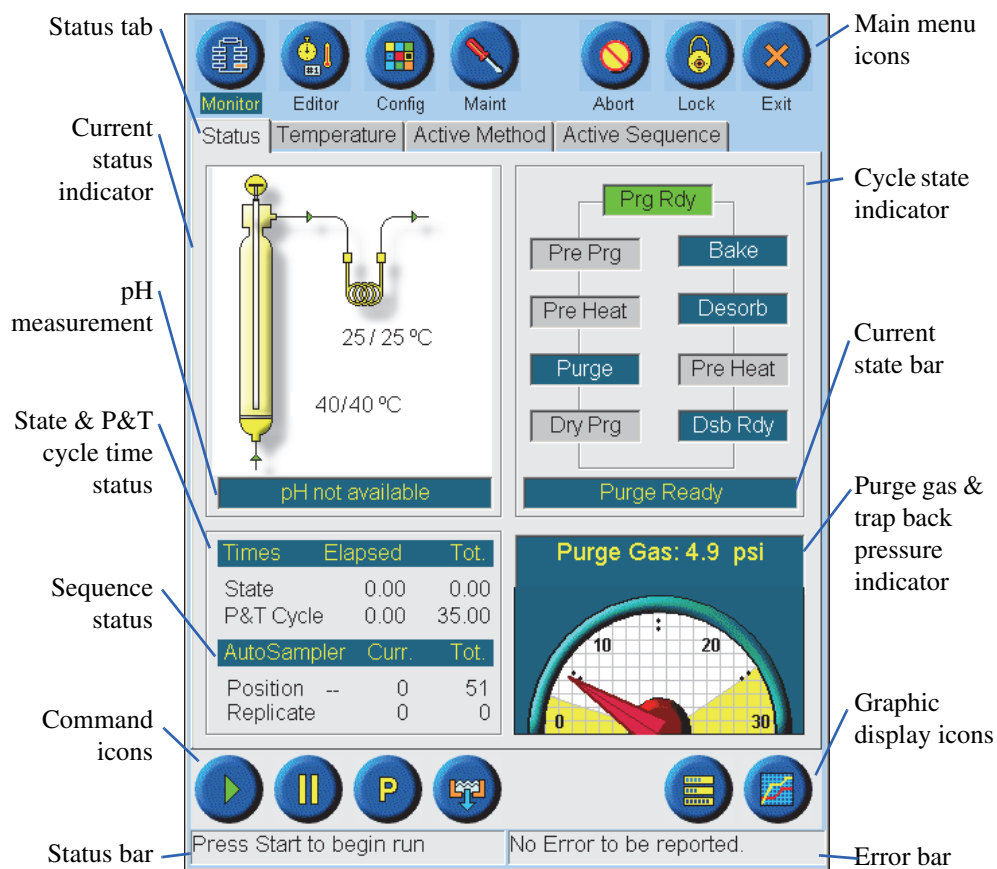

Figure 4.1. Status screen

Current Status Indicator

The current status indicator graphically displays changes in the current state, and indicates the sample and trap temperatures and sample pH (if the *pHDetect* module is installed). Figure 4.2 shows graphical displays of different states.

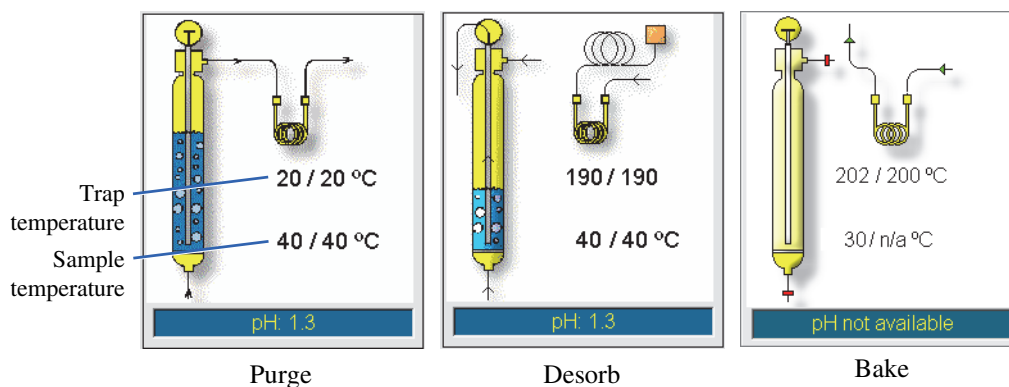

Figure 4.2. Current status indicator graphically displays changes in the current state

The temperature display shows the following:

- Current trap temperature/Trap temperature set point (°C)
- Current sample temperature/Sample temperature set point (°C)

NOTE: The current sample temperature and sample temperature set point information is only available if the Infra-Sparge™ Sample Heater option is installed.

If the *pHDetect* module is installed, the pH measurement shows the pH reading of the last measured sample. If the *pHDetect* module is not installed, the pH measurement displays “pH not available.”

Cycle State Indicator

The cycle state indicator displays the Eclipse’s states (Figure 4.3). The cycle moves in a counterclockwise direction.

- Blue color indicates an activated state during a run.
- Green color indicates the current state. The current state also appears in the bar below the cycle state indicator. If the operator pauses the run, the current state bar shows “XXX—Paused”, where XXX is the current state.
- Grey color indicate an inactivated state during a run.

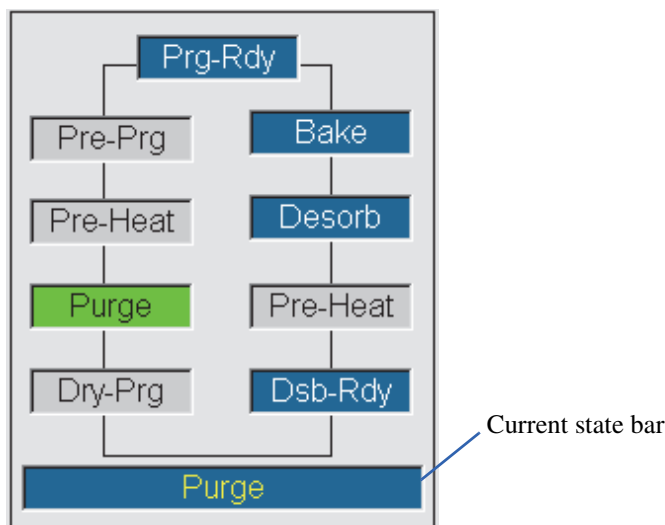

Figure 4.3. Cycle state indicator

State Time, P&T Cycle Time, and Sequence Status

The state time status shows the current state’s elapsed time (minutes) or how long the state has run, and the state’s total time (minutes) or the entire time the state takes to complete (Figure 4.4).

The P&T cycle time status shows the current P&T cycle’s elapsed time (minutes) or how long the cycle has run, and the cycle’s total time (minutes) or the entire time the cycle takes to complete.

The sequence status indicates the actual vial position in the autosampler of the currently processed sample (in parentheses), the vial’s relative position in the active sequence,

and the total number of samples included in the active sequence. The current replicate number of the present sample is indicated, as well as its total number of replicates.

Times	Elapsed	Tot.
State	6.60	10.00
P&T Cycle	14.00	24.00
AutoSampler	Curr.	Tot.
Position (1)	1	21
Replicate	1	2

Actual vial position Relative vial position

Figure 4.4. State time, P&T cycle time, and sequence status

For example, an active sequence contains two lines:

Line 1: Actual vial position 5–8

Line 2: Actual vial position 3–4

At the sequence start, the Position reads: (5) 1 6.

Purge Gas and Trap Backpressure Indicators

The purge gas and trap pressure indicators graphically display the current purge gas pressure (psi) (Figure 4.5) and the trap backpressure (psi) (Figure 4.6). An electronic pressure sensor in the sample pathway measures the pressure. Press the title above the pressure gauge to toggle between the purge gas and trap backpressure readings.

NOTE: The trap backpressure indicator is a future option that is not included with the standard unit. If the trap backpressure indicator option is not installed, “Trap: N/A” displays when pressing **Trap**.

NOTE: During normal operation, be sure the purge gas indicator is visible.

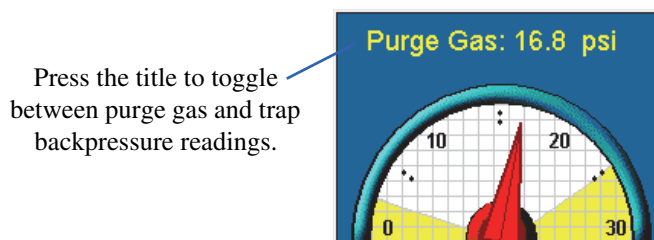

Figure 4.5. Purge gas pressure indicator

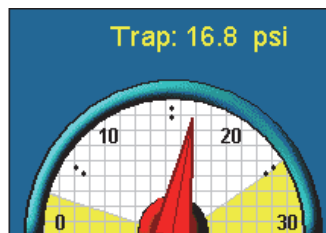

Figure 4.6. Trap backpressure indicator

Command Icons

Command icons are single-touch icons that quickly access important instrument functions. View and access these icons from any Monitor screen.



Start begins a run and its corresponding sequence, if configured.



Pause suspends the run. Press **Pause** again to resume the run at the point where it paused.



Priority Sample accesses the Enter Priority Sample dialog box to easily insert high priority samples into the active sequence without stopping the running sequence. This feature is only active for the Model 4551A configuration.



Drain enables immediate draining and empties the sparge vessel.

Graphic Display Icons

Graphic display icons access sequence progress and temperature displays. View and access these icons from any Monitor screen.



Progress access the Progress Bar popup, which displays bar graphs of the sequence and cycle status.



Temperature access the Temperature Graph popup, which displays graphs of trap, sample and water management temperatures.

Progress Bar Popup

The Progress Bar popup shows bar graphs that visually display the real-time sequence status (Figure 4.7).

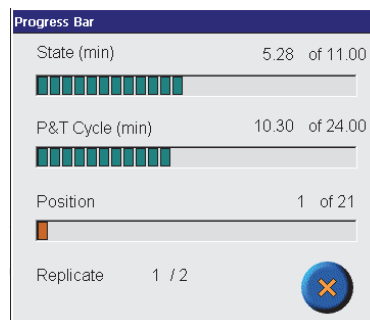

Figure 4.7. Progress Bar popup

State (min)

Displays the current state's elapsed time (minutes) or how long the state has run, and the state's total time (minutes) or the time the state takes to complete. The bar graph shows the state's progress.

P&T Cycle (min)

Displays the current P&T cycle's elapsed time (minutes) or how long the cycle has run, and the cycle's total time (minutes) or the time the cycle takes to complete. The bar graph shows the cycle's progress.

Position

Displays the autosampler position of the current sample and the total number of samples included in the active sequence. The bar graph shows the autosampler sequence progress (for Model 4551A Autosampler only).

Replicate

Displays the current replicate number of the present sample, as well as its total number of replicates

Temperature Graph Popup

The Temperature Graph popup shows a graph that visually displays the real-time temperature status of the trap, sample, and water management (Figure 4.8). Add or remove temperature readings from the graph by checking or unchecking the three options.

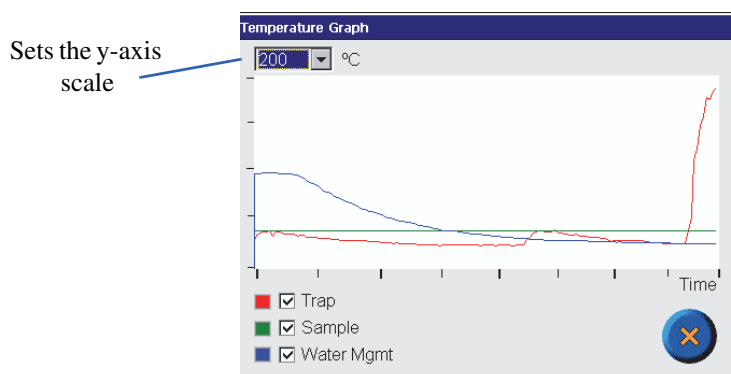

Figure 4.8. Temperature Graph popup

Temperature °C	Sets the y-axis maximum of the graph. The y-axis scale setting options are 100, 200, 300, 400, and 500. Press ? and select the desired scale option.
Trap	Enables trap temperature display. Trap temperatures are shown in red.
Sample	Enables sample temperature display. Sample temperatures are shown in green.
Water Mgmt	Enables water management temperature display. Water management temperatures are shown in blue.

Status Bar and Error Bar

The status bar shows the current instrument status and is always visible from any Eclipse screen. Press the bar to view the Status Message popup for detailed status information.

The error bar displays error messages. When an error message appears, an audible alarm sounds if **Enable Audible Alarms** is chosen in the configuration (see “Advanced Configure Screen” on page 66 in this chapter). Press the error bar for the Error Message popup for more detailed error information. See Chapter 12, “Eclipse Error Messages” on page 189 for error messages and their descriptions.

To clear an error message, press **Abort**. If the error message recurs, the error still exits.

NOTE: All error message except “Sample cover open” and “Trap cover open” must be cleared by pressing **Abort**.

NOTE: If a heater error occurs, the error message displays on the screen. All heater errors become written in the run log.

Temperature Screen

The Temperature screen displays the current and set point temperatures of all heated zones (Figure 4.9). Access the Temperature screen by pressing the **Temperature** tab from the **Monitor** icon.

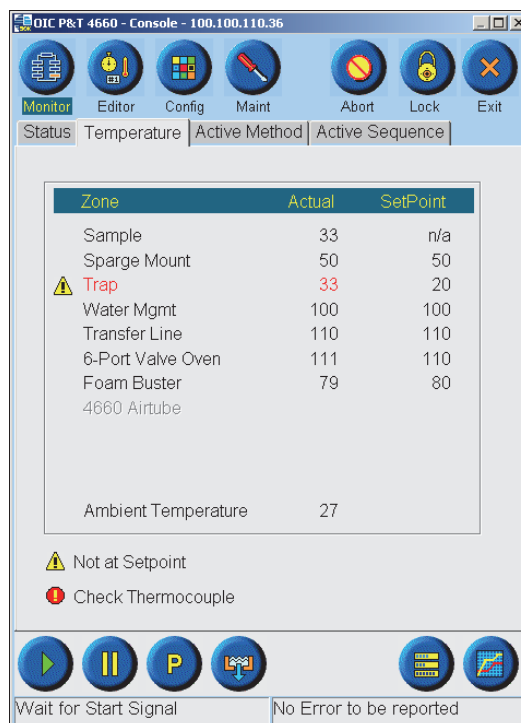

Figure 4.9. Temperature screen

- If an area's temperature is not within 5 °C of its set point, the Not at Setpoint warning appears.
- The Check Thermocouple warning appears if the zone's thermocouple fails, such as an open thermocouple or an indicated value of 1,000 or greater.
- The Zone Not Heating warning appears when the particular zone temperature does not reach its set point or if the heating rate is too slow. The particular zone becomes disabled.

NOTE: When a trap heater error or a sample heater error occurs during a run, the run stops. If the valve oven, transfer line, sparge mount, or water management heaters are not within 5 °C of their set points, the Eclipse remains in standby and does not advance to purge ready.

NOTE: When the trap and water management temperature set points are less than ambient temperature (recommended settings), the Eclipse cools these devices to the lowest possible temperature. Once stabilized at these temperatures, the unit continues to cycle. Under these conditions, the Temperature screen displays the Not at Setpoint warning for these zones and the unit continues to cycle. This is normal for the instrument.

Also, the command and graphic display icons and the status and error bars can be accessed from the Temperature screen.

Active Method Screen

The Active Method screen displays the currently loaded method (Figure 4.10). Access the Active Method screen by touching the **Active Method** tab from the **Monitor** icon.

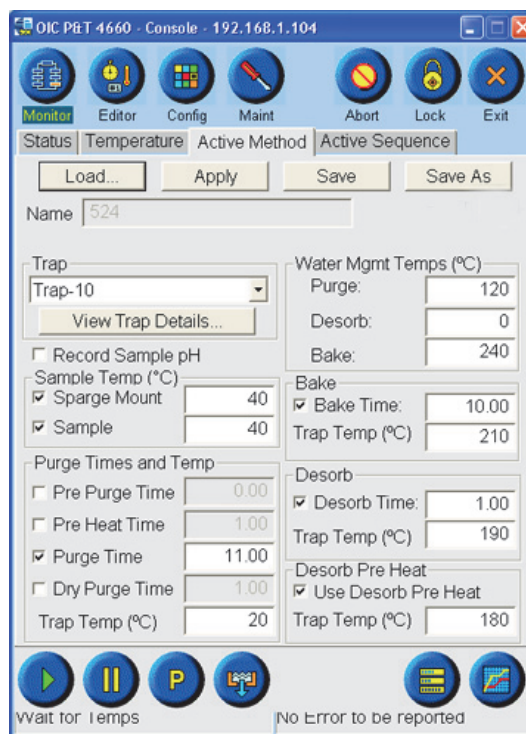

Figure 4.10. Active Method screen

Designate the active method from the currently active sequence, or designate an active method from the Active Method screen if the instrument is set to any configuration except the Model 4551A. Once a method becomes the active method, it can no longer be edited from the Method Editor screen.

To clear an active method, either clear the active sequence from the Active Sequence screen or designate another active method from the Active Method screen if the instrument is set to any configuration except the Model 4551A.

If a sequence is running, the Active Method screen's functions can no longer be accessed and its features are ghosted or grayed out. Continue to access command and graphic display icons, and the status and error bars from the Active Method screen.

NOTE: Activate an operational parameter by touching the checkbox. Change a set point by pressing the numeric field and entering the new setting.

NOTE: See Chapter 13, “Recommended Settings and Configurations” on page 201 for more information.

NOTE: The functions and fields in the Active Method screen are available only when the Model 4551A configuration is *not* active or if the Model 4551A sequence has been cleared.

Load	Activates a method.
Apply	Applies changes made to an active method. The changes are not saved in the method file. NOTE: If Apply is not pressed, the system ignores any changes made.
Save	Saves changes made to the active method in the method file.
Save As	Saves changes made to the active method in a new method file.
Name	Displays the active method name.
Trap	Displays the active method’s trap name. Change the trap by selecting a new trap from the dropdown. Press View Trap Details... to display the trap’s settings and parameters. NOTE: When selecting a trap, the desorb preheat temperature field automatically fills with the recommended setting. NOTE: Edit trap parameters in the Trap Configuration screen (see “Trap Configuration Screen” on page 74 in this chapter).
Record Sample pH	Enables pH measurement with the <i>pHDetect</i> module. NOTE: The Enable pH Sensor checkbox in the Options Configure screen must also be selected (see Chapter 7, “Installation” on page 139).
Sample Temp (°C)	Sets the Sparge Mount and Sample temperatures. Enter the desired temperature set points for these zones. The sparge mount and sample temperature range from 1 °C to 200 °C.
Purge Times and Temp	Enables these states and edits their set points: Pre-Purge Time , Pre-Heat Time , Purge Time , Dry Purge Time ; and enables measuring and edits Trap Temp (°C) set point. The time ranges from 0.00 to 999.99 minutes. The trap temperature range varies with the trap type.

Water Mgmt Temps (°C)	<p>Enables water management heating. Enter the desired water management temperature set points during Purge, Desorb, and Bake states. The purge, desorb, and bake temperature ranges from 1 °C to 270 °C.</p> <p>NOTE: For most applications set the water management's desorb temperature to "0" to ensure the maximum cooldown temperature. The temperature decreases to 1 °C above ambient and then continues with the cycle. The following are standard parameters for water temperatures:</p> <ul style="list-style-type: none">• 110 °C in purge• 0 °C in desorb• 240 °C in bake
Bake	<p>Enables and sets the Bake Time and the Trap Temp (°C) set point during bake. The bake time ranges from 0.00 to 999.99 minute. The trap temperature range varies with the trap type.</p>
Desorb	<p>Enables and sets the Desorb Time and the Trap Temp (°C) set point during desorb. The desorb time ranges from 0.00 to 999.99 minute. The trap temperature range varies with the trap type.</p>
Desorb Preheat	<p>Enables trap heating before desorb. Enter the desired Trap Temp (°C) set point for desorb preheat. The recommended desorb preheat trap temperature is 10 °C less than the desorb temperature.</p>

Active Sequence Screen

The Active Sequence screen displays the currently loaded sequence (Figure 4.11). Access the Active Sequence screen by touching the **Active Sequence** tab from the **Monitor** icon.

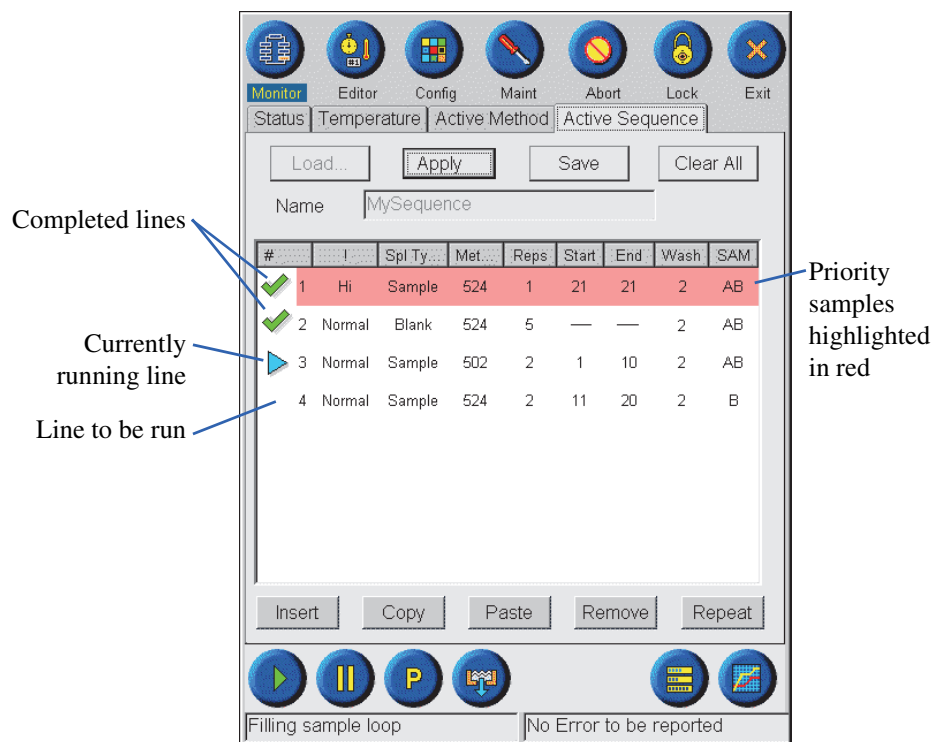

Figure 4.11. Active Sequence screen

Edit an active sequence through the Active Sequence screen only if the run has not started or if the samples of a given line have not completed. For example, line 4 of the active sequence shown in Figure 4.11 can be edited. Only the End position in line 3 can be edited. Lines 1 and 2 cannot be edited. For more information of editing sequences, see Chapter 5, “Using Sequences” on page 89.

Select a line to edit by pressing its line #. Edit a line’s specific parameters by pressing on that parameter. A dropdown menu appears listing the parameter’s options.

To add priority samples to the active sequence, press the **Priority Sample** icon. Alternatively, add priority samples by inserting a new line set to high priority. See Chapter 5, “Inserting Priority Samples” on page 92 for more details.

NOTE: Sequences can only be programmed in the Eclipse for the Model 4551A Autosampler. If using the Model 4552 Autosampler, program sequences using the autosampler, not the Eclipse.

Load

Loads a previously saved sequence, which then becomes the active sequence.

Apply	Applies changes made to an active sequence. The changes are not saved in the sequence file.
Save	Saves changes made to the active sequence in the sequence file. NOTE: Changes made to the active sequence using Apply or Save become logged as sequence changes in the instrument log.
Clear All	Removes the active sequence. All methods are then accessible in the Method Editor screen.
Name	Displays the active sequence name.
Line #	Displays the sequence line number.
!	Sets the priority of a sequence line: Normal or Hi . High priority lines are highlighted red and run before normal samples. NOTE: Be sure to match sequence order or priority status changes to changes in the GC data system sequence.
Spl Type	Sets the analysis type to be performed: Sample or Blank .
Method	Sets the sequence line's method. When the sequence loads, the top sequence line's method becomes the active method.
Reps	Sets the number of replicates per vial to be analyzed.
Start	Sets the starting autosampler vial position.
End	Sets the ending autosampler vial position. NOTE: Start and End are not needed for the Blank sample type. NOTE: The autosampler vials cannot be run in a nonsequential manner. The ending autosampler vial position cannot be set for a location before the starting vial position. To skip vials, Insert a new line and set the starting vial position for the next desired sample.
Wash	Sets the number of washes or rinses per vial when using the Model 4551A Autosampler.

SAM

Enables the Standard Addition Module (SAM) (for the Model 4551A Autosampler only).

- **A** indicates SAM A is active.
- **B** indicates SAM B is active.
- **A/B** indicates both SAM A and SAM B are active.
- **None** indicates the SAM is not active.

Insert, Copy, Paste, Remove, and Repeat

Simplifies creating and editing sequences by easily adding and deleting sequence lines.

- **Insert** adds a line at the bottom of the sequence if no line is selected, or adds a line below the selected line.
- **Copy** duplicates a selected line to the clipboard.
- **Paste** inserts the copied line from the clipboard at the bottom of the sequence or below the selected line.
- **Remove** clears selected lines from the sequence.
- **Repeat** duplicates the selected line and adds a line below. It copies and pastes all the information and increases the start position by one (Figure 4.12).

Repeat Line 1
results in Line 2

#	I	Spl...	Met...	Reps	Start	End	Wash	SAM
1	Nor...	Sa...	502	2	1	10	0	None
2	Nor...	Sa...	502	2	11	11	0	None

Figure 4.12. Repeating a line in a sequence

Method Editor Screen

Generate new or edit existing methods with the Method Editor screen (Figure 4.13). Access the Method Editor screen by touching the **Method** tab from the **Editor** icon.

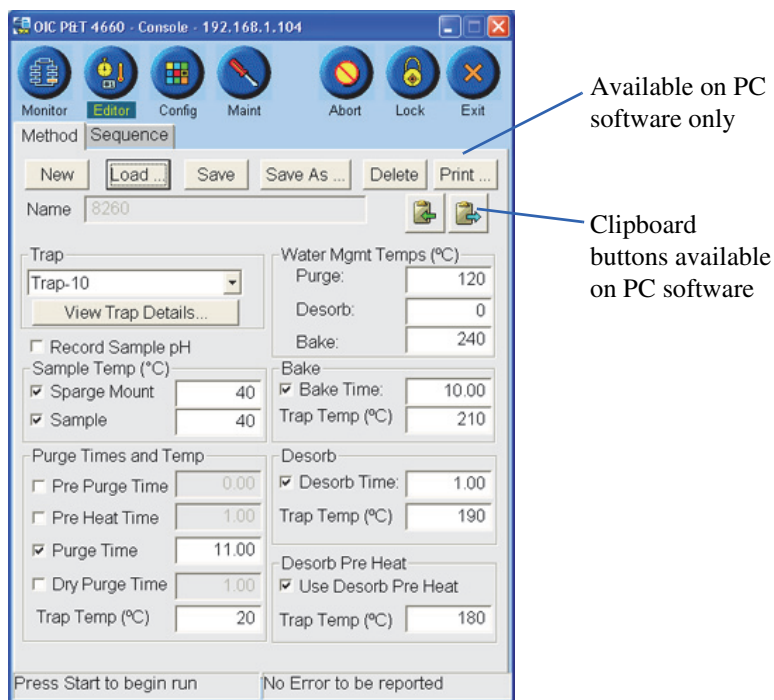

Figure 4.13. Method Editor screen

NOTE: Activate an operational parameter by touching the checkbox. Change a set point by pressing the numeric field and entering the new setting.

NOTE: See Chapter 13, “Recommended Settings and Configurations” on page 201 for more information.

New, Load, Save, Save As..., Delete

Helps manage method creating, naming, saving, and editing.

NOTE: The active method cannot be loaded or edited on the Method Editor screen.

Print

Prints a method. This button is only available on the PC software.

Name

Displays the current method name. **Name** a method by pressing **New** or **Save As** and entering the name on the online alphabetic keyboard.



Copies a method from an Eclipse to the clipboard, simplifying copying methods from one Eclipse to another. This button is only available on the PC software. The copied method can also be pasted into other applications, such as a text document.



Pastes a previously copied method from one Eclipse to another. This button is only available on the PC software.

Trap

Displays the method's trap name. Change the trap by selecting a new trap from the dropdown. Press **View Trap Details...** to display the trap's settings and parameters.

NOTE: When selecting a trap, the desorb preheat temperature field automatically fills with the recommended setting.

NOTE: Edit trap parameters in the Trap Configuration screen (see "Trap Configuration Screen" on page 74 in this chapter).

Record Sample pH

Enables pH measurement with the *pHDetect* module.

NOTE: The Enable pH Sensor checkbox in the Options Configure screen must also be selected (see Chapter 7, "Installation" on page 139).

Sample Temp (°C)

Sets the **Sparge Mount** and **Sample** temperatures. Enter the desired temperature set points for these zones. The sparge mount and sample temperature range from 1 °C to 200 °C.

Purge Times and Temp

Enables these states and edits their set points: **Pre-Purge Time**, **Pre-Heat Time**, **Purge Time**, **Dry Purge Time**; and enables measuring and edits **Trap Temp (°C)** set point. The time ranges from 0.00 to 999.99 minutes. The trap temperature range varies with the trap type.

Water Mgmt Temps (°C)

Enables water management heating. Enter the desired water management temperature set points during **Purge**, **Desorb**, and **Bake** states. The purge, desorb, and bake temperature ranges from 1 °C to 270 °C.

NOTE: For most applications set the water management's desorb temperature to "0" to ensure the maximum cooldown temperature. The temperature decreases to 1 °C above ambient and then continues with the cycle.

The following are standard parameters for water temperatures:

- 110 °C in purge
- 0 °C in desorb
- 240 °C in bake

Bake	Enables and sets the Bake Time and the Trap Temp (°C) set point during bake. The bake time ranges from 0.00 to 999.99 minute. The trap temperature range varies with the trap type.
Desorb	Enables and sets the Desorb Time and the Trap Temp (°C) set point during desorb. The desorb time ranges from 0.00 to 999.99 minute. The trap temperature range varies with the trap type.
Desorb Preheat	Enables trap heating before desorb. Enter the desired Trap Temp (°C) set point for desorb preheat. The recommended desorb preheat trap temperature is 10 °C less than the desorb temperature.

Sequence Editor Screen

Generate new or edit existing sequences with the Sequence Editor screen (Figure 4.14). Access the Sequence Editor screen by touching the **Sequence** tab from the **Editor** icon.

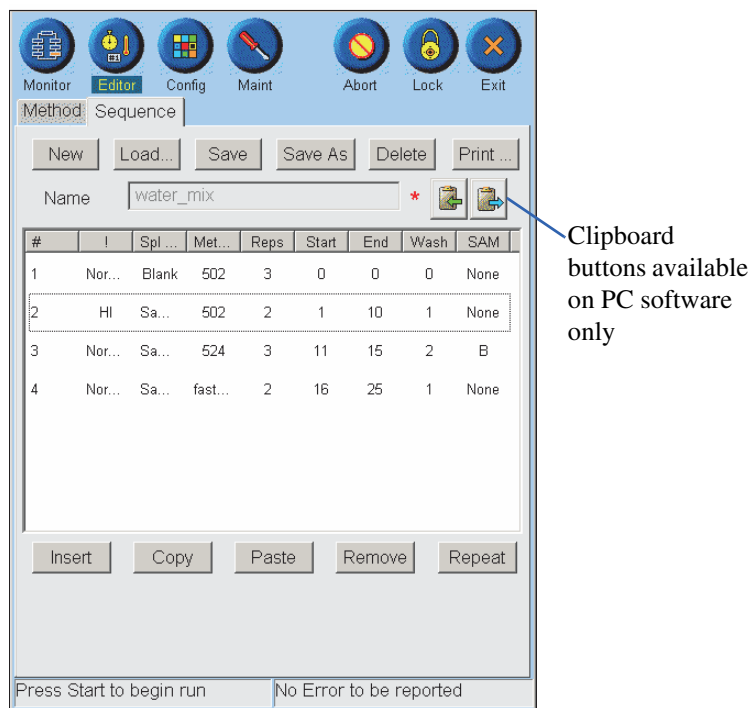



Figure 4.14. Sequence Editor screen

New, Load, Save, Save As..., Delete Helps manage sequence creating, naming, saving, and editing.

NOTE: The active sequence cannot be loaded or edited in the Sequence Editor screen.

Name	Displays the current sequence name. Name a new sequence by touching the field and entering the name on the online alphabetic keyboard.
	Copies a sequence from an Eclipse to the clipboard, simplifying copying sequences from one Eclipse to another. This button is only available on the PC software. Operators can also paste copied sequences into other applications, such as a text document.
	Pastes a previously copied sequence from one Eclipse to another. This button only appears on the PC software.
#	Displays the sequence line number.
!	Sets the priority of a sequence line: Normal or Hi .
Spl Type	Sets the analysis type to be performed: Sample or Blank .
Method	Sets the sequence line's method.
Reps	Sets the number of replicates per vial to be analyzed.
Start	Sets the starting autosampler vial position.
End	Sets the ending autosampler vial position.
Wash	Sets the number of washes or rinses per vial when using the Model 4551A Autosampler.
SAM	Enables the Standard Addition Module (SAM) (for the Model 4551A Autosampler only). <ul style="list-style-type: none"> • A indicates SAM A is active. • B indicates SAM B is active. • A/B indicates both SAM A and SAM B are active. • None indicates the SAM is not active.
Insert, Copy, Paste, Remove, and Repeat	Simplifies creating and editing sequences by easily adding and deleting sequence lines. <ul style="list-style-type: none"> • Insert adds a line at the bottom of the sequence if no line is selected, or adds a line below the selected line. • Copy duplicates a selected line to the clipboard. • Paste inserts the copied line from the clipboard at the bottom of the sequence or below the selected line. • Remove clears selected lines from the sequence. • Repeat duplicates the selected line and adds a line below. It copies and pastes all the information and increases the start position by one (Figure 4.12).

General Configuration Screen

The General configuration screen provides access to the instrument's basic system configurations and provides various functions to manage multiple instrument configurations (Figure 4.15). Access the General configuration screen by pressing the **General** tab from the **Config** icon.

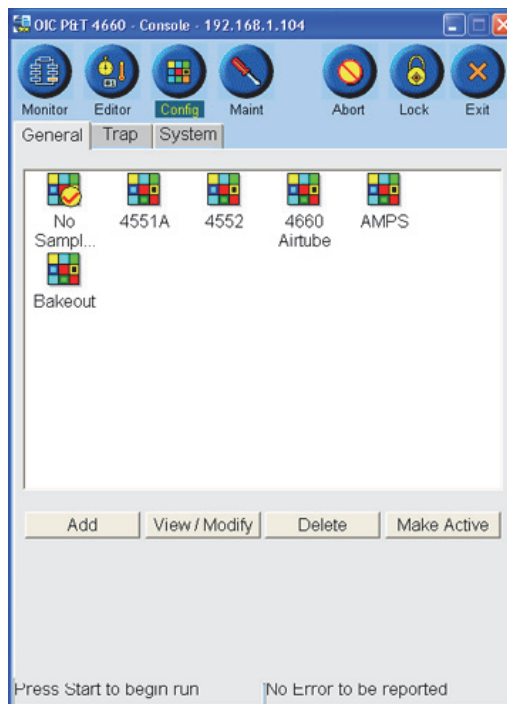

Figure 4.15. General configuration screen

- | | |
|--------------------|--|
| Add | Creates a new configuration. Press to access the Configure screen (see “Configure Screen” on page 64 in this chapter). |
| View/Modify | Accesses an existing configuration. Press to highlight its named icon and press View/Modify or double-click the file name. The Configure screen appears. |
| Delete | Deletes an existing configuration. Press to highlight its named icon and press Delete . |
| Make Active | Loads an existing configuration and makes it currently active. A check mark appears over the active configuration's icon. To make a configuration active, press to highlight its named icon and press Make Active . |

Configure Screen Set up new configurations or edit parameters with the Configure screen (Figure 4.16). Access the Configure screen from the General configuration screen by adding a new configuration or viewing or modifying an existing configuration.

Name Displays the current configuration name or enter the **Name** of a new configuration.

Save Saves any changes made.

Print Prints a configuration. This button is only available in the PC software.

Cancel Closes the Configure screen without saving any changes.



Copies a configuration from an Eclipse to the clipboard, simplifying copying configurations from one Eclipse to another. This button is only available on the PC software. Operators can also paste copied sequences into other applications, such as a text document.

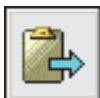

Pastes a previously copied configuration from one Eclipse to another. This button appears only on the PC software.

Basic tab Accesses the Basic Configure screen to set fundamental configuration parameters.

Advanced tab Accesses the Advanced Configure screen to set additional configuration parameters.

Autosampler tab Accesses the Autosampler Configure screen to set autosampler configuration parameters.

Options tab Accesses the Options Configure screen to set option configuration parameters such as the *pHDetect* module.

Basic Configure Screen

Set essential configuration parameters from the Basic Configure screen (Figure 4.16) such as choosing the autosampler, setting the autosampler sample size and operational parameters, and setting transfer line and valve oven temperatures.

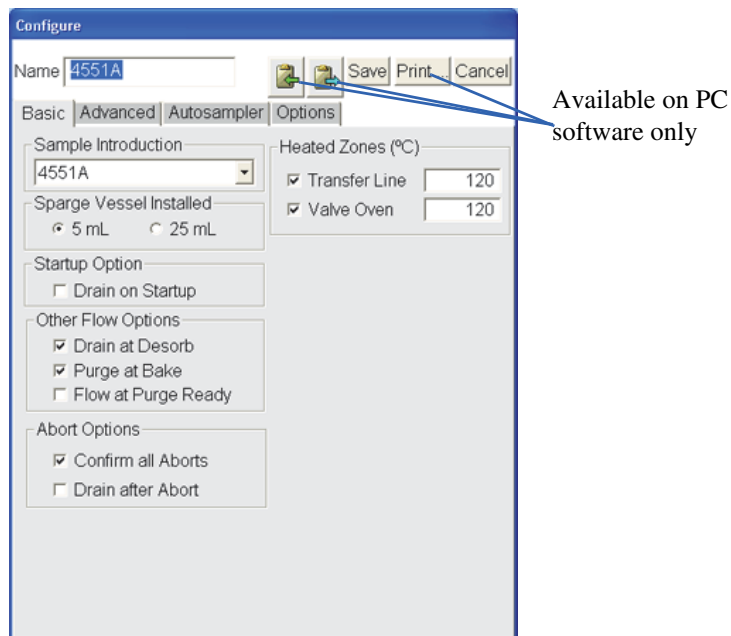

Figure 4.16. Basic Configure screen

Sample Introduction	Sets the sample introduction mode: Manual (No Sampler) , 4551A , 4552 , 4660 Airtube Option , or AMPS .
Sparge Vessel Installed	Selects the sparge vessel size: 5 mL or 25 mL .
Startup Option	Enables Drain on Startup , which helps prevent overfills by automatically draining the sparge vessel when the instrument powers up.
Other Flow Options	Enables the following flow options: <ul style="list-style-type: none"> • Drain at Desorb: the sample drains during desorb. • Purge at Bake: purge gas flows through the sparge vessel during bake. • Flow at Purge Ready: gas flows through the sample pathway and sparger during purge ready. If not selected, flow does not occur during purge ready, but the system remains slightly pressurized during this state and is protected by a check valve at the purge vent.

Abort Options

Enables the following abort options:

- **Confirm all Aborts:** the abort action must be confirmed before continuing.
- **Drain after Abort:** the sample drains as part of the Abort function.

Heated Zones (°C)

Enables heating and sets the temperatures of the **Transfer Line** and the **Valve Oven**. The temperature ranges from 1 °C to 325 °C for the transfer line and 1 °C to 350 °C for the valve oven. The default temperature for both the transfer line and valve oven is 110 °C.

Advanced Configure Screen

Set additional configuration parameters from the Advanced Configure screen.

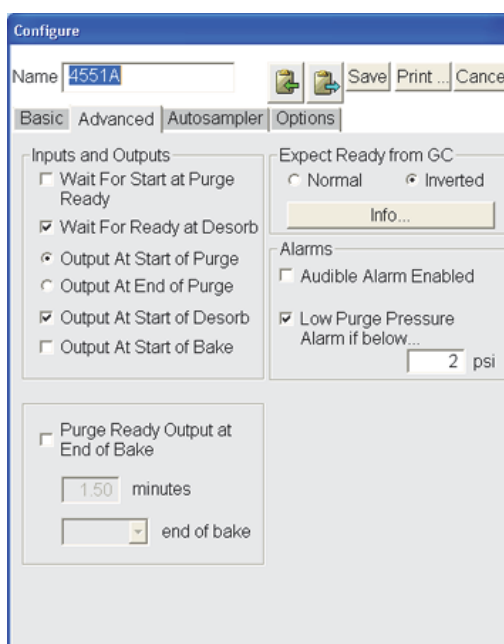

Figure 4.17. Advanced Configure screen

Inputs and Outputs

Enables the following inputs and outputs:

NOTE: The selected autosampler's default settings are automatically entered for these parameters. Overwrite the settings if required.

- **Wait for Start at Purge Ready:** the Eclipse waits at purge ready after each cycle for an external start signal. Choose this option when an external device, such as the Model 4552 Autosampler, AMPS, or PT Express™ Dual Purge-and-Trap Interface, starts the Eclipse.
- **Wait for Ready at Desorb:** the Eclipse waits at desorb ready until the GC sends the proper ready signal. Choose this option for all GC analyses. Disable this option when using the Eclipse without the GC, such as conditioning a trap or cycling the instrument for cleaning.
- **Output at Start of Purge:** Not used.
- **Output at End of Purge:** Not used.
- **Output at Start of Desorb:** the Eclipse sends a contact closure output at the beginning of desorb. This output typically starts the GC when desorb begins. Choose this option for all GC analyses.
- **Output at Start of Bake:** the Eclipse sends a contact closure output at the beginning of bake. Refer to the autosampler's manual if requiring Output at Start of Bake.

CAUTION:

*Enabling **Purge Ready Output at End of Bake** incorrectly may result in loss of sample. If sending the purge ready output signal too early, the Model 4552 in water mode transfers the sample to the Eclipse while it is still in bake or standby. The Eclipse waits for the trap temperature to cool, causing analytes to escape out the bake vent. Likewise, the Model 4552 in soil mode starts purging the sample while the Eclipse is still in bake or standby.*

Purge Ready Output at End of Bake

Allows the Eclipse to turn on the purge ready output before the instrument goes to purge ready. Use this function to start the Model 4552 Autosampler before the purge ready state to shorten overall cycle time. For example, the Model 4552 running in water mode with a 25-mL sample takes approximately 3½ minutes to prepare to transfer the sample to the Eclipse. If sending the purge ready output early, the autosampler starts preparing to transfer the sample before the Eclipse completes its cycle. See Figure 4.18.

Set the end of bake to **Before**, **At**, or **After**. Enter minutes between 0.00 and 20.00.

- **Before:** the Eclipse sends the purge ready output before completing bake. For example, a setting of 0.5 minutes sends the purge ready output 30 seconds before bake completes.
- **At:** the Eclipse sends the purge ready output at the end of bake. When choosing **At**, the minutes field becomes inactive and is automatically set to 0.
- **After:** the Eclipse sends the purge ready output x.xx minutes after completing bake or at purge ready, whichever comes first.

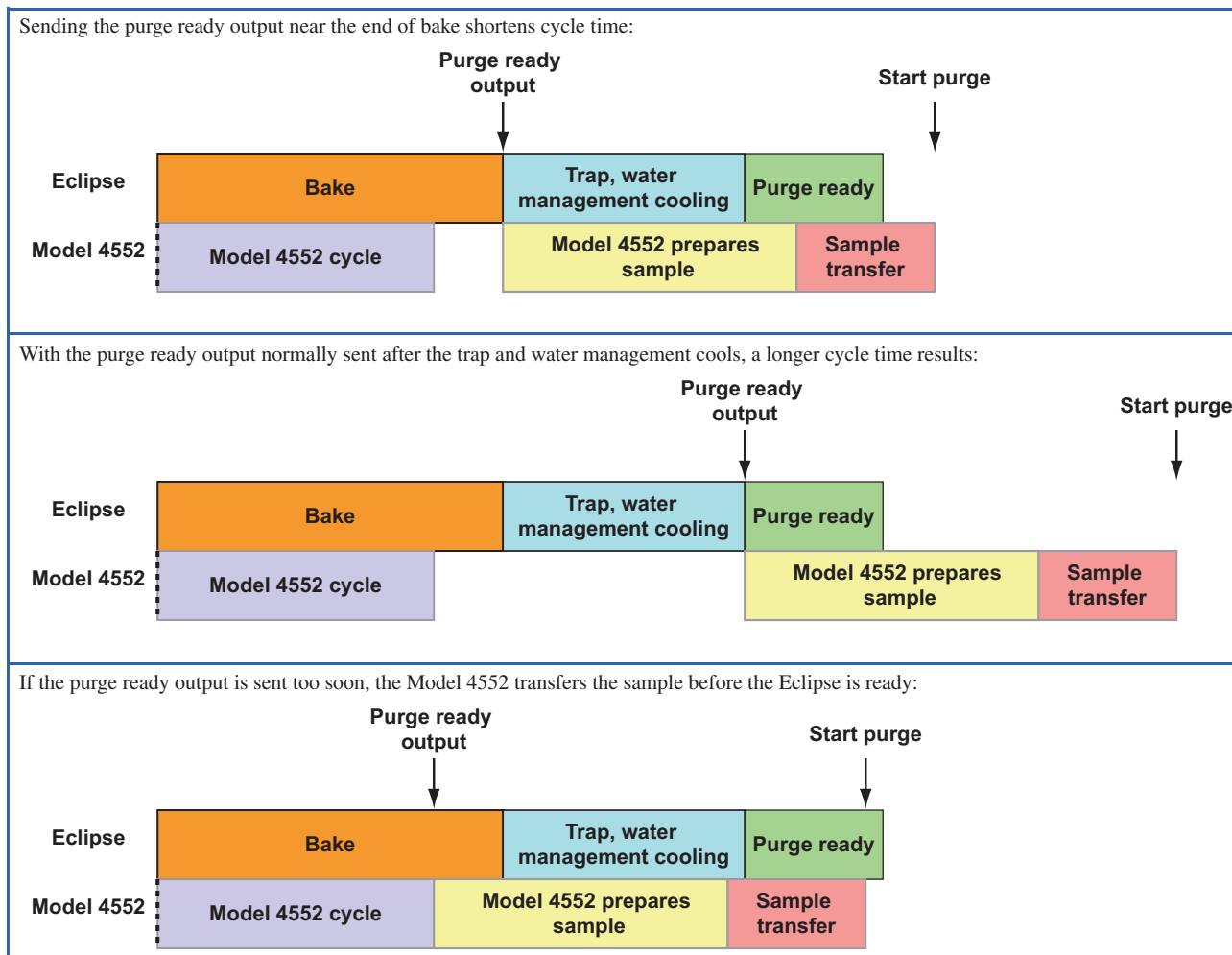

Figure 4.18. Setting the Purge Ready Output at End of Bake option

Expect Ready from GC

Tells the Eclipse what type of signal to expect from the GC when the GC is ready. Choose **Normal** (active low) or **Inverted (active high)**. Press **Info** for information on which signal to select for commonly used GCs. The GC Expect Ready Information popup appears.

NOTE: If a particular GC is not listed, select **Normal** since this is the most common signal.

Alarms

Enables audible alarms to sound when choosing **Audible Alarm Enabled**. When an error occurs, an alarm sounds on the Eclipse, and also on the PC running the Eclipse software and connected to the Eclipse.

Low Purge Pressure Alarm... applies to prepurge and purge states only. With this option selected, the Eclipse monitors the pressure after two minutes elapses in either of these states. If the pressure falls below or never reaches the specified psi value, an error message appears on the screen and becomes written in the run log. An audible alarm sounds if audible alarms are enabled. This error does not stop the cycle. Set the minimum acceptable **psi** value, ranging from 0 to 10 psi.

Autosampler Configure Screen

Set the Model 4551A Autosampler configuration parameters with the Autosampler Configure screen (Figure 4.19).

The screenshot shows the 'Configure' dialog box for the Model 4551A Autosampler. The 'Name' field is set to '4551A'. The 'Autosampler' tab is selected, showing the following configuration options:

- Installed 4551A Loop:** Radio buttons for '5 mL' (selected) and '25 mL'.
- 4551A Needle Depth (pct):** A text box containing '94'.
- Sample Vials:** A text box containing '94'.
- Wash Vials:** A text box containing '98'.
- 4551A Needle Calibration:** A text box containing '3950'.
- 4551A Loop Fill and Transfer:** A table of timing parameters:

Loop Size	Fill Time	Transfer Time
5 mL ...	0.15	0.40
Wash ...	0.23	0.50
25 mL ...	0.40	0.75

Figure 4.19. Autosampler Configure screen

NOTE: The configuration parameters are only available when the Model 4551A is selected as the sample introduction mode.

NOTE: Program the Model 4552 from the Model 4552 Autosampler's front panel.

Installed 4551A Loop	Selects the loop size installed on the autosampler: 5 mL or 25 mL . If the selected loop size does not match the sample size selected the Basic Configure screen, a warning message appears.
4551A Needle Depth (pct)	Sets the depth (percent) that the needle penetrates the Sample Vials and the Wash Vials .
4551A Needle Calibration	Sets the physical depth that the needle travels when set to 100%. It ranges from 0 to 4,000. The typical setting is 3,950.
4551A Loop Fill and Transfer	Sets the fill times (minutes) and transfer times (minutes) for the 5 mL and 25 mL sample loops. Also set the fill time and empty time for the Wash vial. They range from 0.00 to N.A. The defaults times are as follows:

Table 4.2. Model 4551A sample loop and wash vial times

Parameter	Fill Time (minutes)	Transfer Time (minutes)	Empty Time (minutes)
5-mL sample loop	0.15	0.40	—
25-mL sample loop	0.40	0.75	—
Wash vial	0.23	—	0.50

Options Configure Screen

Configure option parameters from the Options Configure screen (Figure 4.20).

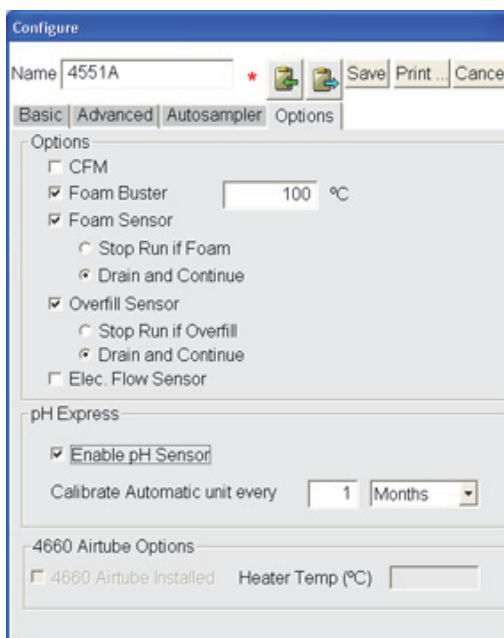

Figure 4.20. Options Configure screen

CFM

This option is not used.

Foam Buster

Enables the Foam Buster Option and sets the Foam Buster Option temperature set point. The default temperature setting is 125 °C.

NOTE: Set the sparge mount temperature to 50 °C or higher when running the Foam Buster heater. Failure to do so can result in the instrument not reaching purge ready.

Foam Sensor

Enables the Foam Sensor option. The Foam Sensor monitors for foam during sample transfer (from the Model 4551A Autosampler), prepurge, and purge. Choose between the following options:

- **Stop Run if Foam:** immediately drains the sparge vessel and halts the run or sequence. An error message is written in the run log. A message appears in the status bar that the run has stopped. The Eclipse remains in this state until the user intervenes.
- **Drain and Continue:** immediately drains the current sample if foam is detected to avoid system damage. The Eclipse advances to desorb and triggers the GC to start a run, allowing the data handling system to account for the foaming sample so samples do not get out of sequence. An error message is written in the run log. The Eclipse then continues with the next sample if the condition clears.

NOTE: All Foam Sensor events become logged in the Eclipse's run history.

Overfill Sensor

Enables the Overfill Sensor option. The SOS™ prevents filling the sparge vessel with the next sample if the previous sample is not properly drained for any reason. The capacitance-type sensor operates by monitoring for liquid in the sparge vessel after bake, just prior to sample transfer (at standby for the Model 4552 and at loop fill for the Model 4551A). If detecting liquid, one of the following options occurs, depending on which is enabled:

- **Stop Run if Overfill:** immediately drains the sparge vessel and halts the run or sequence. An error message is written in the run log. A message appears in the status bar that the run has stopped.
- **Drain and Continue:** drains the current sample and continues with the sequence.

NOTE: When Drain and Continue is enabled, the Eclipse continues to attempt draining the system until the sensor no longer detects liquid in the sparge vessel.

NOTE: All SOS™ events become logged in the Eclipse's run history.

Elec. Flow Sensor

This option is reserved for future use.

Enable pH Sensor

Enables the pH Sensor and sets the calibration frequency in hours, days, or weeks. Please refer to Chapter 7, "Installation" on page 139 for more information.

4660 Airtube Option Enables the Air-Tube option and sets the heater temperature (°C). Access this field only when **4660 Airtube option** is selected as the sample introduction mode. The Air-Tube heats to the specified heater temperature during purge preheat and purge.

Trap Configuration Screen

The Trap configuration screen provides access to trap configurations (Figure 4.21). Access the Trap configuration screen pressing the **Trap** tab from the **Config** icon. The Method Editor and the Active Method screens use these settings.

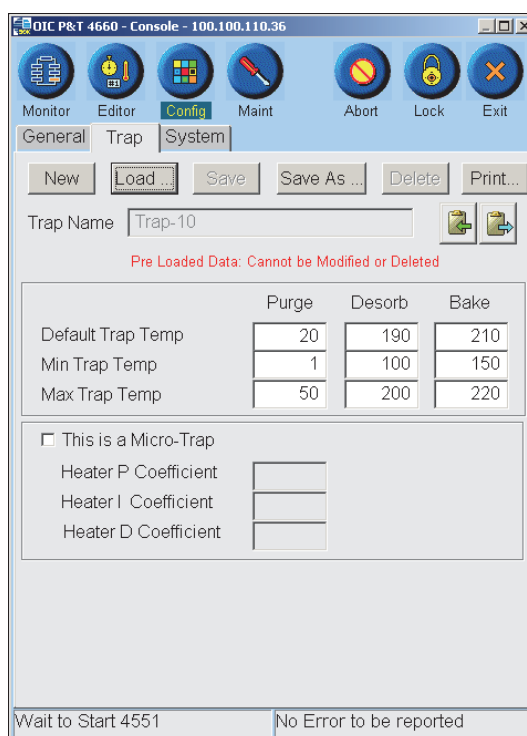

Figure 4.21. Trap configuration screen

New, Load, Save, Save As..., Delete

Helps manage trap configuration creating, naming, saving, and editing.

Trap Name

Displays the current trap name. Enter the **Trap Name** of a custom trap configuration in this field.

NOTE: The Eclipse contains standard trap configurations that are already defined and cannot be deleted. The Default Trap Temp of these configurations can be modified, but Min Trap Temp and Max Trap Temp cannot be changed. To change these parameters, define a custom trap configuration.

Default Trap Temp	Displays the default trap temperatures during Purge , Desorb , and Bake . Default temperatures are already defined for most common traps. Define custom trap settings by entering the information in the appropriate fields.
Min Trap Temp	Displays the minimum trap temperatures during Purge , Desorb , and Bake . Default temperatures are already defined for most common traps and cannot be modified. Define custom trap settings by entering the information in the appropriate fields.
Max Trap Temp	Displays the maximum trap temperatures during Purge , Desorb , and Bake . Default temperatures are already defined for most common traps and cannot be modified. Define custom trap settings by entering the information in the appropriate fields.
This is a Micro-Trap	The Micro-Trap has been discontinued. This function is not available.

System Configuration Screen

Set system configuration parameters with the System configuration screen (Figure 4.22) Access the System configuration screen by pressing the **System** tab from the **Config** icon.

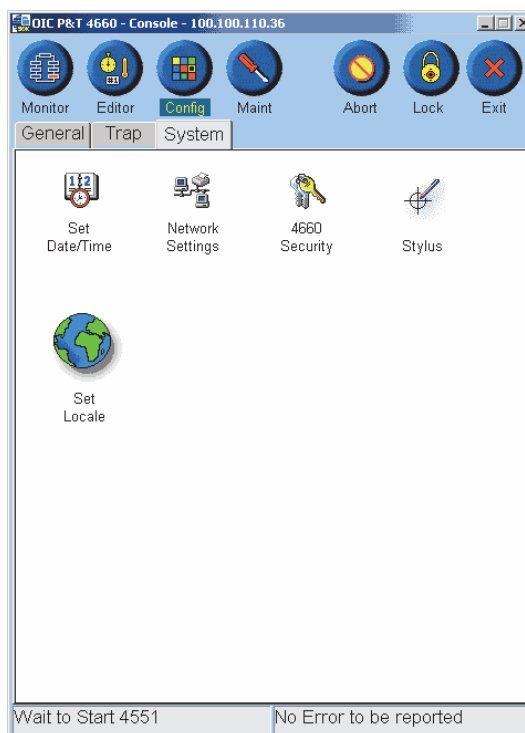

Figure 4.22. System configuration screen

Set Date/Time

Accesses the Eclipse Date/Time Properties dialog box remotely from the PC connected to the Eclipse (Figure 4.23) or locally from the instrument to set the correct date and local time.

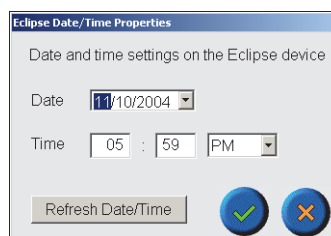

Figure 4.23. Date/Time Properties dialog box accessed remotely from the Eclipse PC

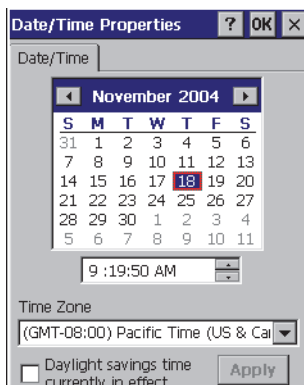

Figure 4.24. Date/Time Properties dialog box accessed locally from the Eclipse touchscreen

NOTE: Do not use the Time Zone or Daylight savings time options. Set the date and time only from the Date/Time Properties dialog box.

Network Settings

Accesses the Network Settings dialog box to set network parameters. For more information, see Chapter 14, “Modifying Eclipse Network Settings” on page 218.

4660 Security

Accesses the **Eclipse 4660 Security Login** dialog box to set up new Eclipse users or modify permissions. For more information, see Chapter 3, “Setting Up a New User ID” on page 24.

Stylus

Calibrates the touchscreen. This option is only available on the touchscreen.

Locale

Accesses the Set Locale dialog box (Figure 4.25). Choose the desired language on the Eclipse, then power the instrument off and on enable the selection.

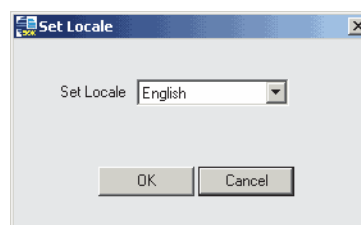

Figure 4.25. Set Locale dialog box

Configure a Windows XP Computer for Chinese

To use the language support on the Eclipse PC software, the PC must be properly configured for the appropriate language. For example, if configuring the Eclipse for Chinese, the PC running the Eclipse software must also be configured for Chinese.

Configure a Windows XP PC for Chinese using the following instructions:

1. Save all files and close any open applications on the PC.
2. Open the Windows Control Panel. Double-click the **Regional and Language Options** icon to open the Regional and Language Options dialog box (Figure 4.26).

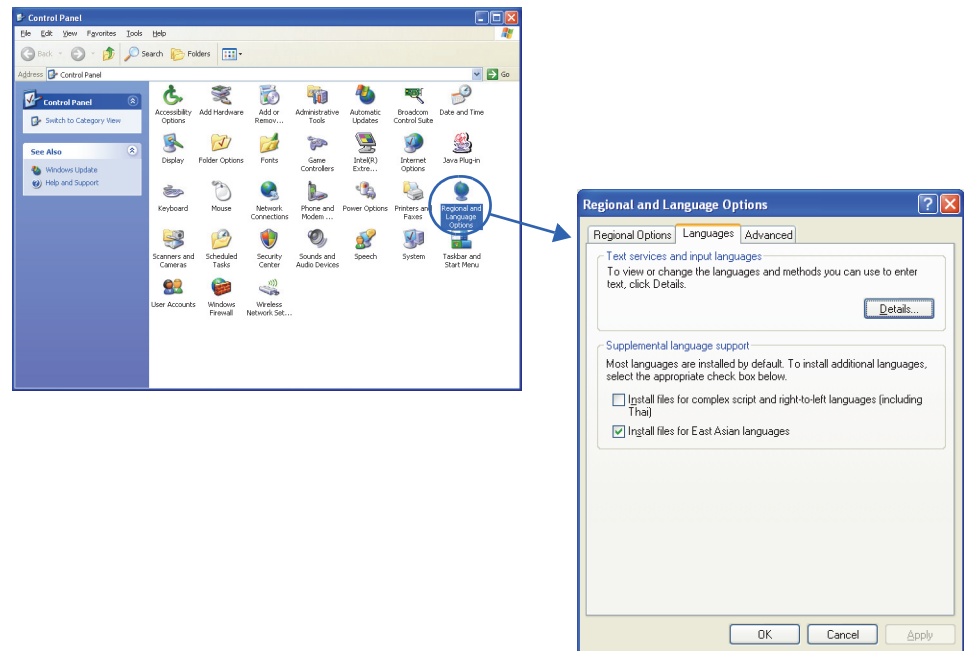

Figure 4.26. Opening the Regional and Language Options dialog box

3. Click the **Language** tab. Select **Install files for East Asian languages** if these files are not already installed (Figure 4.26).
4. Click the **Advanced** tab (Figure 4.27). Select the language “Chinese (PRC).” Click **OK**. The systems prompts to restart the computer.

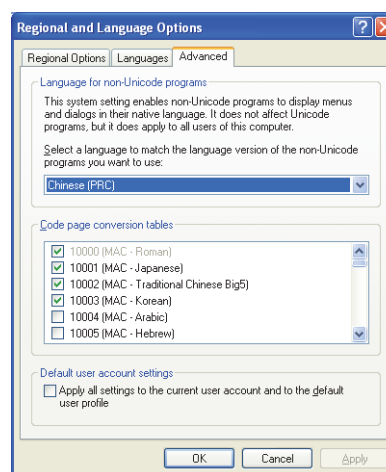

Figure 4.27. Advanced Regional and Language Options dialog box

5. Open the Eclipse 4660 LaunchPad and log into the Eclipse. If Chinese PRC was selected in step 4, the login dialog box should appear with Chinese text.

The message shown in Figure 4.28 may appear, indicating the locale settings for the PC and the Eclipse unit do not match.

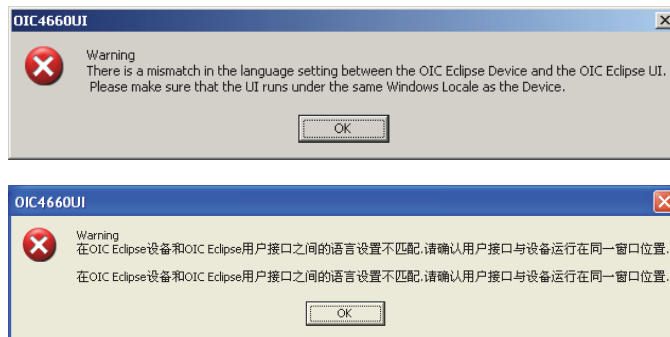

Figure 4.28. Locale setting mismatch error message

If the PC is set to run a language not supported by the Eclipse, the following message appears (Figure 4.29). Click **OK** to dismiss the warning and continue running the Eclipse in English.

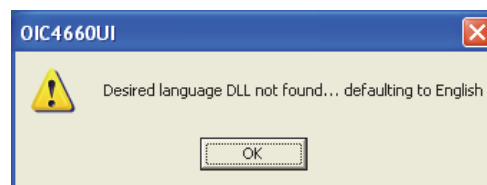

Figure 4.29. Language not available error message

Maintenance Screen

The Maintenance Screen contains icons that access maintenance and service functions (Figure 4.30). For complete information about each option, see Chapter 6, “Maintenance” on page 101.

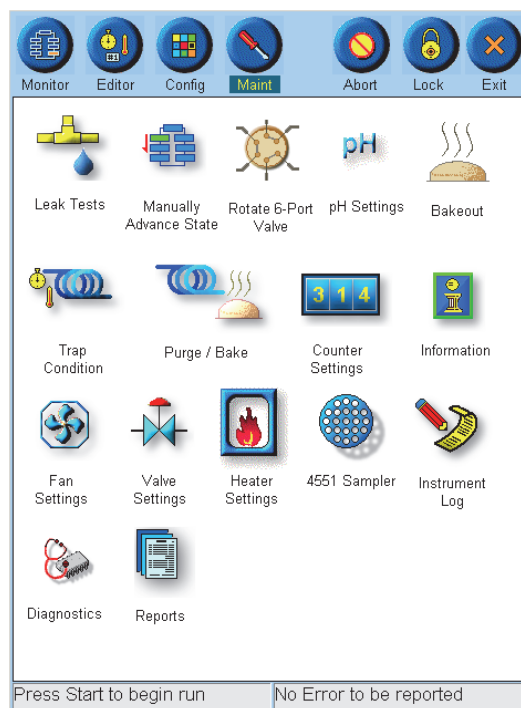

Figure 4.30. Maintenance screen

NOTE: Some of the functions cannot be accessed during a run such as Leak Test, Manually Advance State, and Rotate 6-Port Valve.

Leak Test

Accesses the Maintenance: Leak Tests dialog box to initiate an automated leak test. Choose from the following test options:

- **Full:** performs a complete system leak test both through the sparger and bypassing the sparger.
- **Through Sparger:** performs a leak test with the dry purge valve in the normally open position (purge path). See Figure 18.19., “Leak test A (wet system)” on page 282 and Figure 18.20., “Leak test B (wet system)” on page 283.
- **Bypass Sparger:** performs a leak test with the dry purge valve in the normally closed position (dry purge path). See Figure 18.17., “Leak test A (dry system)” on page 280 and Figure 18.18., “Leak test B (dry system)” on page 281.

Manually Advance State	Accesses the Maintenance: Change State dialog box to manually change the instrument state and to access flow diagrams associated with each state.
Rotate 6-Port Valve	Accesses the Maintenance: Rotate 6-Port Valve dialog box to manually rotate the valve.
pH Settings	Accesses the Maintenance: pH Settings dialog box to monitor pH <i>Detect</i> module operations and enable the following options: Measure pH ; Calibrate pH ; Load pH Buffer , and Drain .
Bakeout	Runs the bakeout method for the set number of cycles. Use bakeout to cycle the Eclipse repeatedly at elevated temperatures to clean the instrument. Press to access the Maintenance: Bakeout dialog box and enter the number of bakeout cycles. The bakeout method overrides the active configuration and uses the following setting: Manual (No Sampler) ; Drain at Desorb disabled; Wait for Start at Purge Ready disabled. Change the bakeout method's default times and temperatures using the Method Editor screen.
Trap Condition	Use to condition a trap. Press to access the Maintenance: Trap Condition dialog box. The bake time and temperature autofill from the parameters entered in the active method. If desired, change the Time (min) and Trap Temp (°C) . The Time ranges from 0.00 to 999.99 minutes. The Trap Temp range depends on the trap type.
Purge/Bake	Cycles the Eclipse through purge and bake <i>only</i> for a set number of cycles and provides an alternate way to condition a trap. Purge/Bake uses the active method's times and temperatures. Press to access the Maintenance: Purge/Bake dialog box and enter the Number of Cycles .
Counter Settings	Accesses the Maintenance: Counter Settings dialog box to view the instrument cycle counters. The instrument cycle counters can also be reset from this dialog box.
Information	Accesses the Maintenance: Information popup to view instrument and system information such as the version and serial number. Change serial numbers to reflect component replacement or service.
Fan Settings	This option is reserved for future use.
Valve Settings	Accesses the Maintenance: Valve Settings dialog box to manually actuate the following valves: Backflush (C) ; Bakeout (A) ; Bypass (B) ; Drain (D) ; Purge Gas (F) .

Heater Settings	Accesses the Maintenance: Heater dialog box to enable and disable heating of the following areas: Trap; Sparge Mount; Valve Oven; Water Mgmt; Transfer Line; Foam Buster; Spare; Sample . Enable these areas for the Eclipse to heat the particular zone.
4551 Sampler	Accesses the Maintenance: 4551 Sampler dialog box to manually perform the following autosampler functions: Advance to Vial Position; Transfer; Fill; Raise Needle; T-Valve; and Wash .
Instrument Log	Accesses the Maintenance: Instrument Log dialog box. See Chapter 6, “Instrument Log” on page 112 for more information.
Diagnostics	Accesses the Diagnostics dialog box. See Chapter 6, “Diagnostics” on page 116 for more information.
Reports	Opens the Reports screen to generate instrument maintenance reports. This option is only available on the PC software. See Chapter 6, “Reports” on page 119 for more information.



Chapter 5 Operation

This chapter provides operating information for the Eclipse.

Instrument States

The Eclipse strips purgeable organic compounds from an aqueous sample, concentrates them on a specified sequence of adsorbent materials, and rapidly desorbs them using heat and carrier gas flow onto a GC column. The Eclipse is one component of a purge-and-trap analytical system. Other necessary components include a GC, single or multiple detectors, and a data-handling device for quantifying detector signals. An autosampler for introducing samples to the concentrator can also be part of the overall analytical system.

The Eclipse uses 11 primary purge-and-trap states. A state is a set of valve and trap temperature combinations defined for purge-and-trap analyses:

- Standby
- Purge ready
- Prepurge
- Preheat
- Purge (adsorb)
- Dry purge
- Purge complete
- Desorb ready
- Desorb preheat
- Desorb (with or without drain)
- Backflush bake (with or without purge)

The Eclipse runs through specific sequences of states as defined in the method. Various analytical procedures for purgeable organics require different times and temperatures for these states. Program the Eclipse with up to 500 operator-defined parameters or methods.

State Sequencing

When the Eclipse runs, the microprocessor automatically advances the system through the following sequence of primary states, each existing for the time specified by the method, or for some states, until meeting some other condition.

Standby

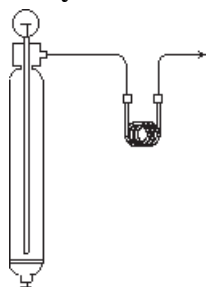

The Eclipse remains in this pass-through state until attaining all temperature set points. When all heated zones are ready and the trap cools to the purge temperature set point, the Eclipse advances to purge ready. Standby is one of several states not indicated on the cycle state indicator on the Status screen and is only seen on the status bar since no parameter entry is possible.

Purge Ready

The Eclipse enters this state when all conditions are met to start the next analysis. The instrument sits at purge ready until a run initiates either by the operator or by an external device. The Eclipse can be configured to stop at purge ready after each sample run, waiting for the next sample and start command to be received.

Prepurge

The Eclipse normally uses this optional state only for air analysis. Prepurging an air tube removes oxygen and excess moisture accumulated in the tube during sample collection. Prepurging a hydrophobic substrate (e.g., Tenax[®]) reduces the moisture transferred to the trap.

Preheat

This state prior to purge allows a heated sample (e.g., air tube, soil, or water) to equilibrate to a preset temperature before purge begins. The Eclipse only uses this state when a sample heater or air-tube heater is present and sample heating is desired.

Purge (Adsorb)

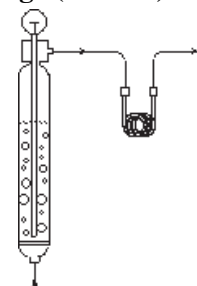

Sample extraction occurs during this state. Inert gas passes through the sample for a specified time and temperature, and volatiles adsorb onto the Eclipse's trap for subsequent desorption to the GC column.

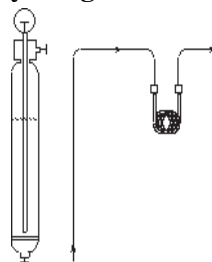
Dry Purge

This optional state removes moisture from the hydrophobic substrates in the trap. During dry purge, the sample is bypassed and the trap purges with dry purge gas directly. Dry purge is usually not necessary with the Eclipse, which has an effective water management system.

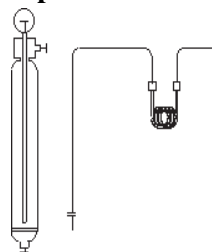
Purge End or Complete

This pass-through state indicates the purge state completed. If the water management system is not ready, the Eclipse remains in purge end or complete until the Cyclone Water Management™ system reaches the required set point for desorption.

Desorb Ready

After completing all purging and the water management reaches its set point, the Eclipse advances to desorb ready. While in desorb ready, the Eclipse checks for ready signals from other components of the system (e.g., GC) before advancing to desorb.

Desorb Preheat

When desorb preheat is enabled, the Eclipse heats the trap to a desorb preheat set point without carrier gas flow (e.g., prior to valve rotation). Use this technique to achieve narrow desorption bandwidth when trap heating (analyte release) from the trap is slow. Desorb preheat is usually not necessary due to the Eclipse's direct resistance heating.

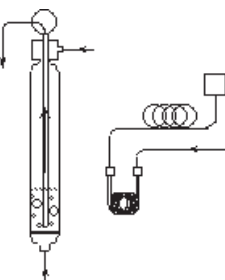
Desorb

During desorb, the Eclipse's trap heats rapidly to the set temperature, transferring volatile compounds through the Eclipse heated transfer line to the GC injector port. If using a needle sparger (draining is not possible), disable **Drain at Desorb** to configure the Eclipse not to drain (see Chapter 4, "Basic Configure Screen" on page 65). Otherwise, an aqueous sample automatically drains during desorb (enable **Drain at Desorb**).

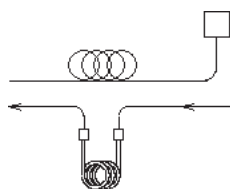
Backflush Bake

This cleanup state backflushes the trap under heat and reverse flow to remove and vent any components not transferred to the GC column. Choose whether to purge or not purge the sample during bake (see Chapter 4, "Basic Configure Screen" on page 65).

NOTE: Other Autosampler-specific states exist. Refer to the appropriate Autosampler operator’s manual for descriptions of any states not listed.

Cycle State Indicator

The cycle state indicator (Figure 5.1) on the Status screen displays instrument activity. Use the following guidelines for reading the cycle state indicator.

- Blue color indicates the state has been activated during a run.
- Grey color indicates the state is not activated.
- Green color indicates the current state. The bar below the cycle state indicator also shows the current state. If the run pauses, the current state bar shows “XXX—Paused,” where XXX is the current state.
- Standby, a state not shown on the cycle state indicator, occurs between bake and purge ready. The trap and water management temperatures equilibrate to the purge temperature set point during standby.
- Purge end or complete occurs between purge and desorb ready or dry purge and desorb ready if a dry purge time is entered. The water management system may be cooling before desorb during this state.

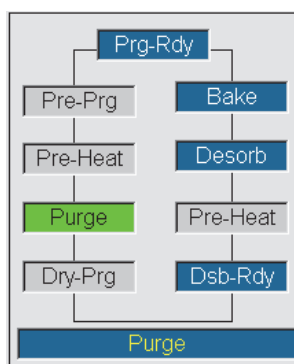



Figure 5.1. Cycle state indicator

Operational Overview

The following provides an overview of Eclipse operation. Using autosamplers and options may add additional steps. Detailed instructions follow in the next sections.

1. Turn on the Eclipse, if necessary. Log in by entering the **User ID** and **Password**.
2. Adjust gas pressures, if necessary (see Chapter 3, “Setting the Purge Gas Pressure and Flow Rate” on page 40). Perform all necessary functional checks.
3. Configure the Eclipse.
4. If using the Model 4551A Autosampler, choose an existing sequence or create a new one.

5. Choose an existing method (e.g., Method 1, USEPA 502.2/524.2) or create a new method.
6. Load samples.
7. Press the **Start** icon  to begin the run or allow the external device such as the Model 4552 Autosampler or AMPS to start the run.

Logging In

1. Turn on the power switch located on the Eclipse back.
2. The Eclipse Login dialog box appears. Press **User ID** and enter the user identification using the onscreen keyboard. Press **OK** to save the changes or **Cancel** to exit the screen without saving the changes. For more information, see Chapter 3, “Starting the Eclipse” on page 24.

NOTE: The factory-set default User ID and Password are “4660”.

3. Press **Password** and enter the user password using the onscreen keyboard. Press **OK** to save the changes or **Cancel** to exit the screen without saving the changes.
4. Press **OK** again to enter the program.

Using Configurations

Configuring the Eclipse

Configure the Eclipse and associated autosamplers and options before beginning a run.

1. Press the **Config** icon to access the General configuration screen (Figure 5.2).

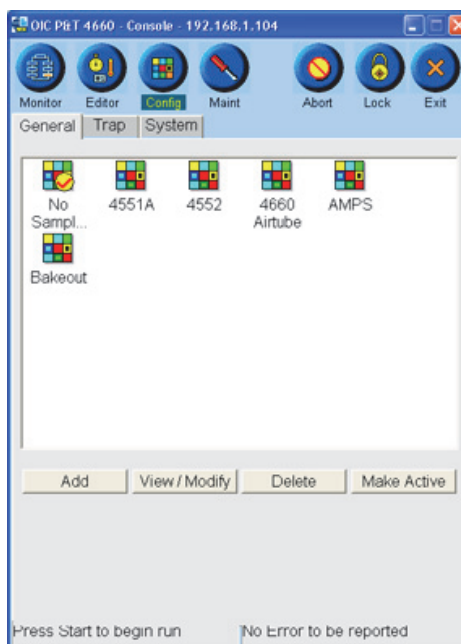

Figure 5.2. General configuration screen

2. Select an existing configuration by pressing and highlighting its named icon and pressing **View/Modify**, or create a new configuration by pressing **Add**.
 - The General configuration screen contains preset configurations (Table 5.1).

Table 5.1. Preset configurations

Configuration Name	Default Settings
No Sampler	Manual sample introduction
4551A	Model 4551A Autosampler
4552	Model 4552 Autosampler
Airtube	Single air-tube option
AMPS	Model 4506 Automated Multipoint Process Sampler (AMPS)
Bakeout	Manual (no sampler)

3. From the Configure screens, select or enter parameters for specific instrument configurations. See Chapter 4, “General Configuration Screen” on page 63 for more information. Press **Save** to save the changes or **Cancel** to exit the screen without saving the changes.
4. To designate the active configuration, press and highlight the named icon and press **Make Active**. A check mark appears above the active configuration’s named icon.

Working with Configurations

If using **4551A** for Sample Introduction, the active method becomes inaccessible, since the sequence controls which method is active. To make changes to a method, use the Method Editor. If the method to be edited is currently the active method, clear the sequence, then load the method into the Method Editor.

NOTE: Sequences only apply to the 4551A sample introduction mode.

If using any sample introduction configuration except 4551A, changes to the active method can be made and applied during a run.

Using Sequences

The Eclipse uses sequences to automate sample runs when working with the Model 4551A Autosampler. Create, view, and edit sequences from the Sequence Editor screen. Make a sequence active from the Active Sequence screen.

Using the Sequence Editor

Generate new or edit existing sequences from the Sequence Editor screen. (Figure 5.3).

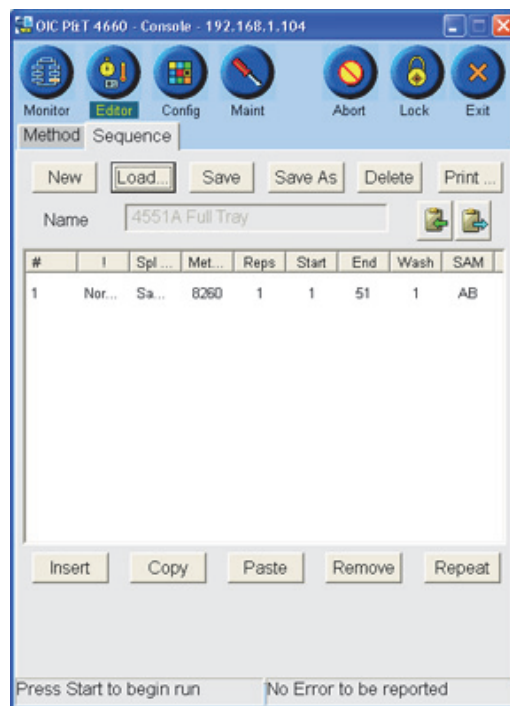

Figure 5.3. Sequence Editor screen

1. Access the Sequence Editor screen by pressing the **Editor** icon; press the **Sequence** tab.
2. Press **New** to create a new sequence or press **Load** to access an existing sequence.

NOTE: An active sequence cannot be loaded from this screen. View an active sequence from the Active Sequence screen. See “Working with Active Sequences” on page 90 in this chapter for more information.

- If pressing **New**, the Sequence Name dialog box appears. Enter the new sequence name using the onscreen keyboard. Press **OK** to save the changes or **Cancel** to exit the screen without saving the changes.
 - If pressing **Load**, the Load Sequence dialog box appears. Select an existing sequence from the dropbox. Press **OK** to save the changes or **Cancel** to exit the screen without saving the changes.
3. To insert a line above an existing line, press to highlight that line. Press **Insert**. Press to highlight the new line to begin editing.

To add a line at the end of the sequence, press the blank area of the sequence table (no line is highlighted). Press **Insert**. Press to highlight the new line to begin editing.

Repeat duplicates the selected line and adds a line below. It copies and pastes all the information and increases the start position by one. See Chapter 4, “Sequence Editor Screen” on page 61 for more information.

4. Select or enter specific parameters for the sequence. See Chapter 4, “Sequence Editor Screen” on page 61 for more information.

NOTE: The autosampler vials cannot be run in a nonsequential manner. The ending autosampler vial position cannot be set for a location before the starting vial position. To skip vials, insert a new line and set the starting vial position for the next desired sample.

NOTE: Use Insert, Copy, Paste, Remove, and Repeat to simplify sequence creation and editing. Paste inserts below a highlighted line.

5. Press **Save** to save the changes, **Save As** to save the sequence with a new name, or **Cancel** to exit the screen without saving the changes.

Working with Active Sequences

An active sequence is the currently loaded sequence. When the run commences, the samples run in the order and using the method specified in the active sequence. Once the run starts, only lines that have not run can be edited. Make a sequence active from the Active Sequence screen.

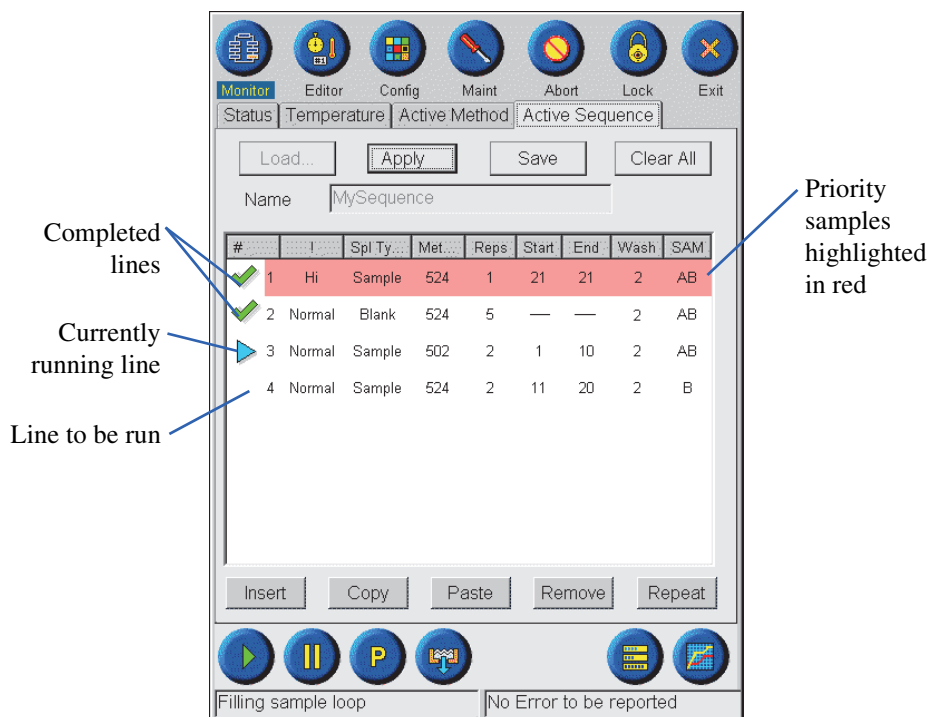

Figure 5.4. Active Sequence screen

1. Access the Active Sequence screen by pressing the **Monitor** icon. Press the **Active Sequence** tab.
2. Press **Load** to make a sequence active. The Load Sequence dialog box appears. Select a sequence from the dropdown. Press ?to save the changes or ?to exit the screen without saving the changes.
3. To edit the active sequence, press to highlight the line. Select and enter any parameter changes. See Chapter 4, “Active Sequence Screen” on page 56 for more information.

NOTE: The autosampler vials cannot run in a nonsequential manner. Do not set the ending autosampler vial position to a location before the starting vial position. To skip vials, **Insert** a new line and set the starting vial position for the next desired sample.

NOTE: Use Insert, Copy, Paste, Remove, and Repeat to simplify sequence creation and editing. See “Using the Sequence Editor” on page 89 in this chapter.

4. Press **Apply** to apply the changes to the active sequence only. The changes are *not* saved to the sequence file.
5. Press **Save** to save the changes to the sequence file, **Save As** to save the sequence with a new name, or **Cancel** to exit the screen without saving the changes.

NOTE: Changes made to the active sequence using **Apply** or **Save** become logged as sequence changes in the instrument log.

To remove the active sequence, press **Clear All**. This action also clears the active method.

NOTE: Clear All is not enabled when using other configurations. MANUAL SEQUENCE is the default sequence in other configurations.

Inserting Priority Samples

Insert priority samples into an active sequence using the Priority Sample icon. Priority samples can be added even when the Eclipse is running a sequence.

NOTE: Be sure to match sequence order or priority status changes to changes in the GC data system sequence.

1. Press the **Priority Sample** icon . The Enter Priority Sample dialog box appears (Figure 5.5).

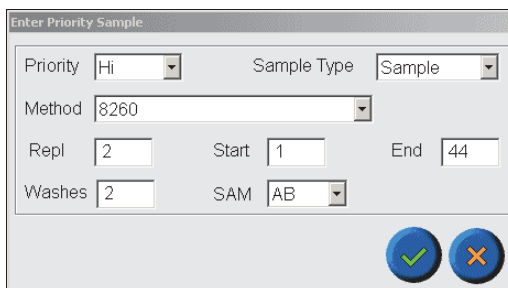

Figure 5.5. Enter Priority Sample dialog box

2. Select and enter the sequence parameters.
3. Press **?** to enter the priority sample line into the active sequence or **?** to exit the screen without adding the line.

NOTE: After pressing **?**, the software automatically compares the requested vial positions to the vials in the active sequence. If the requested vials do not overlap the vials already in the active sequence, the priority samples become added to the sequence, and the changes are automatically applied. If the requested vials overlap with vials in the active sequence, an error message appears, “Overlapping start and end vial positions.” The priority samples become added to the sequence, but the changes are *not* applied. To clear the error, correct the overlapping vial positions and press **Apply**.

4. Press **Apply** to apply the changes to the active sequence only.

NOTE: Changes made to the active sequence using **Apply** or **Save** become logged as sequence changes in the instrument log.

The priority sample line moves to the top of the sequence list or inserts into the sequence after the current sample run finishes. The priority sample line is highlighted red. After the priority sample line finishes, the Eclipse returns to the previously programmed sequence order.

For example, the Eclipse is programmed with the following active sequence and is running vial 2, rep 1:

Active Sequence		
Start	End	Reps
1	10	3

Insert a priority sample line as vial 11, 2 reps. The new active sequence appears:

Active Sequence		
Start	End	Reps
1	2	3
11	11	2
3	10	3

Using Methods

The Eclipse uses methods as operating parameters when running samples. Create, view, and edit methods from the Method Editor screen.

The currently active sequence designates the active method if the instrument uses the 4551A configuration. If using any other configuration, the operator designates an active method from the Active Method screen. Once a method becomes the active method, it can no longer be edited from the Method Editor screen.

To clear an active method, either clear the active sequence from the Active Sequence screen or designate another active method from the Active Method screen if the instrument is set to any configuration except 4551A. If a sequence is loaded, the Active Method screen's functions can no longer be accessed and its features are ghosted or grayed out.

Using the Method Editor

Generate new or edit existing methods from the Method Editor screen (Figure 5.6).

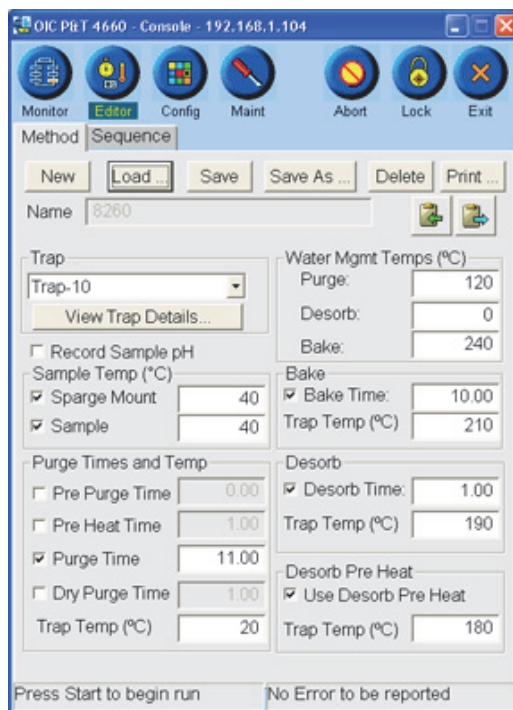

Figure 5.6. Method Editor screen

1. Access the Method Editor screen by pressing the **Editor** icon.
2. Press **New** to create a new method or press **Load** to access an existing method.

NOTE: An active method cannot be loaded from this screen. View an active method from the Active Method screen. See “Working with Configurations” on page 89 in this chapter for more information.

- If **New** is pressed, the Method Name dialog box appears. Enter the new method name using the onscreen keyboard. Press **OK** to save the changes or **Cancel** to exit the screen without saving the changes.
 - If **Load** is pressed, the Load Method dialog box appears. Select an existing method from the dropdown. Press ? to save the changes or ? to exit the screen without saving the changes.
3. Select or enter parameters for the specific method. See Chapter 4, “Method Editor Screen” on page 58 for more information. Press **Save** to save the changes, **Save As** to save the method with a new name, or **Cancel** to exit the screen without saving the changes.



Using Active Methods

For all sample introduction configurations except 4551A mode, load the active method into the Active Method screen.

1. Designate the active method from the Active Method screen.
 - a. Press **Load** to make a method active.
 - b. Select the method from the dropbox.
2. Make changes to the active method from the Active Method screen.
 - a. After making changes to the active method, press **Apply** to activate the changes.
 - b. Press **Save** to save the changes to the method file in the Method Editor.
3. The active sequence defaults to MANUAL SEQUENCE. In MANUAL SEQUENCE, nothing can be modified. Set the active method from the Active Method screen.
4. The number of Reps can be modified from the Active Method screen when selecting **Manual (No Sampler)** or **4660 Airtube option** for Sample Introduction. When selecting **AMPS** or **4552** for Sample Introduction, the number of Reps defaults to one, and this setting cannot be changed.

Loading and Running Samples

After choosing all configuration, sequence, and method parameters, load the samples.

- To start the run, press the **Start** icon , or allow an external device such as the Model 4552 to start the run.
- To suspend the run, press the **Pause** icon . Press **Pause** again to resume the run.
- To stop the run, press the **Abort** icon .

Manual Sample Loading

Complete the following steps to manually load the sample.

1. Allow the sample to reach ambient temperature before loading it into the syringe. Purging a subambient sample significantly affects purge (extraction) efficiency.
2. Remove the plunger from the sample syringe.
3. Open the sample bottle (or standard) and carefully pour the sample into the syringe barrel to just short of overflowing. Place your finger over the end of the syringe to hold the sample in the barrel.

4. Replace the syringe plunger and compress the sample.
5. Vent any residual air in the syringe while adjusting to the appropriate sample volume.
6. Add any applicable surrogate spiking solution and internal standard spiking solution through the syringe exit port using a 10- μ L syringe, if necessary.

Syringe Sample Injection (Manual Injection)

Perform these steps for manual syringe sample injection:

1. When the system is in purge ready, press **Start** to begin the analysis.
2. Attach the syringe to the four-way (or three-way) injection valve syringe port (Figure 5.7).
3. Turn the injection valve lever to the fill position.
4. Inject the sample into the sparge vessel and return the valve lever to the drain position.
5. Remove the syringe. The sample begins purging for the time set by the purge time set point. The system then cycles through the states according to the set point values.
6. After the Eclipse starts bake, rinse the sparge vessel with 5 mL of reagent water. Turn the valve back to drain, perform a manual drain, and repeat with a second flush (automatically performed by liquid-transfer autosamplers).
7. After bake completes, the system cycles to standby until the trap cools, then remains in purge ready for the next sample.

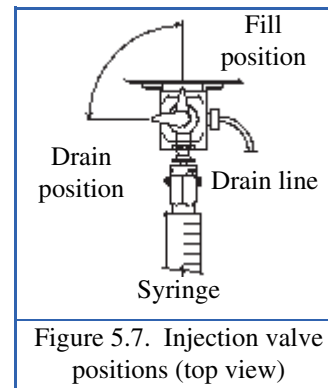

Figure 5.7. Injection valve positions (top view)

Needle Sparging

NOTE: The following instructions are only guidelines. Actual methodology may require different parameters (weight, volume, etc.) than those stated.

Purge-and-trap analysis using a needle sparger is similar to that using a frit sparger, with two main differences.

- The purging efficiency of a needle sparger is generally lower than for a frit sparger. Overcome this discrepancy by increasing the purge time, elevating the sample temperature during sparging, or a combination of both.
- Needle sparging lacks automatic sample draining at the end of the analysis. Therefore, drain the sparge vessel manually at the end of each cycle. Remove the vessel and empty the spent sample, then either clean the vessel or install a fresh sparge vessel.

The next two sections describe liquid sample and solid sample analyses using a needle sparger on the Eclipse.

Needle Sparging Liquid Samples

1. Disable the Eclipse's drain by accessing the Basic Configure screen and unchecking **Drain at Desorb** (see Chapter 4, "Basic Configure Screen" on page 65 for more information).
2. Follow the instructions in "Manual Sample Loading" on page 95 of this chapter.
3. Attach the syringe to the four-way (or three-way) injection valve's syringe port.
4. Turn the injection valve lever to the fill position (Figure 5.7).
5. Inject the sample into the sparge vessel and return the valve lever to the drain position (no draining occurs).
6. Press **Start** to begin the analysis. The sample purges for the set point time and cycles through the states according to the set point values.
7. After the Eclipse cycles to bake, loosen the lower sparge nut and slide off the sparge vessel.
8. Clean and rinse the sparge vessel before reinstalling, or install a cleaned and baked sparge vessel and tighten the sparge nut for a leak-free seal.
9. When the Eclipse cycles to purge ready, proceed with the next sample.

Needle Sparging Solid or Sludge Samples

A Mud-Dawg™ (PN 215061) provides an inert barrier to prevent contamination of transfer lines and valves. For soil (clay) samples, A Mud-Dawg stops or breaks apart a plug if it develops and moves up the sparger. For water samples, a Mud-Dawg reduces deposits on the side of the sparge vessels caused by foaming samples for improved reproducibility.

To attach a Mud-Dawg to a needle, bend the Mud-Dawg slightly and slide it on the needle, with the needle going through both holes (Figure 5.8). Place it 1–2" above the sample level.

Clean the Mud-Dawg by following the normal laboratory procedures for glassware or replace as an expendable item.

1. Weigh a clean, dry sparge vessel on an analytical balance and record the weight.
2. According to the current analytical method, weigh a known sample amount into the sparge vessel. A 1–5 g sample is typical, depending on the expected analyte concentration.
3. Install the sparge vessel containing the sample onto the Eclipse with the sparge vessel neck inserted properly into the sparge nut. Tighten the sparge nut for a leak-free seal.
4. If performing a heated sparge, set the Infra-Sparge™ Sample Heater option to the desired temperature set point.
5. Fill a 5-mL syringe with reagent water (see “Manual Sample Loading” on page 95 in this chapter).
6. Add any desired internal standard to the reagent water using a 10- μ L syringe.
7. Attach the 5-mL syringe to the Eclipse’s sample syringe port.
8. Turn the injection valve lever to the fill position (Figure 5.7).
9. Inject the reagent water into the sparge vessel and return the valve lever to the drain position (no draining occurs).
10. Press **Start** to begin the analysis.
11. After the Eclipse cycles to bake, loosen the sparge nut and remove the sparge vessel.
12. Clean, rinse, and dry the sparge vessel before weighing the next sample, or install a cleaned and baked sparge vessel and tighten the sparge nut for a leak-free seal.
13. When the Eclipse cycles to purge ready, proceed with the next sample.

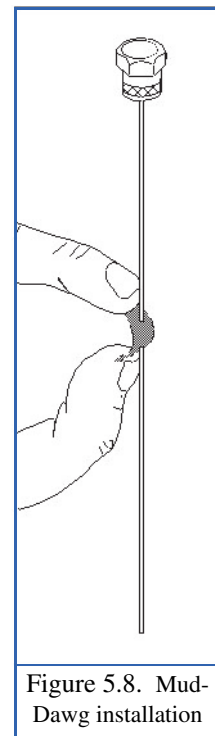

Figure 5.8. Mud-Dawg installation

Autosampling

For specific instructions on operating and programming the Eclipse with autosamplers or Air-Tubes, refer to Air-Tube Desorber instructions or the appropriate autosampler operator’s manual.

Trap Information

OI Analytical purge-and-trap sample concentrators use the following traps. The fitting attached to the purge inlet of the trap is stamped with a letter identifying the trap type. The purge outlet of the trap is stamped with “O.” Use the chart below to identify the trap and its contents.

Table 5.2. OI Analytical traps

Trap No.	Trap Contents	PN
7	Tenax	227348
8	Tenax/silica gel	227363
9	Tenax/silica gel/charcoal	219972
10	Tenax/silica gel/carbon molecular sieve	228122
11	VOCARB 3000	258830
12	BTEXTRAP	258848
524.3	Proprietary	326720

Trap Operating Conditions

Condition all traps prior to use. Conditioning eliminates contamination and assures uniform performance during the trap's lifetime. Use the recommended time and temperature conditions specified in the chart below. Although some of the trap materials can tolerate slightly higher temperatures than noted below, OI Analytical recommends the following temperatures for optimum performance and longer trap lifetimes. Purge times and sample volumes depend on compounds of interest or the specific method used. The following are general recommendations. Vary specific parameters to optimize for a particular application.

Table 5.3. Trap operating conditions

Trap No.	Conditioning	Desorb	Bake
7	210 °C 30 min	180 °C 0.5–4 min	200 °C 7–12 min
8	210 °C 30 min	180 °C 0.5–4 min	200 °C 7–12 min
9	210 °C 30 min	180 °C 0.5–4 min	200 °C 7–12 min
10	210 °C 30 min	190 °C 0.5–4 min	210 °C 7–12 min
11	250 °C 30 min	240 °C 0.5–4 min	250 °C 7–12 min
12	250 °C 30 min	240 °C 0.5–4 min	250 °C 7–12 min
524.3	250 °C 30 min	240 °C 0.5–4 min	250 °C 7–12 min



Chapter 6 Maintenance

This chapter provides maintenance information for the Eclipse.

Maintenance Screen

The Maintenance screen contains diagnostic and maintenance tools (Figure 6.1).

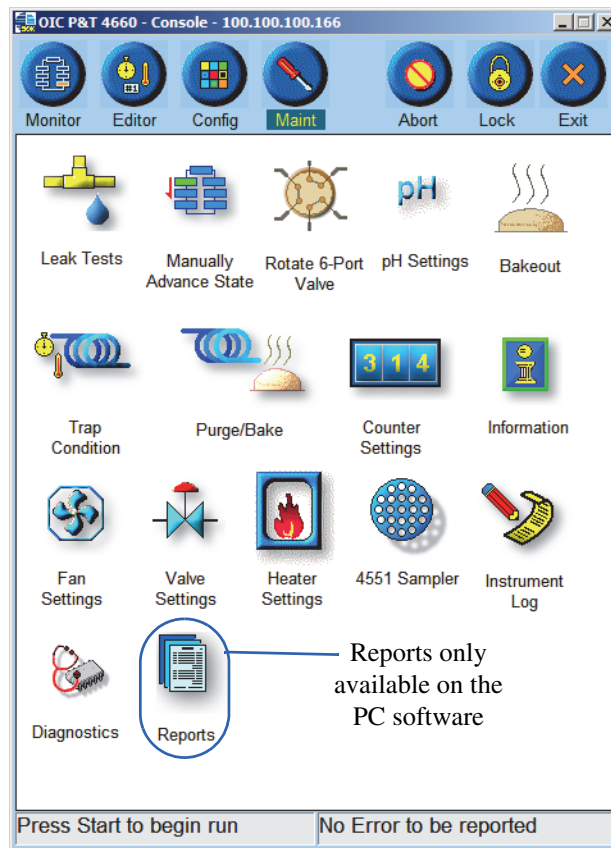

Figure 6.1. Maintenance screen

Leak Tests

Press the **Leak Test** icon to access the Maintenance: Leak Tests dialog box (Figure 6.2).

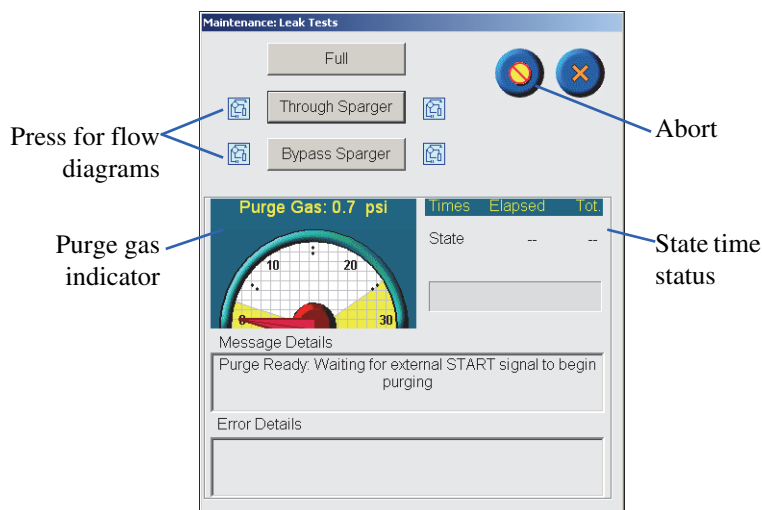



Figure 6.2. Maintenance: Leak Tests dialog box

Full	Performs a complete system leak test both through the sparger and bypassing the sparger.
Through Sparger	Performs a leak test with the dry purge valve in the normally open position (purge path). See Figure 18.19, “Leak test A (wet system)” on page 282 and Figure 18.20, “Leak test B (wet system)” on page 283.
Bypass Sparger	Performs a leak test with the dry purge valve in the normally closed position (dry purge path). See Figure 18.17, “Leak test A (dry system)” on page 280 and Figure 18.18, “Leak test B (dry system)” on page 281.
Purge Gas Indicator	Graphically displays the current purge gas pressure (psi).
State Time Status	Shows the current state’s elapsed time (minutes) or how long the state has run, and the state’s total time (minutes) or the entire time the state takes to complete.
Message Details	Displays status messages during the leak test.
Error Details	Displays any error messages relating to the leak test.

- Access detailed flow diagrams for the leak tests by pressing .
- Press  to abort the leak test.
- Press ? to exit the dialog box.

Through Sparger Leak Test

The Through Sparger leak test consists of parts A and B:

- When **Through Sparger** is pressed, the status bar shows the message “Wet leak part A.” During Part A, the sample pathway (excluding the trap) pressurizes to about 20 psi, which takes approximately 2.5 minutes, and then the gas automatically turns off (see Figure 18.19, “Leak test A (wet system)” on page 282). The system monitors pressure for approximately two minutes. If <0.8 psi pressure drop is detected during this time, the system passes this portion of the leak test and “Wet leak part B” begins. If the system does not pressurize to at least 15 psi, the leak check fails.
- The six-port valve rotates to the Load position, placing the trap on line (see Figure 18.20, “Leak test B (wet system)” on page 283). After observing the pressure drop due to the valve rotation, the system monitors pressure for about one minute. If <0.5 psi pressure drop is detected, the system passes this portion of the leak test. If the pressure exceeds 25 psi, the bake vent opens to relieve the pressure and the leak test fails.

Bypass Sparger Leak Test

The Bypass Sparger leak test consists of parts A and B:

- When **Bypass Sparger** is pressed, the status bar shows the message “Dry leak part A”. The system pressurizes to about 20 psi, which takes approximately 2.5 minutes, and then the gas automatically turns off (see Figure 18.17, “Leak test A (dry system)” on page 280). The system monitors pressure for approximately two minutes. If <0.8 psi pressure drop is detected during this time, the system passes this portion of the leak test and “Dry leak part B” begins. If the system does not pressurize to at least 15 psi, the leak check fails.
- The six-port valve rotates to the Purge position, putting the trap on line (see Figure 18.18, “Leak test B (dry system)” on page 281). After observing the pressure drop due to the valve rotation, the system monitors pressure for about one minute. If <0.5 psi pressure drop is detected, the system passes this portion of the leak test. If the pressure exceeds 25 psi, the bake vent opens to relieve the pressure and the leak test fails.

For both leak tests, if part A passes and part B fails, locate the leak in the six-port valve, water management, trap, or trap bulkhead areas. If part A fails, locate the leak outside of the trap area. For example, if the pressure dropped more than 0.8 psi during part A, the error display box shows an error message.

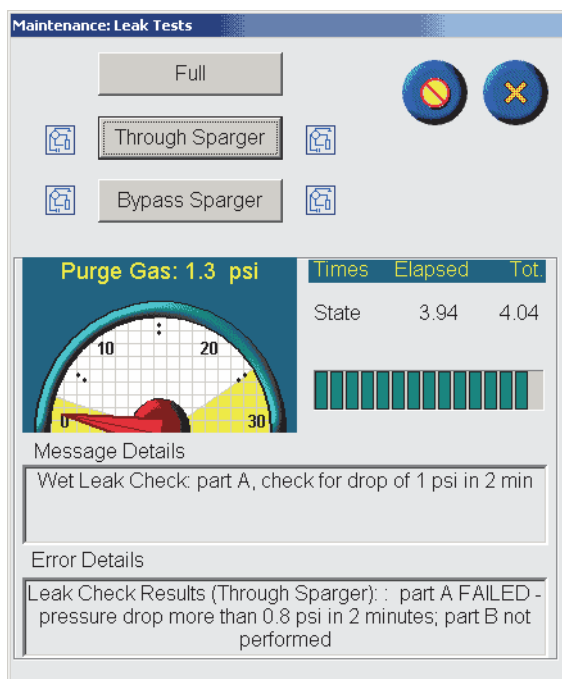

Figure 6.3. Leak check error message

Manually Advance State

Press the **Manually Advance State** icon to access the Maintenance: Change State dialog box (Figure 6.4).

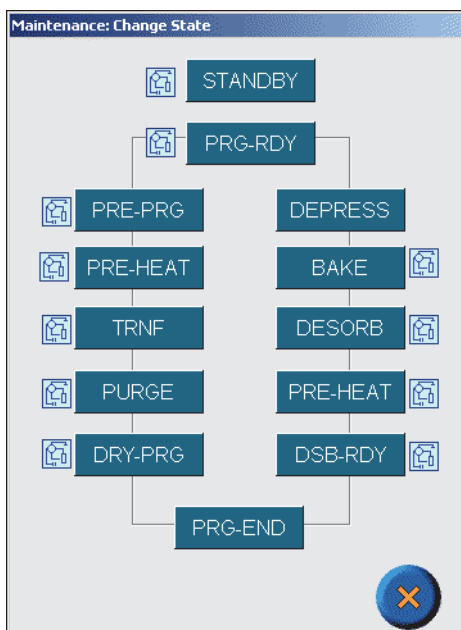

Figure 6.4. Maintenance: Change State dialog box

- Press the state's named icon to enter that state.

- Access flow diagrams associated with each state by pressing the flow diagram's icon.
- Press ? to exit the dialog box. Exiting the dialog box does not exit the state. The instrument remains in the last entered state until pressing **Abort**. A run cannot be started until this state is aborted.

Rotate 6-Port Valve

Press the **Rotate 6-Port Valve** icon to access the Maintenance: Rotate 6-Port Valve dialog box (Figure 6.5).

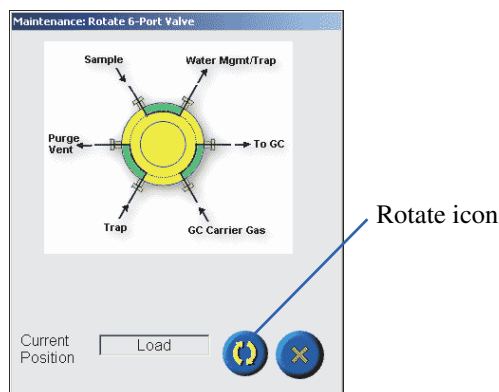

Figure 6.5. Maintenance: Rotate 6-Port Valve dialog box

- Press the Rotate icon to move the valve between the Load and Inject positions. After several seconds, the valve diagram reflects the valve position change.
Load is the default valve position.
Inject is the desorb position.
- Press ? to exit the dialog box.
- Press **Abort** to reset the Eclipse to the purge ready state.

pH Settings

pH Settings contains pHDetect module maintenance features such as calibrating the electrode and loading pH buffer. Pressing the **pH Settings** icon accesses the Maintenance: pH Settings dialog box (Figure 6.6).

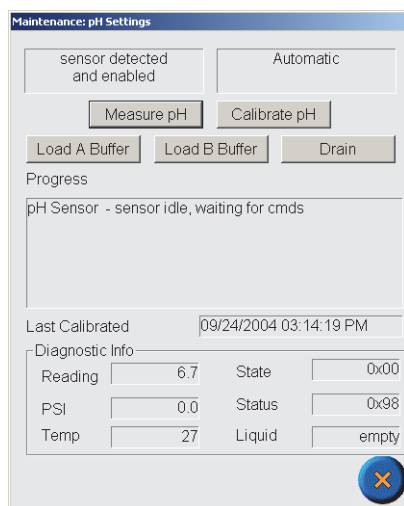

Figure 6.6. Maintenance: pH Settings dialog box

For complete information about the *pHDetect* module, please see Chapter 7, “*pHDetect*[™] Module” on page 134.

Bakeout

Bakeout conditions or cleans the entire system at elevated temperatures after contamination. The Eclipse automatically runs the bakeout method for the specified number of cycles. Pressing the **Bakeout** icon accesses the Maintenance: Bakeout dialog box (Figure 6.7).

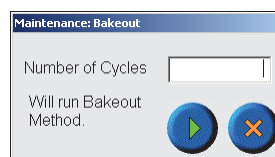

Figure 6.7. Maintenance: Bakeout dialog box

1. Enter the **Number of Cycles**.
2. Press > to start bakeout or ?to exit the screen without starting.

NOTE: The Eclipse contains bakeout method and configuration default files, which can be modified if preferred. Change the bakeout parameters using the Method Editor screen.

Trap Condition

Trap Condition prepares a new trap before use or bakes an old trap if contamination is suspected. Pressing the **Trap Condition** icon accesses the Maintenance: Trap Condition dialog box (Figure 6.8).

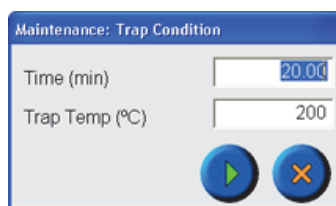

Figure 6.8. Maintenance: Trap Condition dialog box

The trap conditioning parameters automatically fill with the active method's bake time and temperature parameters. Change the parameters if desired using the following steps:

1. Enter the new trap conditioning parameters: **Time (min)** and the **Trap Temp (°C)**.

NOTE: Trap conditioning parameters depend on the type of trap. Refer to Chapter 5, "Trap Information" on page 99 for more details.

2. Press > to start trap conditioning or ?to exit the screen without starting.

Purge/Bake

Purge/Bake cycles the Eclipse through purge and bake *only* for a set number of cycles and provides an alternate way to condition a trap. Pressing the **Purge/Bake** icon accesses the Maintenance: Purge/Bake dialog box.

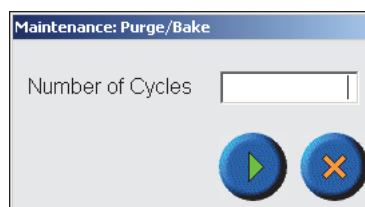

Figure 6.9. Maintenance: Purge/Bake dialog box

1. Enter the **Number of Cycles** (0–999) using the onscreen numeric keyboard.
2. Press > to start purge/bake or ?to exit the screen without starting. The instrument cycles through the current active method's purge and bake states.

NOTE: The Eclipse does not wait for a GC ready signal during this operation.

Counter Settings

Counters keep track of the Eclipse's key events and actions. To view the counters, press the **Counter Settings** icon to access the Maintenance: Counter Settings dialog box (Figure 6.10).



Figure 6.10. Maintenance: Counter Settings dialog box

- Reset the counters by checking the appropriate box and pressing **Reset Checked Items Now**.
- Press ?to exit the dialog box.

Information

Pressing the **Information** icon accesses the Maintenance: Information dialog box (Figure 6.11). Instrument and system information such as firmware and software versions display in this dialog box. The Serial Number information is text only and can be edited and saved.

NOTE: To upgrade the Eclipse firmware and software to version 2.1, contact OI Analytical technical support and reference the upgrade kit, part number 322469.

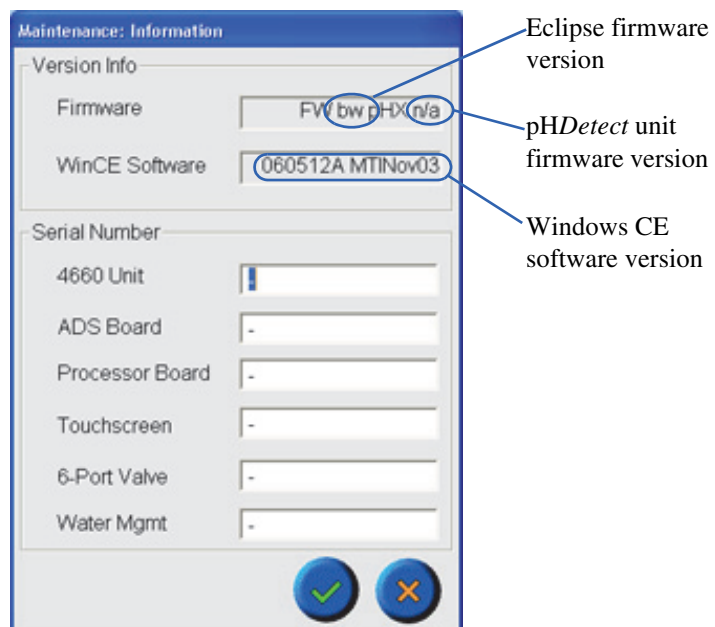

Figure 6.11. Maintenance: Information dialog box

Fan Settings

For future use, Fan Settings will directly control the Eclipse's fans for testing and diagnostic purposes. Press the **Fan Settings** icon to access the Maintenance: Fan Settings dialog box (Figure 6.12).

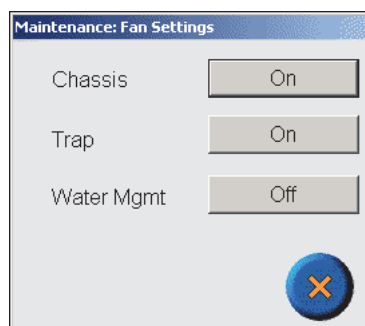

Figure 6.12. Maintenance: Fan Settings dialog box

Valve Settings

Valve Settings directly control the Eclipse's valves for testing and diagnostic purposes. Press the **Valve Settings** icon to access the Maintenance: Valve Settings dialog box (Figure 6.13).

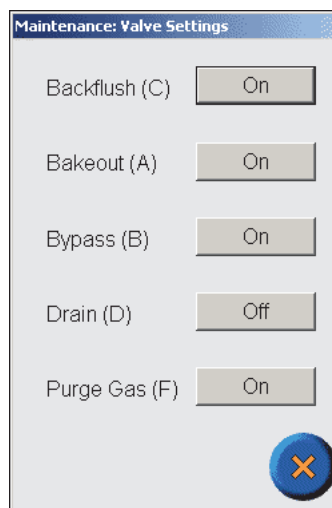

Figure 6.13. Maintenance: Valve Settings dialog box

- Turn the Backflush, Bakeout, Bypass, Drain, or Purge Gas valve **OFF** or **ON**.
- The dialog box displays the current state of each valve.
- Press ? to exit the dialog box.
- Press **Abort** to reset the instrument to purge ready.

Heater Settings

Heater Settings directly control the Eclipse's heated zones for testing and diagnostic purposes. Press the **Heater Settings** icon to access the Maintenance: Heater Settings dialog box (Figure 6.14).

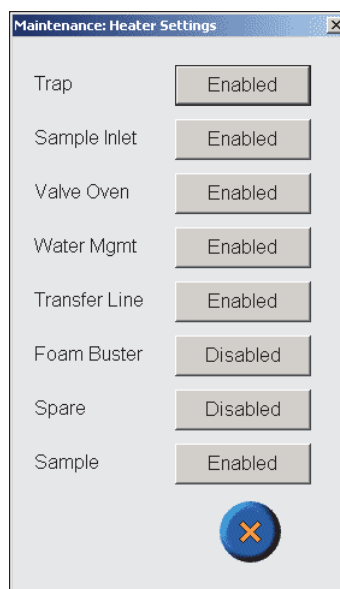

Figure 6.14. Maintenance: Heater Settings dialog box

- **Enable** or **Disable** each heated zone: Trap, Sparge Mount, Valve Oven, Water Management, Transfer Line, Foam Buster Option, Spare, or Sample.
- Press ?to exit the dialog box.
- Press **Abort** to reset the instrument to purge ready.

4551 Sampler

Directly control key Model 4551A Autosampler functions for testing and diagnostic purposes. Press the **4551 Sampler** icon to access the Maintenance: 4551 Sampler dialog box (Figure 6.15).

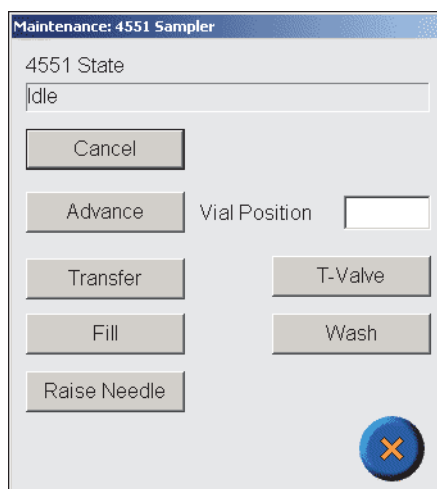

Figure 6.15. Maintenance: 4551 Sampler

- Enable the following autosampler functions:
Advance moves the carousel to the designated **Vial Position**.
Transfer sends the sample loop contents to the sparge vessel.
Fill sends sample from the current autosampler position to the sample loop.
Raise Needle lifts up the needle.
T-Valve actuates the transfer valve.
Wash rinses the needle and fills the sample loop with rinse water.
- Press **?** to exit the dialog box.
- Press **Abort** to reset the Eclipse and the Model 4551A.

Instrument Log

Access and view the Eclipse's maintenance history, operator's log, and OI service log. Press the **Instrument Log** icon to access the Maintenance: Instrument Log dialog box (Figure 6.16).

NOTE: An OI Analytical Service Personnel authentication password is required to access the OI service log.

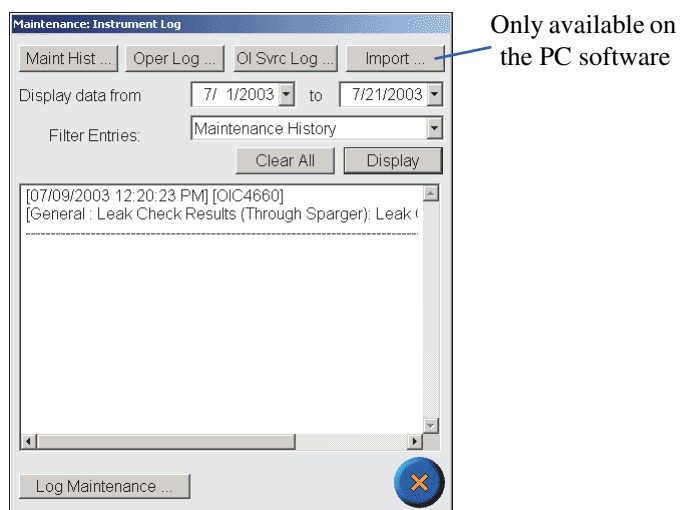

Figure 6.16. Maintenance: Instrument Log dialog box

Display a Log Entry

1. Specify the time frame by choosing the **Display data from** and **to** dates.
2. **Filter Entries** by choosing an option from the dropdown:

Run History	Includes starts, aborts, Foam Sensor activations, SOS™ activations, manual drains, and heater errors.
Maintenance History	Includes leak checks and manual instrument log entries.

OI Service History	Includes log entries made by OI Analytical service personnel.
pH Readings	Includes sample pH values, pH calibrations.
Configuration Changes	Includes all changes to configurations.
Method Changes	Includes all changes to methods.
Sequence Changes	Includes all changes to sequences.
Trap Changes	Includes entries logged with “Chg trap” selection
Operator Log	Includes manual operator log entries.

3. Press **Display**. The log entries display chronologically with the most recent first. Press **Clear All** to delete the displayed entries.
4. Press ?to exit the dialog box.

Adding an Instrument Log Entry

1. Press **Maint Hist...** to add an instrument log entry. The Instrument Log: Add Entry dialog box appears (Figure 6.17).

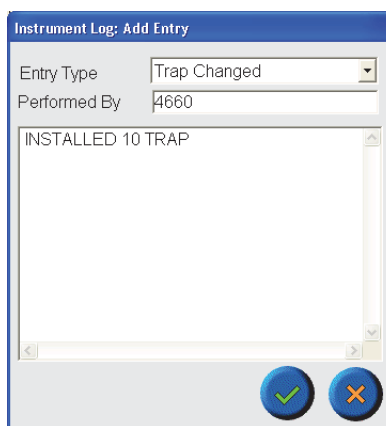

Figure 6.17. Instrument Log: Add Entry dialog box

2. Select an **Entry Type** from the dropbox: **General, Gas Filter Replaced, pH Buffer Replaced, pH Calibrated, Trap Changed, or Water Mgmt Fitting Changed.**
3. Enter the log entry details using the onscreen keyboard. Press ?to save the changes or ?to exit the screen without saving the changes.

Adding an Operator Log Entry

1. Press **Oper Log** to add an operator log entry. The Operator Log: Add Entry dialog box appears (Figure 6.18).

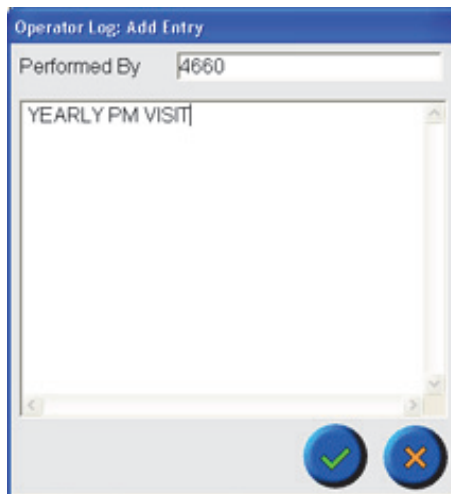

Figure 6.18. Operator Log: Add Entry dialog box

2. Enter the log entry details using the onscreen keyboard.
3. Press ?to save the changes or ?to exit the screen without saving the changes.

Importing Data

Transfer data from the Eclipse to its database on the PC for reporting and archiving. This option is only available on the Eclipse PC software. Pressing **Import...** accesses the Import Data dialog box (Figure 6.19).

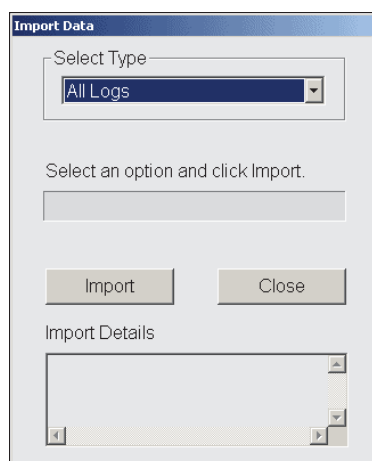

Figure 6.19. Import Data dialog box

1. Select the type of data to be imported: **All Logs, Configuration Changes, Maintenance History, Method Changes, Operator Log, pH Readings, Run History, Sequence Changes, or Trap Changes.**

2. Press **Import** to import the data or **Close** to exit the dialog box without importing the data. The Import Details field displays Import information.
3. Access the information by pressing the **Reports** icon.

Log Maintenance

Pressing the **Log Maintenance** icon accesses the Log Maintenance dialog box (Figure 6.20).

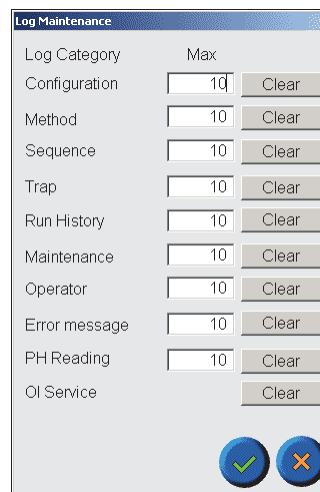

Figure 6.20. Log Maintenance dialog box

- Set the maximum number of log entries stored on the Eclipse for each category (1–200 entries). The default number is 10.
- Press **Clear** to erase the entries for a given category.

Diagnostics

Press the Diagnostics icon to access the Diagnostics dialog box (Figure 6.21).

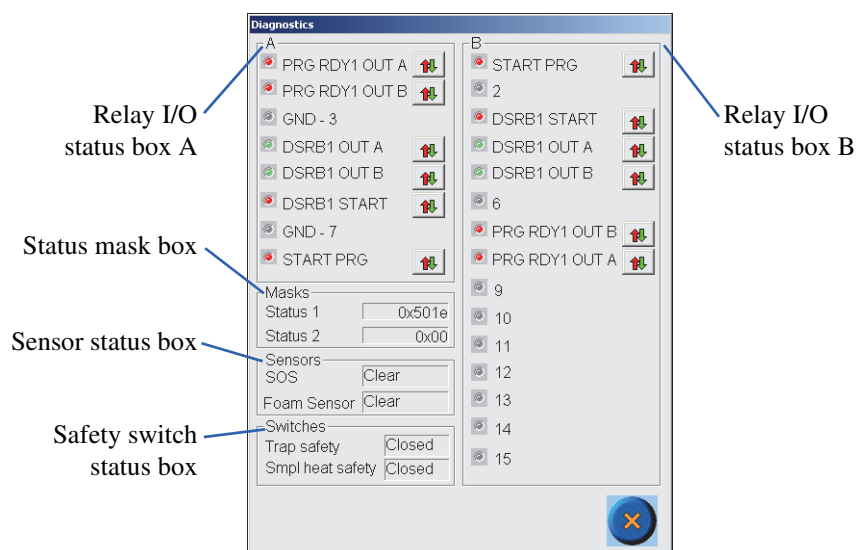

Figure 6.21. Diagnostics dialog box

Relay I/O Status Boxes A and B

The inputs and outputs shown in the status boxes associate with the Relay Input/Output (I/O) A and B port on the back of the Eclipse (Figure 6.22).

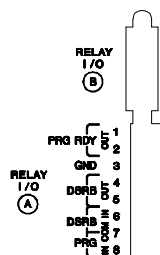



Figure 6.22. Relay I/O A and B port

NOTE: Press  to change the relay status.

NOTE: Relay I/O B pins 2, 6, and 10 are ground.

Table 6.1. Relay I/O status boxes A and B

Diagnostic Field	Description	Pins	Red Indicator Status	Green Indicator Status
PRG RDY1 OUT A and PRG RDY 1 OUT B	Purge ready output relay tells external devices such as the Model 4552 Autosampler that the Eclipse is in purge ready.	Connector A pins 1 and 2, connector B pins 7 and 8	On/closed when the Eclipse is in purge ready	Off/open when the Eclipse is in any state other than purge ready
DSRB1 OUT A and DSRB1 OUT B	Desorb output relay sends a signal to an external device at the beginning of desorb. This relay is most commonly used to send a start signal to the GC.	Connector A pins 4 and 5, connector B pins 4 and 5	On/closed at the start of desorb for about five seconds if “Output At Start of Desorb” is selected in the active configuration On/closed at the start of bake for about five seconds if “Output At Start of Bake” is selected in the active configuration	Off/open during all other states
DSRB1 START and GND	Desorb start input, most commonly connected to the GC, receives the GC ready signal. If “Wait For Ready At Desorb” is selected in the active configuration, the Eclipse monitors this input while it is in desorb ready before advancing to desorb. The Eclipse advances to desorb only after receiving the start input signal.	Connector A pins 6 and 7, connector B pins 3 and 10	If the GC sends normal signals: not ready or no start input If the GC sends inverted signals: ready or start	If the GC sends normal signals: ready or start If the GC sends inverted signals: not ready or no start input
START PRG and GND	Purge start input, most commonly connected to an external device such as the Model 4552 Autosampler, receives a signal at purge ready to advance to the next state. If “Wait for Start at Purge Ready” is selected in the active configuration, the Eclipse monitors this input while in purge ready before advancing to the next state.	Connector A pins 7 and 8, connector B pins 1 and 2	No start input detected	Start input detected

Status Mask Box

OI Analytical Customer Support personnel use the status masks for diagnostic purposes.

Sensor Status Box

The sensor status box shows the current status of the Sparge Overfill Sensor (SOS™) and the Foam Sensor options. The following status messages appear in this box:

Not Present	The sensor is not installed or is not plugged into the I/O board.
Clear	The sensor does not detect liquid or foam and the sensor is enabled in the active configuration.
Clear*	The sensor does not detect liquid or foam and the sensor is not enabled in the active configuration.
Tripped	The sensor detects liquid or foam and the sensor is enabled in the active configuration.
Tripped*	The sensor detects liquid or foam and the sensor is not enabled in the active configuration.

Safety Switch Status Box

The safety switch status box shows the current status of the trap safety switch and sample heater safety switch.

The trap safety switch consists of the magnetic door switch and trap overtemperature switch in series.

NOTE: The trap safety switch status does not operate on units with serial numbers starting with “A.” The status always reports “Closed.”

The sample heater safety switch consists of the magnetic door switch and sample overtemperature switch in series. The sample heater safety switch is only relevant when the Infra-Sparge™ Heater option is installed. The following status messages appear in this box:

Open	The sample cover is off or the sample overtemperature switch is tripped due to an overheating condition.
Closed	The sample cover is on and the over temperature switch is not tripped.

Reports

The Reports feature generates and accesses reports compiled from the Eclipse's database and is only available on the Eclipse PC software; versions prior to 2.1 require Microsoft Access be installed on the PC. Press the **Reports** icon to open the Reports screen (Figure 6.26).

Importing Reports

1. Connect to the Eclipse using the PC software by right-clicking the Device icon in the Eclipse LaunchPad and selecting **Connect to Eclipse** or by double-clicking the device icon.
2. Press the **Maint** icon to access the Maintenance screen.
3. Press **Instrument Log** to access the Maintenance: Instrument Log dialog box as shown in Figure 6.23.

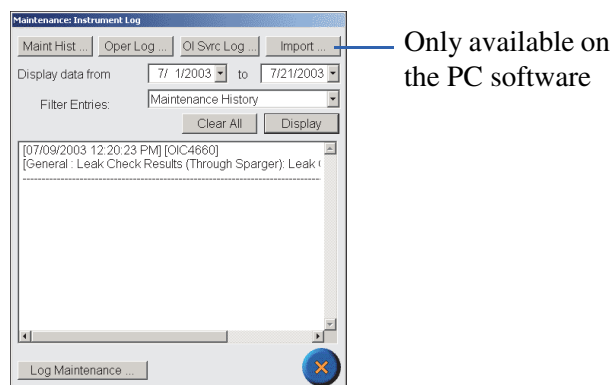

Figure 6.23. Maintenance: Instrument Log dialog box

4. Select **Import** to access the Import Data dialog box (refer to Figure 6.19).

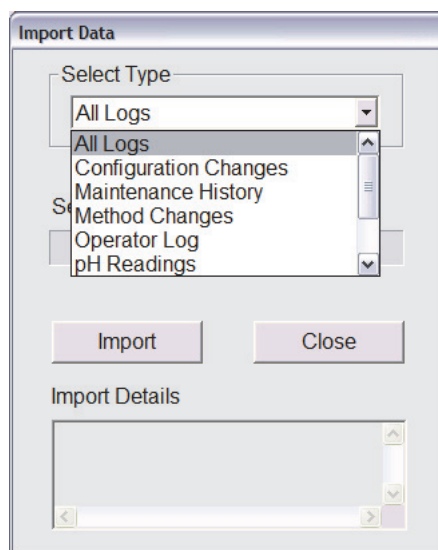

Figure 6.24. Import Data dialog box

- Under **Select Type**, select the type of logs to import, and press **Import**.

NOTE: Depending upon the number of logs being imported and the number of file entries in each log, this operation may take several minutes.

- Press **Close** to exit the dialog box once the data has been imported.

View/Print Reports

- Connect to the Eclipse using the PC software by right-clicking the Device icon in the Eclipse LaunchPad and selecting **Connect to Eclipse** or by double-clicking the **Device** icon.
- Press the **Maint** icon to access the Maintenance screen.
- From the Maint screen, select **Reports**; alternatively, right click on the device icon in the Eclipse LaunchPad to access Eclipse Reporter as shown in Figure 6.25.



Figure 6.25. Right-click the Device to access the Eclipse Reporter

- Select the **Start Date** and **Time** and **End Date** and **Time** to define the report (see Figure 6.26).

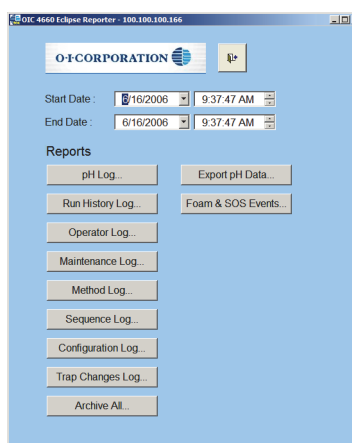

Figure 6.26. Eclipse Reporter Reports screen

- Select the report type to view and/or print by clicking the appropriate button; an example of a pH Log report is shown in Figure 6.27.

OI Analytical 4660		
PH Readings		
Date/Time of Entry	User ID	Log Entry Details
5/18/2006 2:10:15PM	OIC4660	vial pos 3, pH = 4.6, last cal 05/18/2006 (pos->pos tion)
5/18/2006 2:31:15PM	OIC4660	vial pos 4, pH = 4.6, last cal 05/18/2006 (pos->pos tion)
5/18/2006 2:52:09PM	OIC4660	vial pos 5, pH = 4.7, last cal 05/18/2006 (pos->pos tion)
5/18/2006 3:13:03PM	OIC4660	vial pos 6, pH = 4.6, last cal 05/18/2006 (pos->pos tion)
5/18/2006 3:34:22PM	OIC4660	vial pos 7, pH = 4.6, last cal 05/18/2006 (pos->pos tion)
5/18/2006 3:55:18PM	OIC4660	vial pos 8, pH = 4.1, last cal 05/18/2006 (pos->pos tion)
5/18/2006 4:16:09PM	OIC4660	vial pos 9, pH = 2.7, last cal 05/18/2006 (pos->pos tion)
5/18/2006 4:37:07PM	OIC4660	vial pos 10, pH = 2.7, last cal 05/18/2006 (pos->pos tion)
5/18/2006 4:57:35PM	OIC4660	vial pos 11, pH = 2.7, last cal 05/18/2006 (pos->pos tion)
5/18/2006 5:18:29PM	OIC4660	vial pos 12, pH = 2.7, last cal 05/18/2006 (pos->pos tion)
5/18/2006 5:39:52PM	OIC4660	vial pos 13, pH = 2.7, last cal 05/18/2006 (pos->pos tion)
5/18/2006 6:00:47PM	OIC4660	vial pos 14, pH = 2.7, last cal 05/18/2006 (pos->pos tion)
5/18/2006 6:21:41PM	OIC4660	vial pos 15, pH = 2.7, last cal 05/18/2006 (pos->pos tion)
5/18/2006 6:42:34PM	OIC4660	vial pos 16, pH = 2.7, last cal 05/18/2006 (pos->pos tion)
5/18/2006 7:03:28PM	OIC4660	vial pos 17, pH = 1.3, last cal 05/18/2006 (pos->pos tion)
5/18/2006 7:24:27PM	OIC4660	vial pos 18, pH = 1.1, last cal 05/18/2006 (pos->pos tion)
5/18/2006 7:45:26PM	OIC4660	vial pos 19, pH = 0.9, last cal 05/18/2006 (pos->pos tion)

Figure 6.27. Example pH Log Report

- To print the information, click the printer icon in the upper left corner of the window.

Exporting Reports

- Connect to the Eclipse using the PC software by right-clicking the Device icon in the Eclipse LaunchPad and selecting **Connect to Eclipse** or by double-clicking the **Device** icon.
- Press the **Maint** icon to access the Maintenance screen.
- From the Maint screen, select **Reports**; alternatively, right click on the Device icon in the Eclipse LaunchPad to access Eclipse Reporter as shown in Figure 6.25.
- Select the **Start Date** and **Time** and **End Date** and **Time** to define the report (see Figure 6.26).
- Export the appropriate report as follows:
 - To export pH data, click the button labeled **Export pH Data**.
 - To export Foam and SOS information, click the button labeled **Foam & SOS Events**.
- Complete the following Export Data options (refer to Figure 6.28):
 - Output Delimiter** – Choose from Tab Delimited, Comma Delimited, or Space Delimited data.
 - Directory** – Select the directory where the file will be saved.
 - Append or Overwrite** – Select the appropriate radio button to append to an existing file or overwrite an existing file.
 - Include Header** – Select this option to include column header labels in the export file.

- e. **Filename** – Type a filename for the exported data.
- f. **Append Date Time Stamp to Filename** – Select to append the current date and time stamp to the filename. For example, a filename of *stat* with the *Append Date Time Stamp* option selected for the date *July 8, 2006* and current time of *10:20:54 AM* would be named as follows:

```
stat 20060806 10-20-54 AM.txt
```

- g. **Include Statistics** – This option is for pH data only and will add the Total Number of pH Readings and the Average pH Value to the exported data.

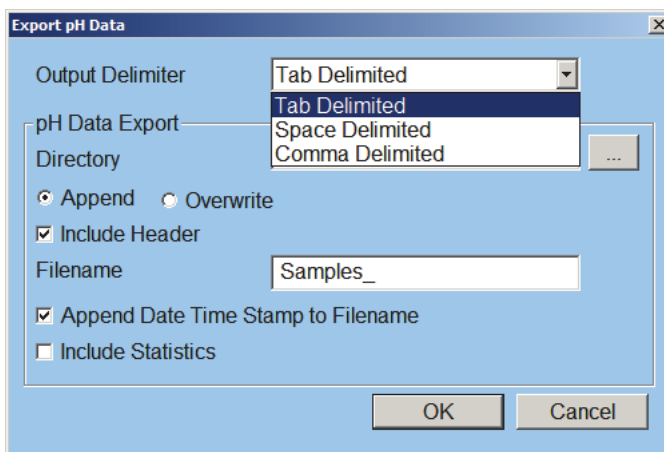

Figure 6.28. Export pH Data dialog box

7. Figure 6.29 shows an example of exported pH Data:

Date	Time	Operator	ID	Vial#	Measured pH	Detail Message
05/15/2006	10:24:13			OIC4660	N/A	"pH Express auto-calibration completed"
05/15/2006	10:47:04			OIC4660	1	"vial pos 1, pH = 2.1, last cal 05/15/2006"
05/15/2006	11:08:00			OIC4660	2	"vial pos 2, pH = 2.0, last cal 05/15/2006"
05/15/2006	11:20:31			OIC4660	3	"vial pos 3, pH = 2.0, last cal 05/15/2006"
05/15/2006	11:33:25			OIC4660	4	"vial pos 4, pH = 2.0, last cal 05/15/2006"
05/15/2006	13:22:37			OIC4660	N/A	"pH Express auto-calibration completed"
05/15/2006	14:44:38			OIC4660	1	"vial pos 1, pH = 0.9, last cal 05/15/2006"
05/15/2006	15:05:30			OIC4660	2	"vial pos 2, pH = 0.9, last cal 05/15/2006"
05/15/2006	15:26:24			OIC4660	3	"vial pos 3, pH = 0.8, last cal 05/15/2006"
05/15/2006	15:47:23			OIC4660	4	"vial pos 4, pH = 0.8, last cal 05/15/2006"
05/15/2006	16:08:13			OIC4660	5	"vial pos 5, pH = 2.4, last cal 05/15/2006"
05/15/2006	16:29:12			OIC4660	6	"vial pos 6, pH = 3.0, last cal 05/15/2006"
05/15/2006	16:50:08			OIC4660	7	"vial pos 7, pH = 3.1, last cal 05/15/2006"
05/15/2006	17:11:01			OIC4660	8	"vial pos 8, pH = 3.1, last cal 05/15/2006"
05/15/2006	17:31:56			OIC4660	9	"vial pos 9, pH = 4.4, last cal 05/15/2006"
05/15/2006	17:52:48			OIC4660	10	"vial pos 10, pH = 4.7, last cal 05/15/2006"
05/15/2006	18:13:47			OIC4660	11	"vial pos 11, pH = 4.6, last cal 05/15/2006"
05/15/2006	18:34:38			OIC4660	12	"vial pos 12, pH = 4.6, last cal 05/15/2006"
05/15/2006	18:55:31			OIC4660	13	"vial pos 13, pH = 1.3, last cal 05/15/2006"
05/15/2006	19:16:24			OIC4660	14	"vial pos 14, pH = 1.0, last cal 05/15/2006"
05/15/2006	19:37:22			OIC4660	15	"vial pos 15, pH = 0.9, last cal 05/15/2006"
05/15/2006	19:58:16			OIC4660	16	"vial pos 16, pH = 0.9, last cal 05/15/2006"
05/15/2006	20:19:15			OIC4660	17	"vial pos 17, pH = 2.0, last cal 05/15/2006"
05/15/2006	20:40:09			OIC4660	18	"vial pos 18, pH = 2.7, last cal 05/15/2006"
05/15/2006	21:01:12			OIC4660	19	"vial pos 19, pH = 2.9, last cal 05/15/2006"
05/15/2006	21:22:06			OIC4660	20	"vial pos 20, pH = 3.0, last cal 05/15/2006"
05/15/2006	21:43:02			OIC4660	21	"vial pos 21, pH = 4.3, last cal 05/15/2006"
05/15/2006	22:03:56			OIC4660	22	"vial pos 22, pH = 4.6, last cal 05/15/2006"
05/15/2006	22:24:51			OIC4660	23	"vial pos 23, pH = 4.3, last cal 05/15/2006"
05/15/2006	22:45:50			OIC4660	24	"vial pos 24, pH = 4.7, last cal 05/15/2006"
05/15/2006	22:58:16			OIC4660	25	"vial pos 25, pH = 1.2, last cal 05/15/2006"

Figure 6.29. Example exported pH data

Hardware Maintenance

Exterior Maintenance

Wipe exterior surfaces with a lint-free, nonabrasive cloth to remove loose dust. Do not use abrasive cleaners. Wipe up any spills immediately with a soft cloth dampened with water. Wipe dry with a soft cloth. Neutralize corrosive spills immediately with an appropriate compound.

Clean the touchscreen using the following steps:

CAUTION:

Do not use cleansers with organic solvents. Organic solvents may partially dissolve the display, rendering the display permanently smudged or illegible.

8. Turn off power to the Eclipse to prevent the instrument from responding to pressure to the screen during cleaning.
9. Gently wipe the screen with a lint-free, nonabrasive cloth and a mild, inorganic glass cleaner.

Maintaining the Trap

After periods of extended use, a trap begins to degrade, causing performance loss. Symptoms include lower sensitivity to selected components in a standard run and increased pressure to maintain 40 mL/minute flow during purge.

Changing the Trap

Follow these instructions to install a new trap:

WARNING:

Turn off the power and unplug the Eclipse before performing any interior maintenance, including changing the trap.

1. Turn off the Eclipse and unplug the unit.
2. Open the pneumatics access cover.

NOTE: A safety switch automatically cuts trap power when the Eclipse is not turned off and the cover is open.

3. Remove the trap access cover located in the Eclipse's back left corner by pressing both sides of the stainless steel cover and lifting upward.
4. Unplug the yellow trap thermocouple connector.
5. Loosen both E/1" female nuts with a wrench. Loosening the fittings with a back-up wrench on the bulkhead is not necessary.
6. Remove the trap from the unit.
7. Position the new trap so that the outlet fitting nut (designated by a "O" on the trap nut) is aligned with the trap bulkhead fitting located closest to the Eclipse's center wall, and the inlet fitting nut (stamped with a number indicating the trap type) is aligned with the water management fitting (Figure 6.30).

NOTE: To minimize the risk of stripping threads, begin threading both nuts into their respective fittings simultaneously, ensuring that the arms of the trap are parallel to one another and perpendicular to the bulkhead.

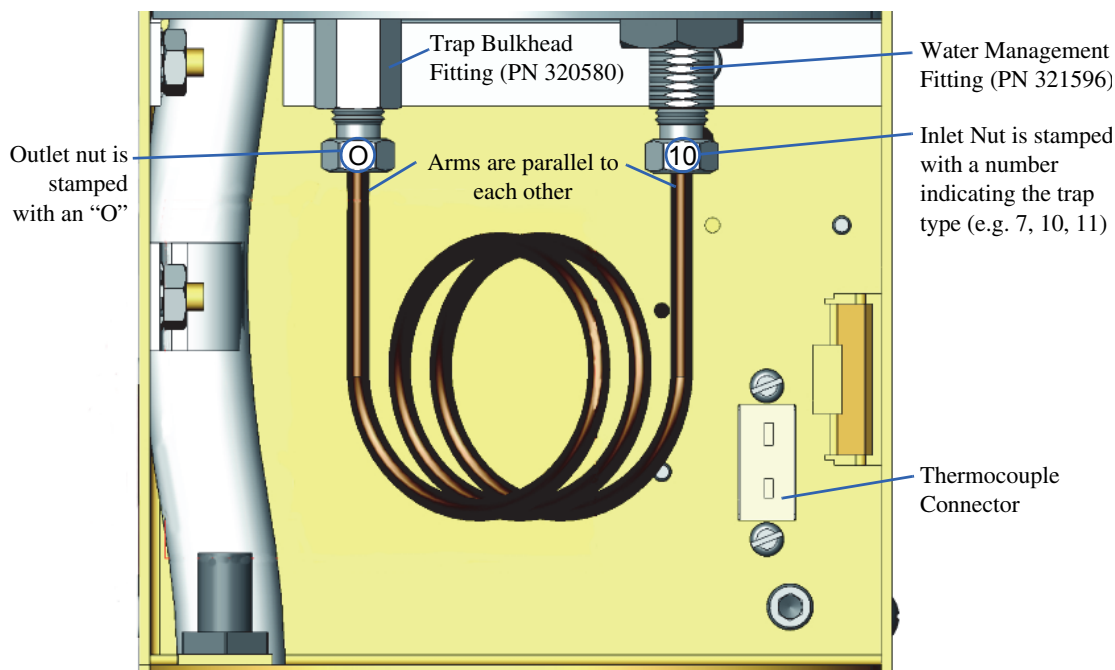

Figure 6.30. Maintenance: Identifying the trap components

8. Finger-tighten both nuts at the same time. Then, tighten with a wrench $\frac{1}{2}$ to $\frac{3}{4}$ turn.
9. Plug in the thermocouple. Position the thermocouple wire so it does not touch the trap tubing.
10. Replace the stainless steel trap access cover and close the pneumatics access cover.
11. Turn on the power. Perform a leak test on the system (see “Leak Tests” on page 102 in this chapter).
12. Condition the new trap as described in the next section, “Conditioning the Trap” on page 124.

Conditioning the Trap

Condition each new trap using the recommended settings before use. Also, keep a reference trap sealed and on hand to test system performance, if necessary.

NOTE: Trap conditioning parameters depend on the type of trap. See Chapter 5, “Trap Information” on page 99 for more details.

1. Press the **Maint** icon to access the Maintenance screen (Figure 6.1).

2. Press the **Trap Condition** icon. The Maintenance: Trap Condition dialog box appears (Figure 6.31).

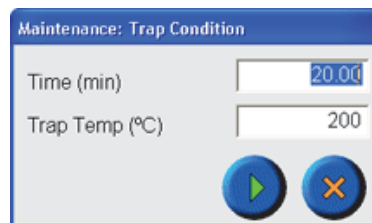

Figure 6.31. Maintenance: Trap Condition dialog box

The trap conditioning parameters automatically fill with the active method's bake time and temperature parameters. Change the parameters if desired using the following steps:

1. Enter the new trap conditioning parameters: **Time (min)** and the **Trap Temp (°C)**.

NOTE: Trap conditioning parameters depend on the type of trap. Refer to Chapter 5, "Trap Information" on page 99 for more details.

2. Press > to start trap conditioning or ? to exit the screen without starting.

Maintaining the Sparger

The Eclipse accommodates either frit or needle spargers (5 or 25 mL) with minimal hardware changes (see Chapter 3, "Installing Plumbing Connections" on page 35 or Chapter 3, "Installing the Needle Sparger Option" on page 35).

To clean a sparger, rinse thoroughly several times with reagent water and bake in an oven following normal laboratory procedures. Use solvents only when water does not sufficiently clean the sparger. Use a solvent that does not interfere with the detector.

Maintaining the Purge-Drain Needle

Clean or replace the purge-drain needle located below the sparge mount, as necessary.

1. Loosen the two screws at the four-way (or three-way) valve bracket.
2. Loosen the Q/qy" extended fitting at the top of the sparge mount.
3. Lift the bracket and four-way (or three-way) valve. Slide the needle out of the glassware.
4. Loosen the needle assembly from the bottom of the four-way (or three-way) valve with a Q/r" wrench and remove the needle.
5. Remove the Q/qy" Teflon® ferrule from the sparge mount fitting.
6. Rinse the needle's interior and exterior with methanol.

7. Reattach the needle or attach a new needle by tightening the needle assembly to the bottom of the four-way (or three-way) valve.
8. Slide the Q/qy" extended fitting nut and new Q/qy" Teflon® ferrule over the needle.
9. Slide the entire assembly (bracket, valve, needle, nut, and ferrule) into the sparge mount and glassware.
10. Position the needle so it lightly touches the fritted material at the bottom of the sparger.
11. Tighten the bracket, extended fitting, and ferrule.

Interior Maintenance

The following maintenance procedures involve changing or upgrading specific Eclipse interior components. OI Analytical authorizes only the following outlined procedures for customer maintenance.

WARNING:

Turn off power and unplug the Eclipse before performing any interior maintenance.

Any other procedures involving the Eclipse interior components should only be performed by OI Analytical-trained Customer Support personnel.

Maintaining the Sparge Filter Tube

Clean or replace the sparge filter tube located on the back of the sparge mount, as necessary.

1. Turn off the power and unplug the Eclipse.
2. Open the pneumatic access cover and remove the valve oven cover.
3. Loosen the Q/qy" nuts holding the filter tube assembly (PN 321932) at both the top of the four-port cross and sparge mount with a E/i" wrench. Remove the filter tube assembly.
4. Remove the sample filter adapter (PN 321659S) from the top of the four-port cross.
5. Clean the sparge filter adapter by rinsing it with methanol from the unfiltered side. Dry it with a stream of ultrapure nitrogen or helium.
6. Bake the sparge filter adapter at 100–150 °C for 30 minutes.
7. Replace the sparge filter adapter on the top of the four-port cross. Tighten as much as possible (approximately 160 inch-pounds torque).
8. Replace the filter tube assembly by attaching one end to the sparge filter adapter and the other end to the sparge mount.
9. Replace the covers.

If foaming samples are common, keep one filter (PN 321659S) baking in the GC oven at all times for quick replacement.

Rinsing the Sample Pathway

Many performance problems associated with purge-and-trap (P&T) methods are symptomatic of either a leak in the system or the normal wear-and-tear on the instrument and can be corrected or prevented by incorporating a few simple steps into your routine preventative maintenance procedures.

This instruction sheet describes a routine procedure for rinsing the P&T sample pathway with methanol. OI Analytical recommends that this procedure be performed on a regular basis (either monthly or quarterly, depending on actual sample load) or as indicated by the presence of one or more of the performance problems listed. This procedure should be performed after determining that the system is free of any leaks. Once each year, during the annual Preventative Maintenance, the Eclipse transfer line should also be rinsed with methanol.

Symptoms Indicating the Need to Rinse the Sample Pathway with Methanol

- Poor recoveries of late eluting or brominated compounds
- High %RSDs for compounds eluting after the xylenes in an initial calibration, caused by low response on some standards (low response of standards during a calibration can also be caused by a dirty ion source in the MS)
- Excessive carryover
- Low response for acrolein or 2-chloroethyl vinyl ether (2-CLEVE)
- Low response for ketones or alcohols
- Poor peak shapes, especially for ketones and alcohols
- Purge pressure above 14 psi

Required Equipment

1. A Blank trap (#0, part number 228114)
2. A 10-mL syringe
3. A “rinsing tool” to connect the syringe to the outlet side of the water management fitting.
4. A 3/8" wrench
5. HPLC- or reagent-grade methanol

WARNING

Methanol is toxic. Take appropriate precautions.

If desired, a “P&T Rinsing Kit” can be purchased from OI Analytical as part number 324536. The kit contains all of the tools necessary to rinse the sample pathway, as well

as the instruction sheet. If the analytical trap will be changed as part of the procedure, it must be purchased separately.

Rinsing the Eclipse Sample Pathway (not including the transfer line)

1. From the Maintenance screen, step the instrument to either the “Standby” or “Purge Ready” state (refer to Figure 6.32).

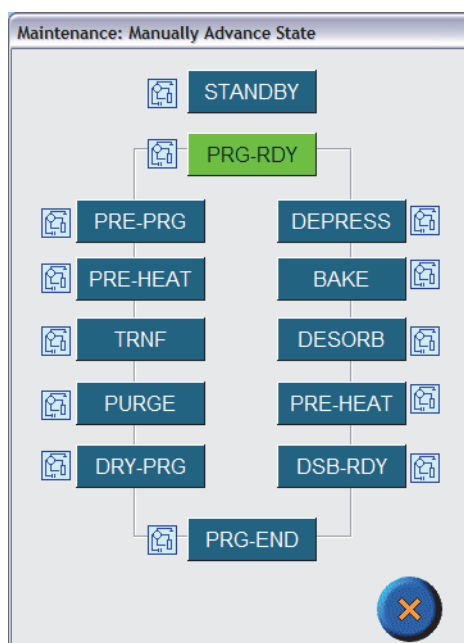

Figure 6.32. Instrument in “Purge-Ready”

2. Verify that the 6-port valve is in the “Load” position (refer to Figure 6.33).

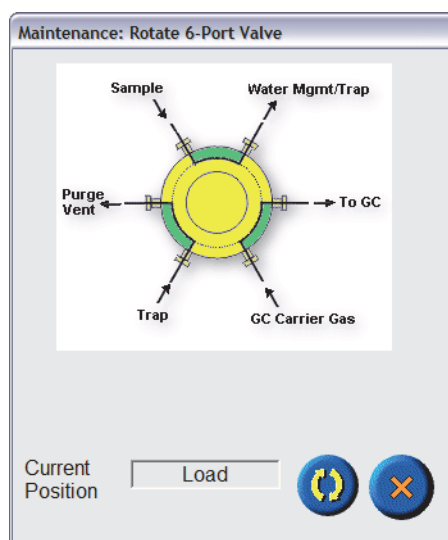

Figure 6.33. 6-Port Valve in the “Load” Position

3. Disconnect the P&T transfer line from the GC injection port.

NOTE: Be sure that the GC oven and inlet are both cool and that the carrier gas has been turned off. Follow the GC manufacturer's instructions.

4. Turn off the power to the P&T and unplug the power cord. Allow the system to cool.
5. Using the 3/8" wrench, remove the analytical trap and connect the rinsing tool to the outlet (trap) side of the water management fitting (see Figure 6.34).

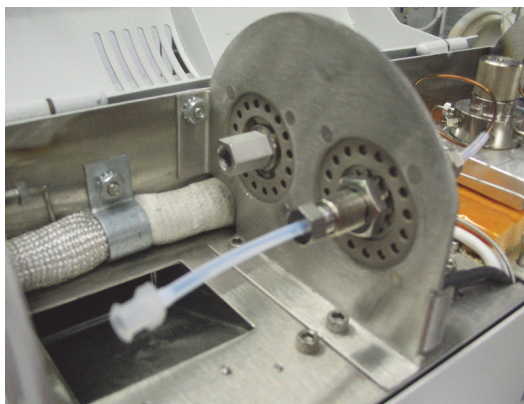

Figure 6.34. Connecting the Rinsing Tool

6. Using the rinsing tool and a syringe, rinse 10 mL of methanol through the sample pathway, collecting it in the sparge vessel (see Figure 6.35).

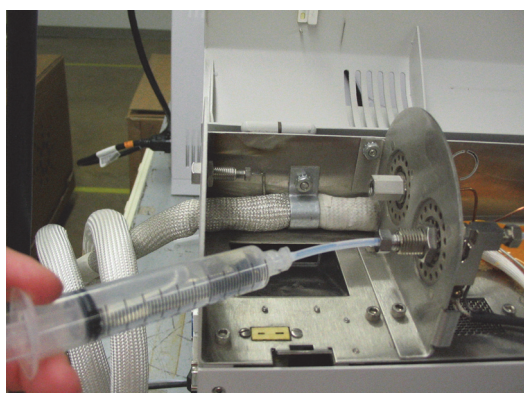

Figure 6.35. Rinsing the Sample Pathway with Methanol

7. From the 4-way valve above the sparge mount, use the syringe to remove the methanol from the sparge vessel (see Figure 6.36).



Figure 6.36. Removing the Methanol from the Sparge Vessel

8. Repeat steps 6 and 7 twice with clean aliquots of methanol.
9. Rinse 10 mL of air through the sample pathway using the syringe and the rinsing tool. Repeat twice.
10. Disconnect the rinsing tool from the water management fitting and install a Blank trap (#0, no packing material).
11. Connect the P&T power cable and turn the instrument on. Verify that the purge gas supply is on.
12. From the 4-way valve above the sparge mount, use the syringe to add 5 mL (or 25 mL) of clean reagent-grade water to the sparge vessel.
13. From the Maintenance screen, run the Purge/Bake procedure through 2 cycles to remove any remaining methanol from the system (refer to Figure 6.37).

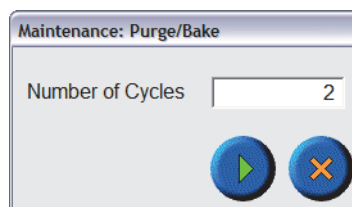

Figure 6.37. Setting the Number of Purge/Bake Cycles

14. Install a new analytical trap and condition it for 30 minutes at the recommended temperature (refer to the trap installation instructions, document part number 287250, provided with the trap).
15. Re-connect the transfer line to the GC inlet and turn the carrier gas back on.

16. Perform the automated Leak Test procedure and confirm that the P&T system is leak free.
17. Run a normal system blank with water and Internal/Surrogate standards.

Rinsing the Eclipse Transfer Line

1. From the Maintenance screen, step the instrument to either the “Standby” or “Purge Ready” state (see Figure 6.38).

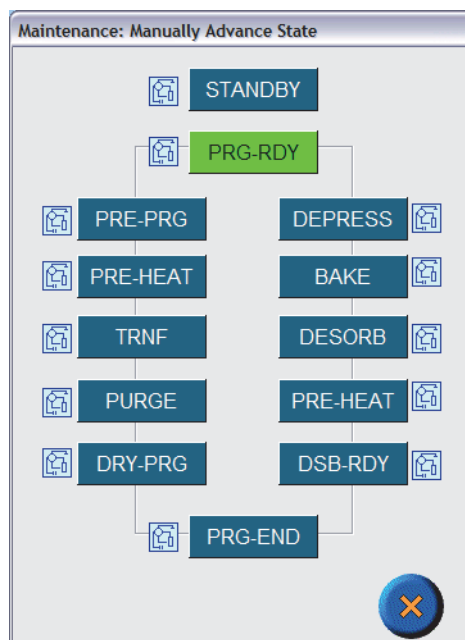

Figure 6.38. Instrument in “Purge-Ready”

2. Rotate the 6-port valve to the “Inject” position (see Figure 6.39).

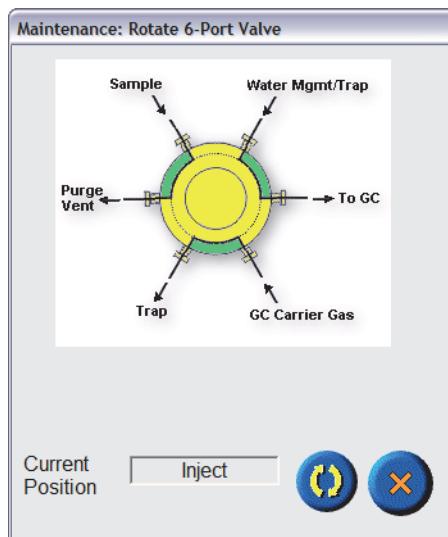

Figure 6.39. 6-Port Valve in the “Inject” Position

3. Disconnect the P&T transfer line from the GC injection port. Place the end of the transfer line in a beaker to catch the rinsate.

NOTE: Be sure that the GC oven and inlet are both cool and that the carrier gas has been turned off. Follow the GC manufacturer’s instructions.

4. Turn off the power and unplug the power cord. Allow the system to cool.
5. Using the 3/8" wrench, remove the analytical trap and connect the rinsing tool to the outlet (trap) side of the water management fitting (refer to Figure 6.40).

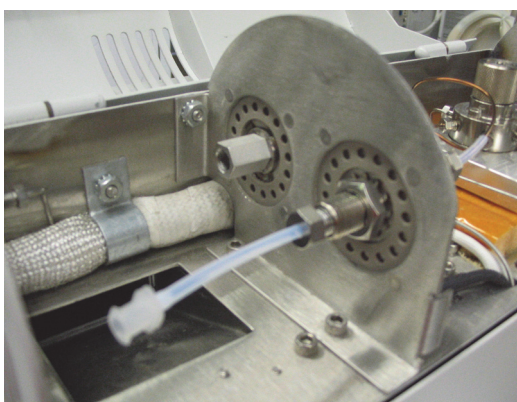

Figure 6.40. Connecting the Rinsing Tool

- Using the rinsing tool and the syringe, rinse 10 mL of methanol through the transfer line (see Figure 6.41). Repeat twice more with clean aliquots of methanol.

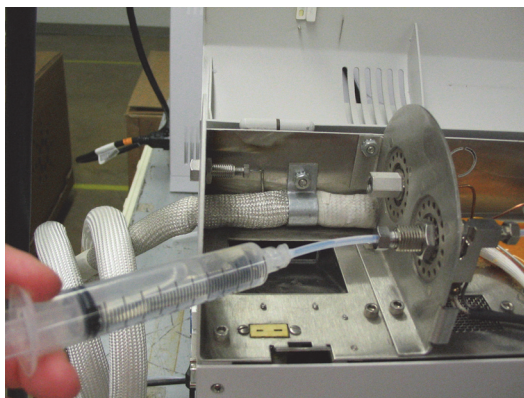

Figure 6.41. Rinsing the Sample Pathway with Methanol

- Using the rinsing tool and the syringe, rinse 10 mL of air through the transfer line. Repeat until no methanol is visible exiting the transfer line.
- Remove the rinsing tool and re-install the analytical trap (refer to the trap installation instructions, document part number 287250, provided with the trap).
- Connect the power cable and turn the instrument on.

CAUTION

Do NOT reconnect the transfer line to the GC injection port.

- From the Maintenance screen, select Trap Condition and condition the trap for 30 minutes to allow the entire system to bake and remove any remaining traces of methanol (refer to Figure 6.42).

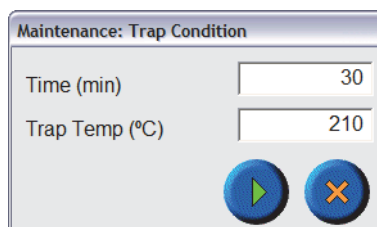

Figure 6.42. Conditioning the #10 Trap

- Re-connect the transfer line to the GC inlet and turn the carrier gas back on.
- Perform the automated Leak Test procedure and confirm that the P&T system is leak free.
- Run a normal system blank with water and Internal/Surrogate standards.

Figure 6.43.



Chapter 7 *pHDetect*[™] Module

This chapter details the following information about the *pHDetect* module:

- Introduction (on page 134)
- Instrument Components (on page 137)
- Installation (on page 139)
- Operation (on page 144)
- pH Settings (on page 145)
- Collection and Reporting of pH Data (on page 149)
- Replacement Parts (on page 154)
- Assembly Diagrams (on page 156)
- Flow Diagrams (on page 158)

Introduction

The *pHDetect* is an optional, external module for the Eclipse Purge-and-Trap (P&T) Sample Concentrator that automates pH measurement and recording for all VOC water samples.

Many USEPA methods for Volatile Organic Compounds (VOCs) require sample preservation with acid to a pH < 2, and other methods allow optional preservation techniques to pH > 11. When following these methods, replicate samples must be collected in the field solely for measuring the pH. Without the *pHDetect* module, the analyst opens the extra sample vial, measures the pH manually, and records the measurement in a log, a time-consuming and labor-intensive procedure. Alternatively, the bench chemist manually checks every vial's pH after the purge-and-trap analysis is complete. The *pHDetect* unit eliminates the need for collecting additional samples, as well as the labor and materials associated with manual pH measurement.

Operating Principles

As the water sample drains from the Eclipse sparge vessel, it is collected in a glass reservoir on the front panel of the *pHDetect* module where a precise pH electrode takes the pH reading. The pH reading is logged with a date/time stamp in the Eclipse database, and the sample drains from the reservoir. The Eclipse then prepares the sample pathway for the next sample by purging with gas and flushing with Autosampler rinse water during the normal Eclipse rinse cycle.

Calibration of the pH electrode is done at user-programmable intervals and is fully automated using the two onboard buffer solutions. Any combination of two buffer

solutions can be used (4.01 and 7.00, 7.00 and 10.00, or 4.01 and 10.00). All calibrations and sample pH measurements are logged in the Eclipse database with a date/time stamp and can be accessed from a networked PC for reporting using the Eclipse Reporter or for exporting to a spreadsheet/LAN/LIMS.

Features

- Automatically measure, record, and electronically log a pH measurement for every water sample immediately following the Purge step.
- Automatic 2-point calibration at programmable intervals.
- Log all calibrations and sample pH measurements with a date/time stamp.
- Report data from a PC using Eclipse Reporter or export data to a spreadsheet, LAN, or LIMS.
- Color-coded lines and fittings for rapid, simple installation.
- Sample pathway of glass and Teflon® materials to minimize carryover.
- Glass reservoir for visual confirmation of drain and fill functions.

Specifications

General Specifications

Dimensions. 29 cm H x 12.8 cm W x 38 cm D (11.4" H x 5" W x 14.9" D)

Weight. 3.7 kg (8.2 lbs) with both buffers loaded

Performance Specifications

pH Range. pH 0 to pH 14

Precision. ± 0.1 pH units on replicate samples

Buffer Requirements

- 4.01 and 7.00 (supplied in the startup kit),
- 7.00 and 10.00, or
- 4.01 and 10.00

Communications

- I²C connection to Eclipse
- Eclipse connection to PC or LAN for reporting

Safety Information The pHDetect has been designed and tested in accord with recognized safety standards and designed for indoor use. Using the instrument in a manner not specified by the manufacturer may impair the instrument's safety protection. If the pHDetect safety protection is compromised, disconnect the instrument from all power sources and secure the instrument against unintended operation.

General Precautions

- Replace or repair faulty or frayed insulation on power cords.
- Arrange drain lines so they can not become kinked, punctured, or otherwise damaged and will not interfere with walkways.
- Wear safety glasses to prevent possible eye injury.
- Do not perform unauthorized modifications or substitute parts that are not OI Analytical original parts to the instrument. Any unauthorized modifications or substitutions voids the warranty.

Safety Symbols

The following symbols may be located on the instrument:



Warning/Caution, see accompanying instruction for more information.



Indicates a hot surface.



Indicates hazardous voltages.



Indicates earth (ground) terminal.

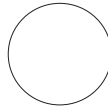

Indicates the OFF position on the power switch.



Indicates the ON position on the power switch.

Instrument Components

pHDetect Front Components

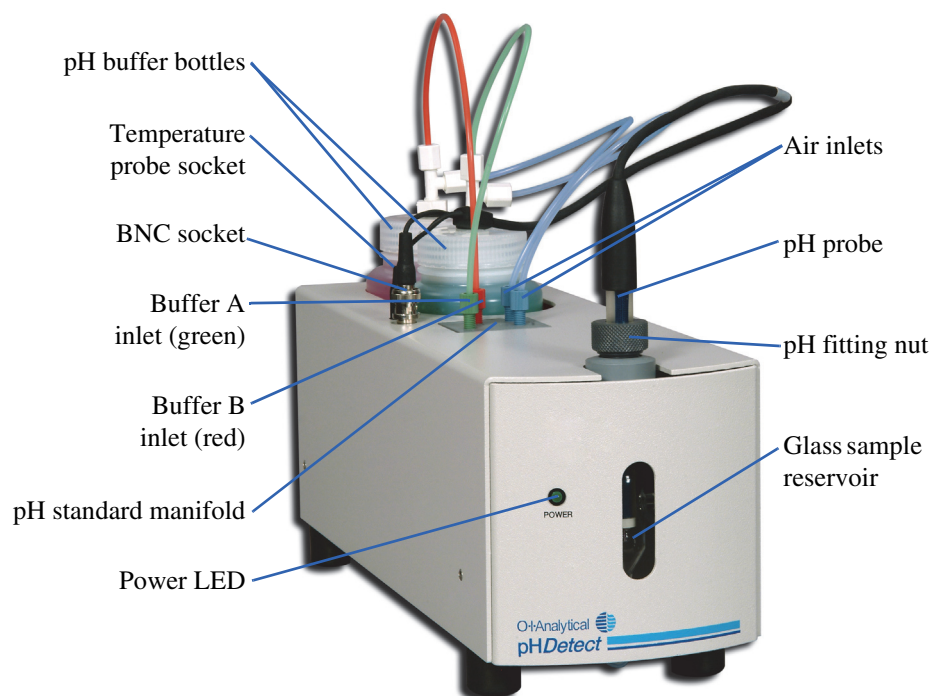

Figure 7.1. pHDetect module front view

Air inlets (two inlets) connect the pH standard bottles to the pH standard manifold. Air pressure provided by the pHDetect pump moves pH standard from the bottle into the sample cell and out through the sample outlet.

BNC socket connects the pH electrode's BNC connector to the pHDetect module.

Buffer A inlet introduces pH buffer A into the standard manifold.

Buffer B inlet introduces pH buffer B into the standard manifold.

Emergency drain (located underneath the pHDetect module back) provides an outlet for liquid in case of internal flooding.

Glass sample reservoir visually confirms the fill and drain functions.

pH buffer bottles contain the pH buffers used to calibrate the pH electrode.

pH probe measures the sample pH.

pH standard manifold connects and controls pH standard and flow to the measurement cell.

Power LED indicates the power status.

Temperature probe socket connects the pH electrode's temperature probe to the pHDetect module.

pHDetect Back Panel

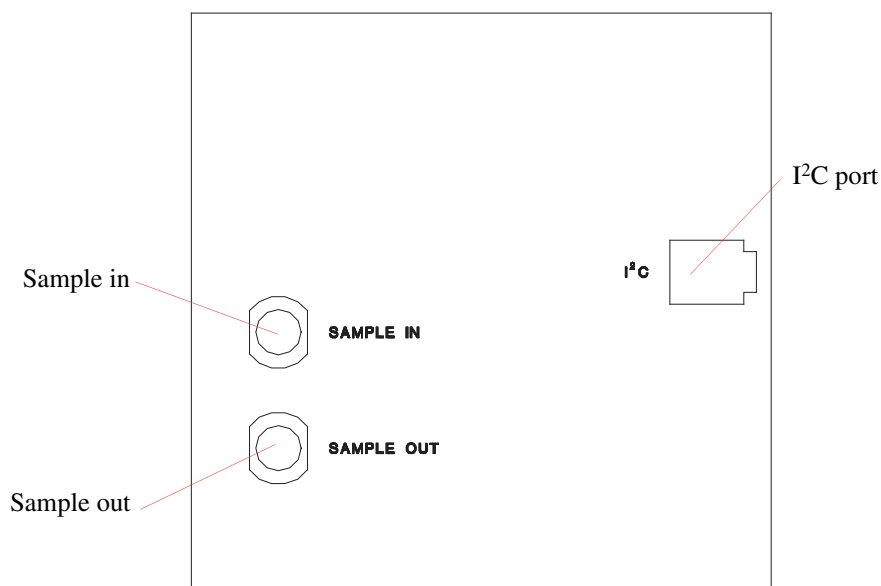

Figure 7.2. pHDetect module back panel

I²C port (four-pin connector) connects the pHDetect module to the Eclipse's I²C connector, allowing the Eclipse to control the pHDetect module.

Sample in port connects the Eclipse's Q/i" Teflon® drain line to the pHDetect module and introduces sample into the measurement cell.

Sample out port connects a drain line from the pHDetect module to a waste receptacle, sending sample and pH standard to waste.

Unpacking and Positioning the pHDetect Module

Unpack the instrument(s) and check the items against the packing list. Verify all kits are complete using the supplied component lists. If any components are missing, contact OI Analytical Customer Service at (800) 336-1911 or (979) 690-1711.

NOTE: Some items on the component list may already be installed.

If any equipment appears to be damaged, notify the carrier immediately. Save all packing materials until after verifying proper operation of all components.

NOTE: Ship all instruments returned to OI Analytical for service or warranty repair with a return material authorization (RMA) number and in the original OI Analytical box with its packing materials. If instruments are damaged due to improper shipping, OI Analytical is not be responsible for the repair costs. Obtain the RMA number from the OI Analytical Customer Support Center at (800) 336-1911 or (979) 690-1711. If proper shipping materials are needed, contact OI Analytical Order Entry at (800) 336-1911 or (979) 690-1711.

1. Remove the pHDetect module from the shipping carton.
2. Place the pHDetect module beside the Eclipse, allowing adequate space for the drain line.

Installation

This section describes the basic installation procedure for the pHDetect module. Failure to complete all sections of this procedure may result in incomplete installation and improper operation.

1. Verify the Eclipse PC software and instrument software are version 2.1. If the version is earlier than 2.1, upgrade the software using the upgrade kit, part number 322469.
 - To find the PC software version, go to Start → Program Files → OI Analytical, and open the Readme file. The latest version is indicated by **v2.1** in the sentence: “This is **v2.1** of OI Analytical's Eclipse 4660 software.”
 - The instrument software revision is located in the Maintenance screen under the Information icon as **060512A MTINov03**.
2. Turn off the Eclipse and unplug the unit.
3. Connect one end of the pHDetect cable (PN 321487, provided in the pHDetect startup kit) to the I²C port on the back of the Eclipse (see Figure 2.2 for the I²C Eclipse port location).
4. Connect the other end of the pHDetect cable to the I²C port on the back of the pHDetect (see Figure 7.2 for the I²C pHDetect port location).
5. Cut the Eclipse drain line so it is just long enough to reach the pHDetect Sample In port (approximately 2–3' from the back of the Eclipse).
6. Connect the Eclipse drain line to the pHDetect Sample In port using a nut (PN 263764) and ferrule (PN 263756) provided in the pHDetect startup kit.
7. Cut a length of Teflon® tubing (PN 147901, provided in the pHDetect startup kit) long enough to connect the pHDetect to a waste receptacle.

8. Attach one end of the tubing to the pHDetect Sample Out port using a nut (PN 263764) and ferrule (PN 263756) from the pHDetect startup kit.
9. Place the other end of the tubing into a waste receptacle.
10. Fill the pH buffer bottles (see Figure 7.1 for the location of the buffer bottles) with the appropriate buffer solutions as described below:

NOTE: When analyzing samples that have been preserved in the acidic range, calibrate the pHDetect module with pH 7.00 (buffer A) and pH 4.01 (buffer B) standard buffers. For samples preserved in the basic range, calibrate with pH 7.00 (buffer A) and pH 10.00 (buffer B) standard buffers.

- a. Fill a buffer bottle with buffer A (pH 7.00) standard buffer.
 - b. Install the bottle top attached to the green Teflon® line, which connects to the buffer A inlet on the pH select manifold.
 - c. Place this bottle in the pHDetect bottle holder.
 - d. Fill the second buffer bottle with buffer B (pH 4.01 or 10.00) standard buffer.
 - e. Install the bottle top attached to the red Teflon® line, which connects to the buffer B inlet on the pH buffer select manifold.
 - f. Place this bottle in the pHDetect bottle holder.
11. Install the pH probe into the glass pH reservoir:

CAUTION

The glass pH electrode on the tip of the pH probe is extremely fragile; take care not to damage it.

- a. Carefully remove the pH probe from the storage solution. Save the solution and storage bottle for future use. Use ParaFilm® or a similar wrap to cover the storage solution to prevent evaporation.
- b. Loosen and remove the pH fitting nut from the pH manifold cap (refer to Figure 7.1 for the pH manifold cap location).
- c. If the Teflon® ferrule is in place, remove the ferrule from the manifold.
- d. Slide the pH fitting nut onto the pH probe.
- e. Slide the Teflon® ferrule onto the pH probe.
- f. Insert the pH probe into the reservoir, being careful not to break the small glass pH electrode. Position the probe such that the probe cable is approximately 15–20 mm above the top of the pH fitting nut (refer to Figure 7.3).

NOTE: Position the pH electrode and RTD inside the glass reservoir above the “V”-shaped neck; verify the probe is not touching any inside surfaces.

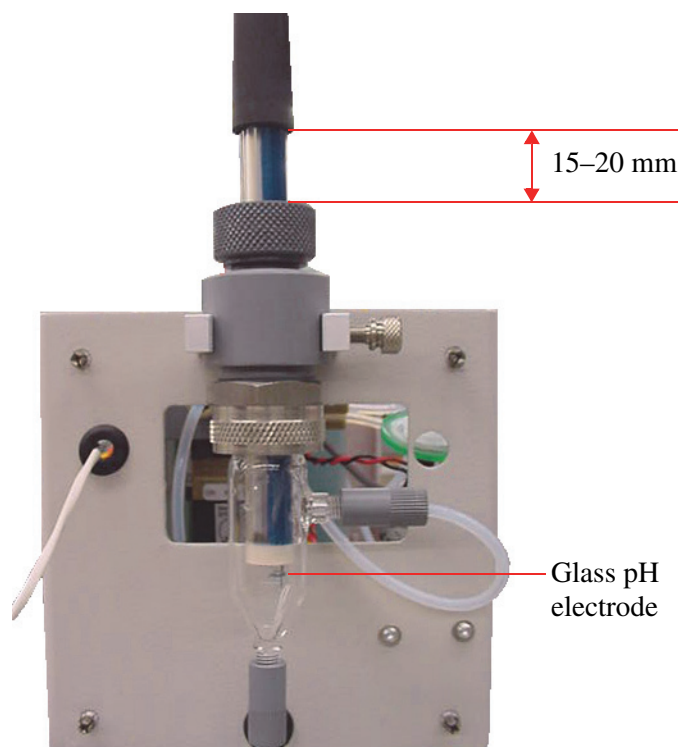

Figure 7.3. pH probe installation

- g. Finger-tighten the pH fitting nut.
- h. Pull up on the pH probe to verify the fitting and ferrule have sealed against the probe. Re-tighten if necessary.

NOTE: The probe may rock slightly or shift up somewhat with a strong pull. Be sure to reposition the probe if it moves.

12. Plug the pH probe's BNC connector into the BNC socket of the pHDetect located on the top of the unit (refer to Figure 7.1 for the BNC socket location).
13. Plug the pH probe's temperature sensor into the temperature sensor socket located on the top of the pHDetect.

Configuring the pHDetect

This section describes configuring the Eclipse software for proper operation with the pHDetect.

Enabling the pHDetect in the Eclipse software

1. Plug in the Eclipse power cord.
2. Turn on the power and log into the Eclipse software.

3. Press the **Config** icon to access the General configuration screen. Modify an existing configuration or create a new configuration (see Chapter 5, “Configuring the Eclipse” on page 87).
4. From the Configure screen, press the **Options** tab to access the Options Configure screen (see Figure 7.4).

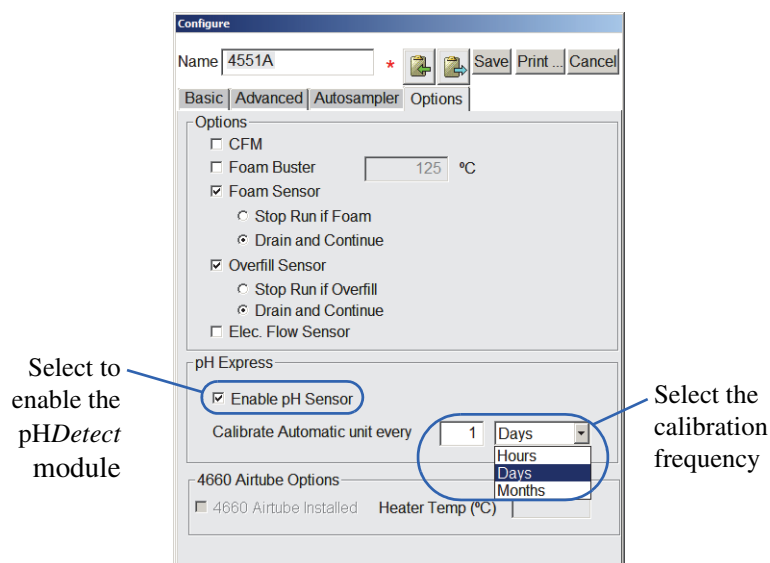

Figure 7.4. Enabling the pHDetect module

5. Select the checkbox beside **Enable pH Sensor**.
6. Set the calibration frequency using the on-screen keyboard. See “Calibrating the pHDetect Module” on page 145 for more information on calibration.
7. Save the configuration by pressing **Save**.
8. To make the configuration active, press and highlight its named icon and press **Make Active**.

Enabling pH Measurement in the Method(s)

1. Access the Method Editor screen by touching the **Method** tab from the **Editor** icon. Modify an existing method or create a new method (see Chapter 4, “Method Editor Screen” on page 58 for more information).
2. Select the checkbox for **Record Sample pH** to enable pH measurement (see Figure 7.5).

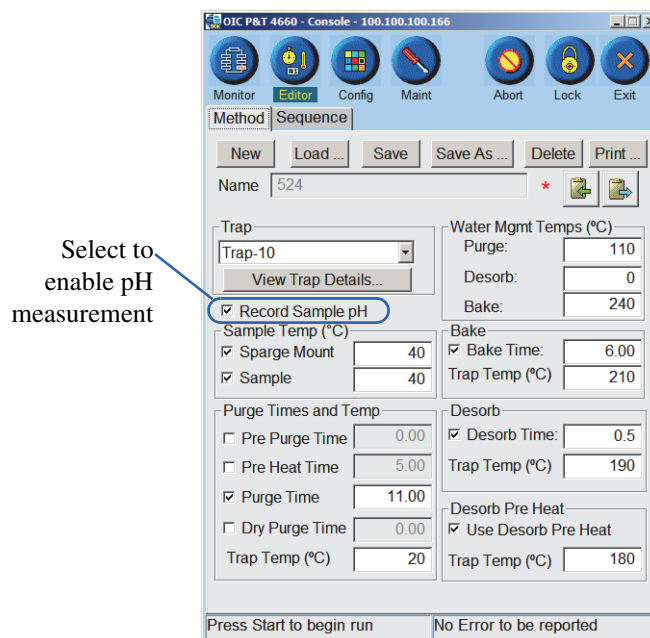

Figure 7.5. Enabling pH measurement in a method

NOTE: The pH must be enabled in both the Active Config and the Active Method in order for pH readings to be recorded in the log.

3. Set the log file to record the pH measurements:

- a. Press the **Maint** icon to access the Maintenance screen. Press **Instrument Log** to access the Maintenance: Instrument Log dialog box.
- b. Press **Log Maintenance** to access the Log Maintenance dialog box (refer to Figure 7.6).
- c. Set the value of **PH Reading** to the maximum of 200 to encompass the number of samples to be run (the value ranges from 0 to 200); refer to Figure 7.6.

CAUTION:

If the number of pH readings is set too low, pH data may be lost.

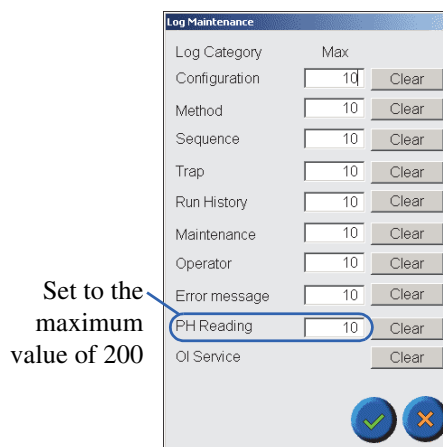

Figure 7.6. Log Maintenance dialog box

Configuring the Model 4552 Autosampler

If using a Model 4552 Water/Soil Autosampler, set the Desorb Time setting in the 4552 method to 0.0 minutes. Failure to do so may result in insufficient sample volume entering the pHDetect module. Programming the 4552 in this manner causes most of the sample to drain through the 4660 to the pHDetect module, limiting the amount of sample draining through the 4552.

Operation

This section provides operating information for the pHDetect module.

pHDetect Module Operation

1. During the PURGE state, the pHDetect module drains the glass pH sample reservoir to remove all buffer or rinse water.
2. If the pHDetect module is configured to automatically calibrate, the Eclipse will determine if the pH electrode is scheduled for calibration and will tell the pHDetect module to calibrate during the PURGE state.

NOTE: The calibration takes approximately 7 minutes. If the instrument is set to automatically calibrate, ensure the PURGE state is at least 7 minutes long.

3. During the DESORB state, the sample drains through the Eclipse drain line and flows into the pHDetect sample reservoir.
4. The pHDetect module lets the pH sample stabilize for approximately 1 minute and reports a reading to the Eclipse, which is recorded in the pH log file with a time and date stamp.
5. After the reading is taken, the pHDetect unit again drains the pH sample reservoir.
6. If the 4551A Autosampler is programmed for rinses (as recommended), the rinses drain from the Eclipse and through the pHDetect reservoir, rinsing the pH sample pathway.

NOTE: With the 4552 Autosampler, the Eclipse drain line does not get swept and may result in some carryover.

pH Settings

The Maintenance screen contains diagnostic and maintenance tools for the pHDetect module (Figure 7.7).

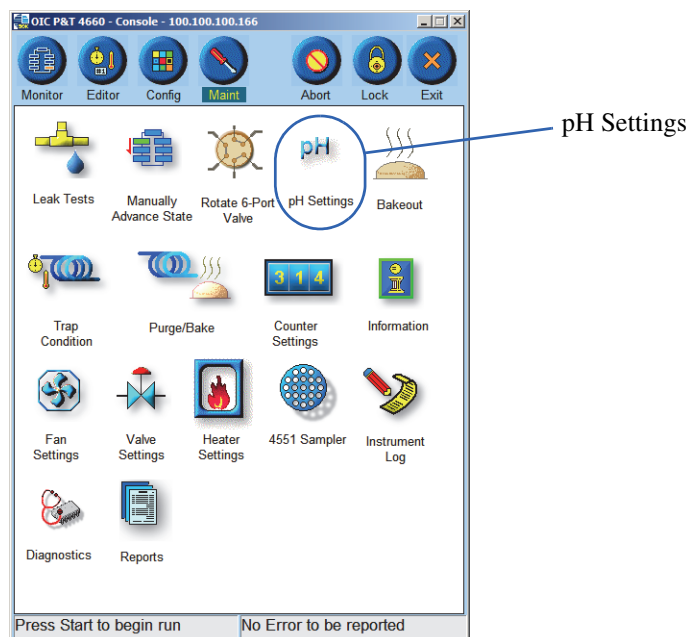

Figure 7.7. Maintenance screen

Calibrating the pHDetect Module

The Maintenance: pH Settings dialog box contains pHDetect maintenance features, such as calibrating the electrode and loading pH buffer.

Program the pHDetect unit for calibration at specified time intervals by referring to “Configuring the pHDetect” on page 141 or initiate automatic calibration of the pH probe any time when the Eclipse is in the Standby state using the following steps:

1. Press the **pH Settings** icon from the Maintenance screen (see Figure 7.7) to access the Maintenance: pH Settings dialog box as shown in Figure 7.8.

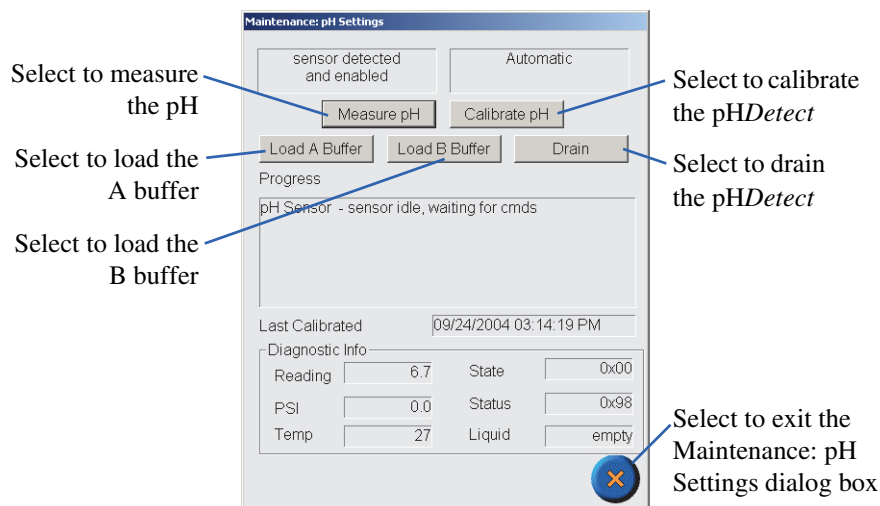

Figure 7.8. Maintenance: pH Settings dialog box

NOTE: When analyzing samples that have been preserved in the acidic range, calibrate the pHDetect module with pH 7.00 (buffer A) and pH 4.01 (buffer B) standard buffers. For samples preserved in the basic range, calibrate with pH 7.00 (buffer A) and pH 10.00 (buffer B) standard buffers.

2. Verify buffer bottles are in place and have buffer solution.
3. Press **Calibrate pH**.
4. The instrument automatically calibrates using the pH buffer solutions; this process takes approximately seven minutes.

A new calibration log entry appears in the Eclipse Instrument Log to indicate a valid calibration. An error message on the pH display or in the instrument log indicates an unsuccessful calibration.

Calibration Operation

Whether during the PURGE state or by pressing the **Calibrate pH** button in the Maintenance screen, the calibration operates as follows:

1. The pHDetect module drains the pH sample reservoir.
2. The pHDetect module loads the pH sample reservoir with Buffer A, drains, and repeats the load and drain of Buffer A for adequate rinsing of the probe and sample lines.
3. The pHDetect module loads the pH sample reservoir with Buffer A a third time, takes the pH reading (approximately 1 minute), and drains Buffer A.
4. The pHDetect module loads and drains Buffer B twice.

5. The pHDetect module loads Buffer B a third time, takes the pH reading, and drains the pH reservoir.
6. If the calibration was successful, the new calibration coefficients will be written in the pH firmware, and the Eclipse will log a “calibration successful” message to the Instrument Log.
7. If an error occurs at any point during calibration, the calibration routine stops and an error message is written to the log.

Automatically Calibrate during PURGE

To automatically calibrate during the PURGE state, set the appropriate calibration frequency of “Calibrate Automatic unit every” in the Configure dialog box (see Figure 7.4).

Prevent Automatic Calibration during PURGE

To prevent the pHDetect module from automatically calibrating during the PURGE state, set the frequency of “Calibrate Automatic unit” to every 12 months (or any long period of time); calibrate before the beginning of each sequence by pressing the **Calibrate pH** button in the Maintenance: pH Settings dialog box (see Figure 7.8).

NOTE: Due to the possibility of calibration buffer left in the reservoir affecting the next sample’s pH reading, calibrate prior to each sequence and run a blank or standard as the first sample.

Maintenance

This section provides maintenance information for the pHDetect module.

Exterior Maintenance

Wipe exterior surfaces with a lint-free, nonabrasive cloth to remove loose dust. Do not use abrasive cleaners. Wipe up any spills immediately with a soft cloth dampened with water. Wipe dry with a soft cloth. Neutralize corrosive spills immediately with an appropriate compound.

Storing the pH Probe

For short periods of time (between half a day and three days), store the pH probe in the glass reservoir in 4.01 buffer solution.

1. Access the Maintenance: pH Settings dialog box.
2. Press the **Load B Buffer** button.
3. The pHDetect module loads Buffer B (pH 4.01) into the pH glass reservoir.

If the pHDetect module will be sitting idle for more than 3 days, store the pH probe in the storage solution provided with the probe in the startup kit.

1. Remove the wrap/cover from the pH storage solution bottle.
2. Slightly loosen the cap with O-ring to prepare for installation of the pH probe.
3. Disconnect the probe cables from the pHDetect PCA connectors.
4. Loosen the fitting nut at the top of the pH reservoir. Carefully remove the pH probe from the pH reservoir, being careful not to break the glass pH electrode at the tip of the probe.
5. Carefully insert the end of the pH probe into the storage solution bottle. Do not push the probe to the bottom of the bottle. Gently allow the tip of the pH probe to touch the sponge inside the storage bottle.
6. Tighten the cap with O-ring to seal. Store the bottle upright.

CAUTION

The glass pH electrode is extremely fragile; take care not to damage it.

Cleaning the pH Probe

If oil or grease coat the probe, gently wash it with a mild dishwashing detergent. Rinse thoroughly with reagent water. Soak the probe for 30 minutes in pH probe storage solution. Recalibrate the probe before use.

CAUTION:

Do not use strong solvent (e.g., acetone, carbon tetrachloride, etc.) to clean the pH probe.

If protein or similar materials coat the probe, soak it in an acidic pepsin solution for five minutes. Rinse thoroughly with reagent water. Recalibrate before use.

If the previous cleaning procedures fail to restore the probe's response, soak it in 0.1 N hydrochloric acid for 30 minutes. Rinse thoroughly with reagent water. Recalibrate before use.

Cleaning the Glass Reservoir

Replace or clean the glass reservoir periodically or if it becomes dirty and the sample does not drain completely and smoothly.

1. Remove the pH electrode and store it as described in "Storing the pH Probe" on page 147.
2. Loosen and remove the 4 fittings from the top of the pH Buffer Select manifold.
3. Remove the pH top cover.
4. Remove the pH front cover:
 - a. Holding the bottom edge of the cover, pull out and away so the cover pops loose from the two bottom PEM® nut that are attached to the chassis.
 - b. Hold the cover closer to the top two PEM studs and pull.

5. To aid in disassembly, loosen the thumbscrew holding the pH manifold cap and remove the reservoir assembly.
6. Remove the three threaded fittings on the fill and drain lines.
7. Loosen the 18-mm nut holding the glass reservoir in place.
8. Carefully, slide the reservoir down and away from the manifold.
9. Sonicate the glass reservoir in mild soapy water for 10–15 minutes. Use a soft brush to clean the inside, if necessary.
10. Thoroughly rinse the reservoir with tap water and DI water; any residual soap residue will affect subsequent pH readings. If the glass reservoir cannot be cleaned so that water “sheets” cleanly down the sides, it should be replaced.
11. Re-install the glass reservoir into the manifold using a new 18-mm ferrule; tighten with a wrench.
12. Finger-tighten the knurled fittings on the fill and drain lines.
13. Slide the reservoir assembly into the bracket and tighten the thumbscrew.
14. Re-install the probe according to step 11 on page 140.
15. Fill with buffer and check for leaks.
16. Re-install the front and top covers.
17. Re-attach all lines.

Collection and Reporting of pH Data

This section provides information for reporting pH data using the pHDetect module and the Eclipse Reporter.

Importing pH Reports

1. Connect to the Eclipse using the PC software by right-clicking the Device icon in the Eclipse LaunchPad and selecting **Connect to Eclipse** or by double-clicking the device icon.
2. Press the **Maint** icon to access the Maintenance screen.
3. Press **Instrument Log** to access the Maintenance: Instrument Log dialog box as shown in Figure 7.9.

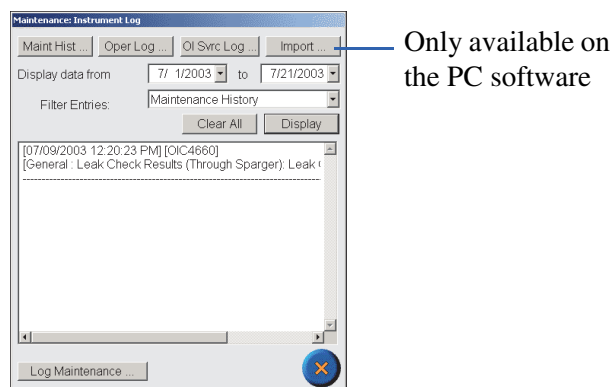

Figure 7.9. Maintenance: Instrument Log dialog box

4. Select **Import** to access the Import Data dialog box (refer to Figure 7.10).

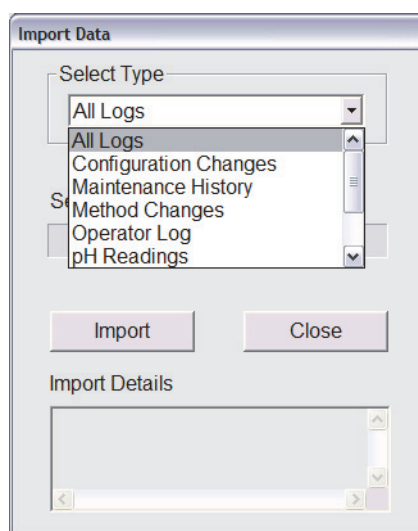

Figure 7.10. Import Data dialog box

5. Under **Select Type**, select “pH Readings” or “All Logs”, and press **Import**.

NOTE: Depending upon the number of logs being imported and the number of file entries in each log, this operation may take several minutes.

6. Press **Close** to exit the dialog box once importing the data is complete.

View/Print pH Reports

1. Connect to the Eclipse using the PC software by right-clicking the Device icon in the Eclipse LaunchPad and selecting **Connect to Eclipse** or by double-clicking the **Device** icon.
2. Press the **Maint** icon to access the Maintenance screen.
3. From the Maint screen, select **Reports**; alternatively, right click on the device icon in the Eclipse LaunchPad to access Eclipse Reporter as shown in Figure 7.11.



Figure 7.11. Right-click the Device to access the Eclipse Reporter

4. Select the **Start Date and Time** and **End Date and Time** to define the report (see Figure 7.12).

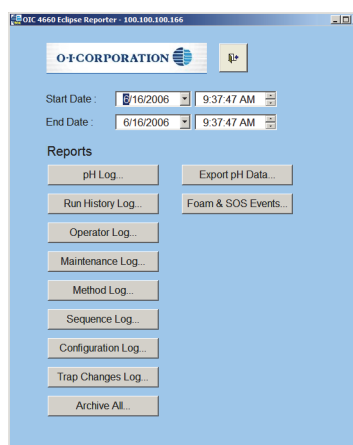

Figure 7.12. Eclipse Reporter Reports screen

5. Select the report type to view and/or print by clicking the appropriate button; an example of a pH Log report is shown in Figure 7.13.

OI Analytical 4660			
PH Readings			
Date/Time of Entry	User ID	Log Entry Details	
5/16/2006 2:10:15PM	OIC4660	vial pos 3, pH = 4.6, last cal 05/16/2006	(pos-> pos Rtion)
5/16/2006 2:31:15PM	OIC4660	vial pos 4, pH = 4.6, last cal 05/16/2006	(pos-> pos Rtion)
5/16/2006 2:52:09PM	OIC4660	vial pos 5, pH = 4.7, last cal 05/16/2006	(pos-> pos Rtion)
5/16/2006 3:13:03PM	OIC4660	vial pos 6, pH = 4.6, last cal 05/16/2006	(pos-> pos Rtion)
5/16/2006 3:34:22PM	OIC4660	vial pos 7, pH = 4.6, last cal 05/16/2006	(pos-> pos Rtion)
5/16/2006 3:55:18PM	OIC4660	vial pos 8, pH = 4.1, last cal 05/16/2006	(pos-> pos Rtion)
5/16/2006 4:16:09PM	OIC4660	vial pos 9, pH = 2.7, last cal 05/16/2006	(pos-> pos Rtion)
5/16/2006 4:37:07PM	OIC4660	vial pos 10, pH = 2.7, last cal 05/16/2006	(pos-> pos Rtion)
5/16/2006 4:57:35PM	OIC4660	vial pos 11, pH = 2.7, last cal 05/16/2006	(pos-> pos Rtion)
5/16/2006 5:18:29PM	OIC4660	vial pos 12, pH = 2.7, last cal 05/16/2006	(pos-> pos Rtion)
5/16/2006 5:39:52PM	OIC4660	vial pos 13, pH = 2.7, last cal 05/16/2006	(pos-> pos Rtion)
5/16/2006 6:00:47PM	OIC4660	vial pos 14, pH = 2.7, last cal 05/16/2006	(pos-> pos Rtion)
5/16/2006 6:21:41PM	OIC4660	vial pos 15, pH = 2.7, last cal 05/16/2006	(pos-> pos Rtion)
5/16/2006 6:42:34PM	OIC4660	vial pos 16, pH = 2.7, last cal 05/16/2006	(pos-> pos Rtion)
5/16/2006 7:03:28PM	OIC4660	vial pos 17, pH = 1.3, last cal 05/16/2006	(pos-> pos Rtion)
5/16/2006 7:24:27PM	OIC4660	vial pos 18, pH = 1.1, last cal 05/16/2006	(pos-> pos Rtion)
5/16/2006 7:45:26PM	OIC4660	vial pos 19, pH = 0.9, last cal 05/16/2006	(pos-> pos Rtion)

Figure 7.13. Example pH Log Report

6. To print the information, click the printer icon in the upper left corner of the window.

Exporting Reports

1. Connect to the Eclipse using the PC software by right-clicking the Device icon in the Eclipse LaunchPad and selecting **Connect to Eclipse** or by double-clicking the **Device** icon.
2. Press the **Maint** icon to access the Maintenance screen.
3. From the Maint screen, select **Reports**; alternatively, right click on the Device icon in the Eclipse LaunchPad to access Eclipse Reporter as shown in Figure 7.11.
4. Select the **Start Date** and **Time** and **End Date** and **Time** to define the report (see Figure 7.12).
5. Export the pH data by clicking the button labeled **Export pH Data**.
6. Complete the following Export Data options (refer to Figure 7.14):
 - a. **Output Delimiter** – Choose from Tab Delimited, Comma Delimited, or Space Delimited data.
 - b. **Directory** – Select the directory where the file will be saved.
 - c. **Append or Overwrite** – Select the appropriate radio button to append to an existing file or overwrite an existing file.
 - d. **Include Header** – Select this option to include column header labels in the export file.
 - e. **Filename** – Type a filename for the exported data.
 - f. **Append Date Time Stamp to Filename** – Select to append the current date and time stamp to the filename. For example, a filename of “stat” with the Append Date Time Stamp option selected for the date July 8, 2006 and current time of 10:20:54 AM would be named as follows:

```
stat 20060806 10-20-54 AM.txt
```
 - g. **Include Statistics** – This option is for pH data only and will add the Total Number of pH Readings and the Average pH Value to the exported data.

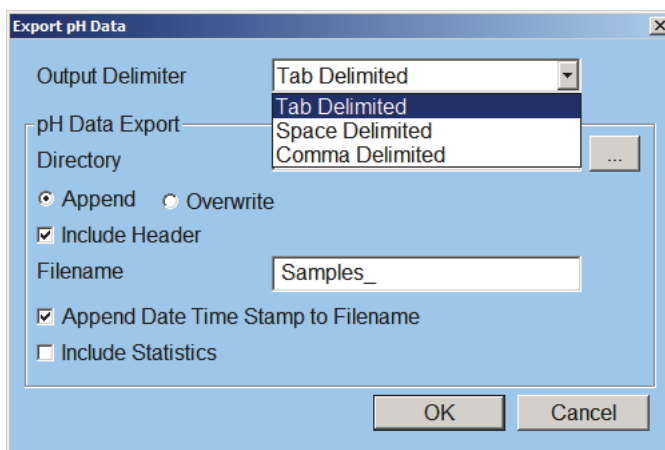

Figure 7.14. Export pH Data dialog box

7. Figure 7.15 shows an example of exported pH Data:

Date	Time	Operator ID	Vial#	Measured pH	Detail Message
05/15/2006	10:24:13	OIC4660	N/A	N/A	"pH Express auto-calibration completed"
05/15/2006	10:47:04	OIC4660	1	2.1	"vial pos 1, pH = 2.1, last cal 05/15/2006"
05/15/2006	11:08:00	OIC4660	2	2.0	"vial pos 2, pH = 2.0, last cal 05/15/2006"
05/15/2006	11:20:31	OIC4660	3	2.0	"vial pos 3, pH = 2.0, last cal 05/15/2006"
05/15/2006	11:33:25	OIC4660	4	2.0	"vial pos 4, pH = 2.0, last cal 05/15/2006"
05/15/2006	13:22:37	OIC4660	N/A	N/A	"pH Express auto-calibration completed"
05/15/2006	14:44:38	OIC4660	1	0.9	"vial pos 1, pH = 0.9, last cal 05/15/2006"
05/15/2006	15:05:30	OIC4660	2	0.9	"vial pos 2, pH = 0.9, last cal 05/15/2006"
05/15/2006	15:26:24	OIC4660	3	0.8	"vial pos 3, pH = 0.8, last cal 05/15/2006"
05/15/2006	15:47:23	OIC4660	4	0.8	"vial pos 4, pH = 0.8, last cal 05/15/2006"
05/15/2006	16:08:13	OIC4660	5	2.4	"vial pos 5, pH = 2.4, last cal 05/15/2006"
05/15/2006	16:29:12	OIC4660	6	3.0	"vial pos 6, pH = 3.0, last cal 05/15/2006"
05/15/2006	16:50:08	OIC4660	7	3.1	"vial pos 7, pH = 3.1, last cal 05/15/2006"
05/15/2006	17:11:01	OIC4660	8	3.1	"vial pos 8, pH = 3.1, last cal 05/15/2006"
05/15/2006	17:31:56	OIC4660	9	4.4	"vial pos 9, pH = 4.4, last cal 05/15/2006"
05/15/2006	17:52:48	OIC4660	10	4.7	"vial pos 10, pH = 4.7, last cal 05/15/2006"
05/15/2006	18:13:47	OIC4660	11	4.6	"vial pos 11, pH = 4.6, last cal 05/15/2006"
05/15/2006	18:34:38	OIC4660	12	4.6	"vial pos 12, pH = 4.6, last cal 05/15/2006"
05/15/2006	18:55:31	OIC4660	13	1.3	"vial pos 13, pH = 1.3, last cal 05/15/2006"
05/15/2006	19:16:24	OIC4660	14	1.0	"vial pos 14, pH = 1.0, last cal 05/15/2006"
05/15/2006	19:37:22	OIC4660	15	0.9	"vial pos 15, pH = 0.9, last cal 05/15/2006"
05/15/2006	19:58:16	OIC4660	16	0.9	"vial pos 16, pH = 0.9, last cal 05/15/2006"
05/15/2006	20:19:15	OIC4660	17	2.0	"vial pos 17, pH = 2.0, last cal 05/15/2006"
05/15/2006	20:40:09	OIC4660	18	2.7	"vial pos 18, pH = 2.7, last cal 05/15/2006"
05/15/2006	21:01:12	OIC4660	19	2.9	"vial pos 19, pH = 2.9, last cal 05/15/2006"
05/15/2006	21:22:06	OIC4660	20	3.0	"vial pos 20, pH = 3.0, last cal 05/15/2006"
05/15/2006	21:43:02	OIC4660	21	4.3	"vial pos 21, pH = 4.3, last cal 05/15/2006"
05/15/2006	22:03:56	OIC4660	22	4.6	"vial pos 22, pH = 4.6, last cal 05/15/2006"
05/15/2006	22:24:51	OIC4660	23	4.3	"vial pos 23, pH = 4.3, last cal 05/15/2006"
05/15/2006	22:45:50	OIC4660	24	4.7	"vial pos 24, pH = 4.7, last cal 05/15/2006"
05/15/2006	22:58:16	OIC4660	25	1.2	"vial pos 25, pH = 1.2, last cal 05/15/2006"

Figure 7.15. Example exported pH data

Replacement Parts

Table 7.1. pHDetect replacement parts

Product	Size	Unit	PN	XPN
Air pump assembly	—	each	321681	
Buffer solution - pH 4.01	—	bottle	108700	*
Buffer solution - pH 7.0	—	bottle	108702	*
Cap manifold	—	each	324113	
Ferrule, TFE	½"	each	324124	*
Ferrule, TFE	18 mm	each	224204	*
Fitting nut	—	each	321092	
Fitting - CPVC, reverse	Q/r-28	each	324084	*
Fitting - bulkhead PEEK	Q/r-28 x ¼-28	each	A001493	
Fitting - Nut Peek, Blue, Flangeless	Q/r-28, Q/i"	each	319345	*
Fitting - Nut Peek, Green, Flangeless	Q/r-28, Q/i"	each	319347	*
Fitting - Nut Peek, Natural, Flangeless	Q/r-28, Q/i"	each	319343	*
Fitting - Nut Peek, Red, Flangeless	Q/r-28, Q/i"	each	319344	*
Nut - knurled	18 mm	each	224675	
O-ring (EPDM replacement for Valve, PN 321908)	—	each	321925	*
PCA - Pressure Transducer	—	each	320670	
PCA - pH Detect	—	each	311257-T	
pH fill/drain manifold assembly	—	each	321162	
pH select manifold assembly	—	each	321163	
Probe - pH Detect	—	each	321685	
Reservoir - pH glass	—	each	324106	
Tubing - Silicone	Q/r" x Q/i"	foot	323584	*
Tubing - TFE, blue	Q/i" x 0.062" I.D.	foot	319607	*

Table 7.1. pHDetect replacement parts

Product	Size	Unit	PN	XPN
Tubing - TFE, green	Q/i" x 0.062" I.D.	foot	319606	*
Tubing - TFE, red	Q/i" x 0.062" I.D.	foot	319328	*
Tubing - TFE, wall	Q/i" O.D. x 0.030"	foot	147901	*
Thumbscrew - Stainless Steel	10-32 x 0.375	each	324115	*
Valve - 3-way, 12 V isolation	—	each	326129	

Assembly Diagrams

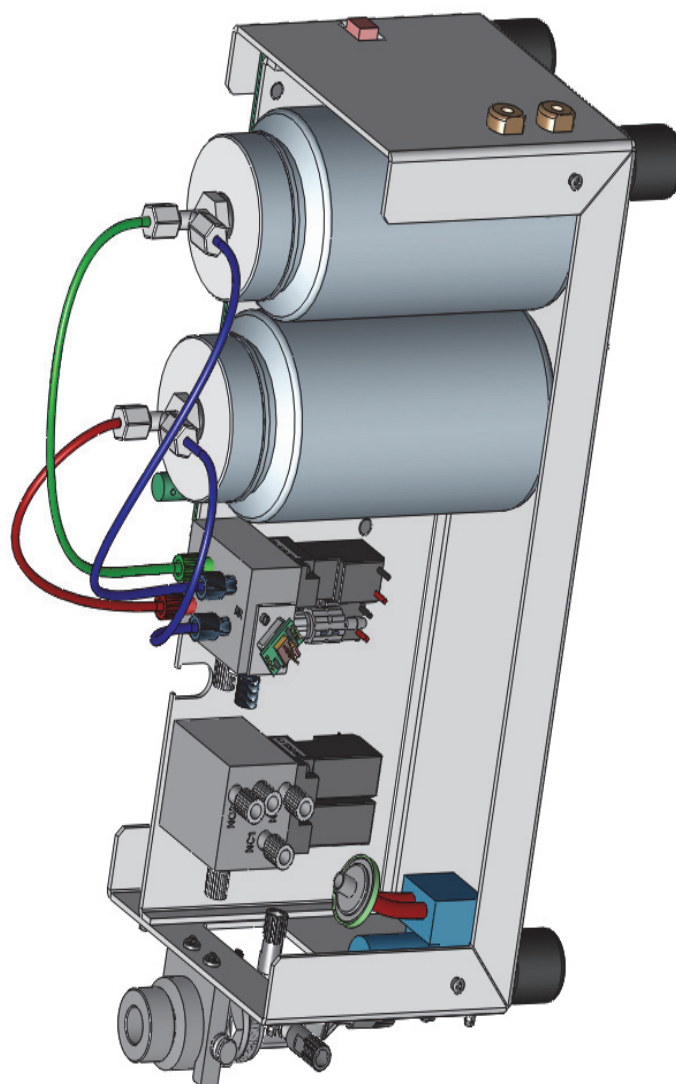

Figure 7.16. pHDetect assembly

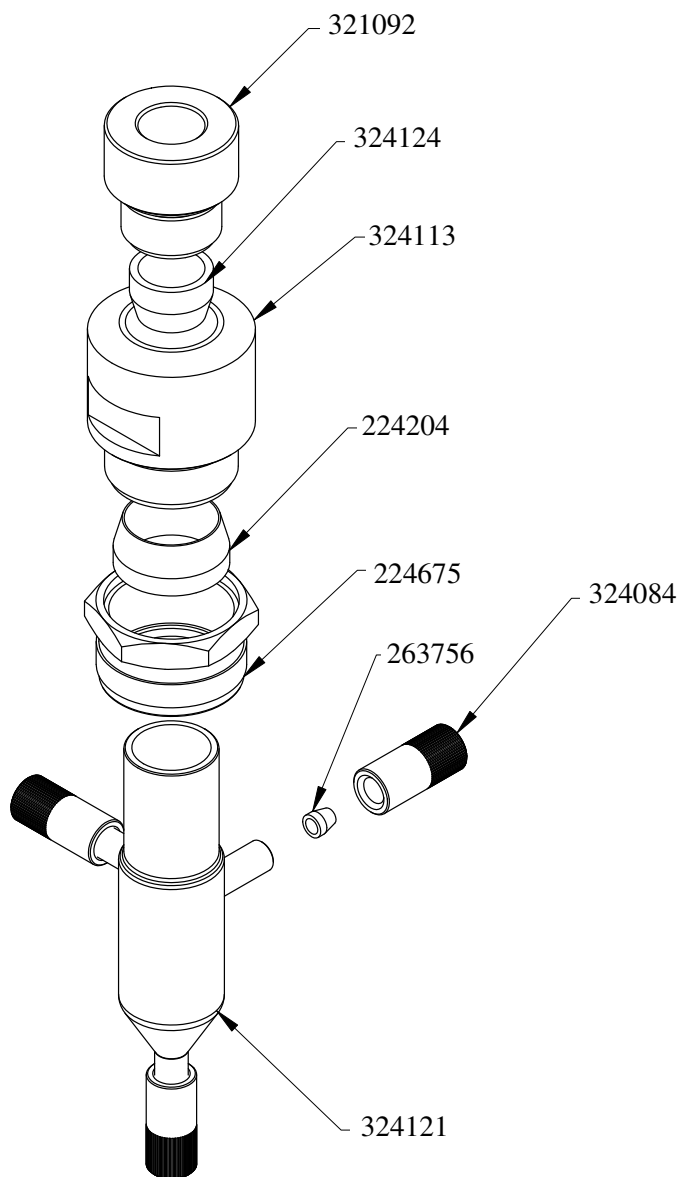

Figure 7.17. pHDetect probe assembly

Flow Diagrams

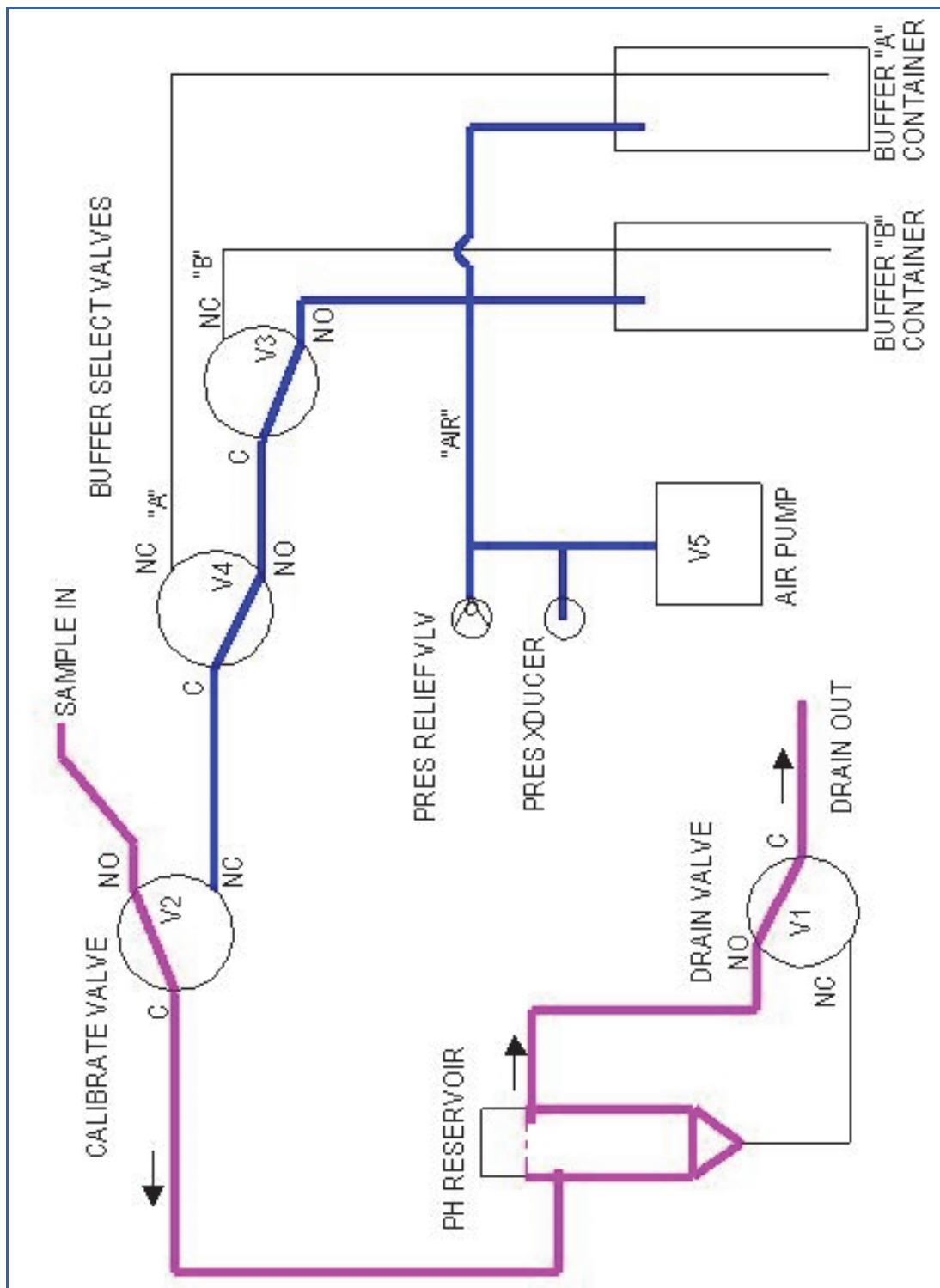

Figure 7.18. pHDetect sample fill

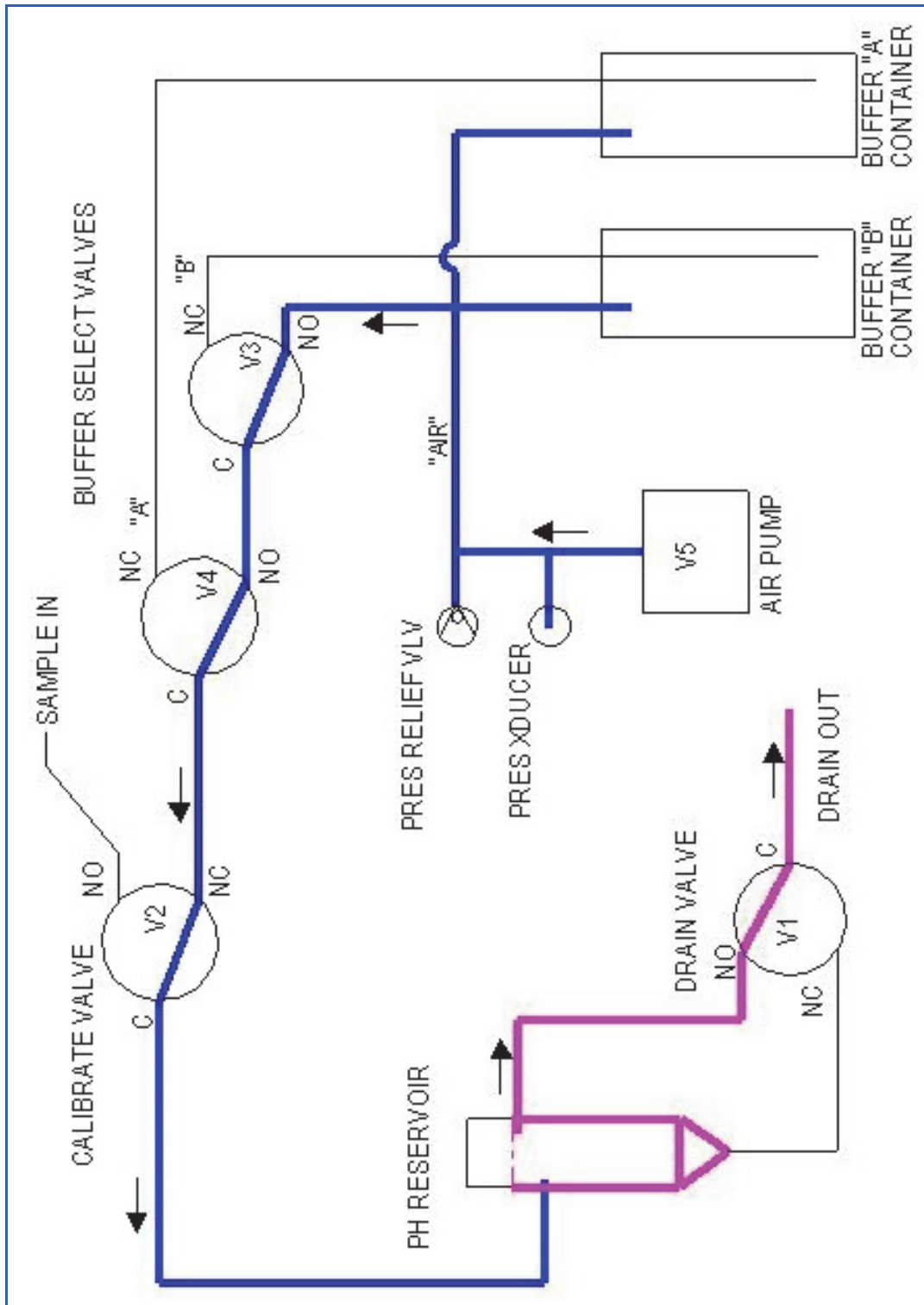

Figure 7.19. pHDetect sample drain (1)

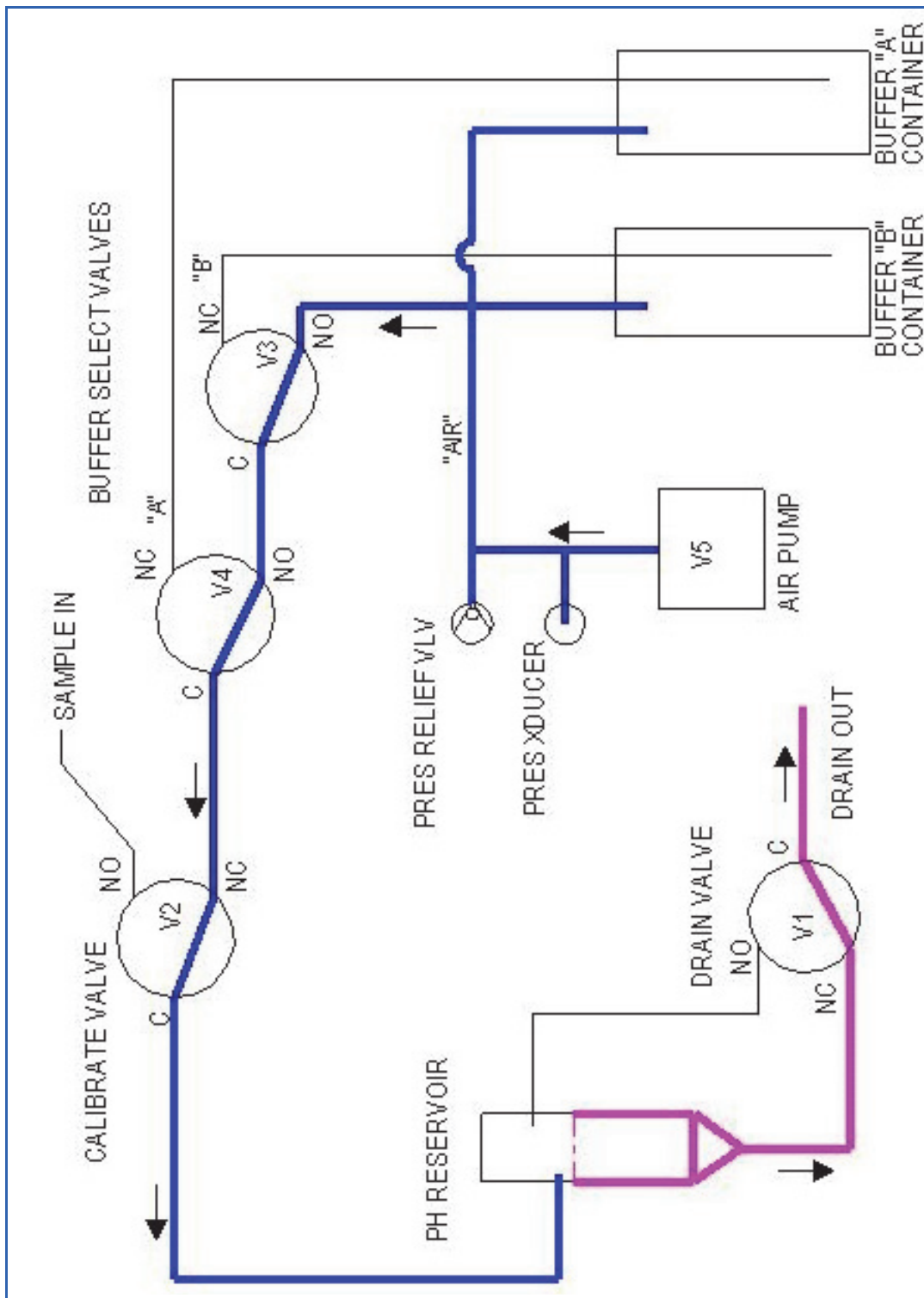

Figure 7.20. pHDetect sample drain (2)

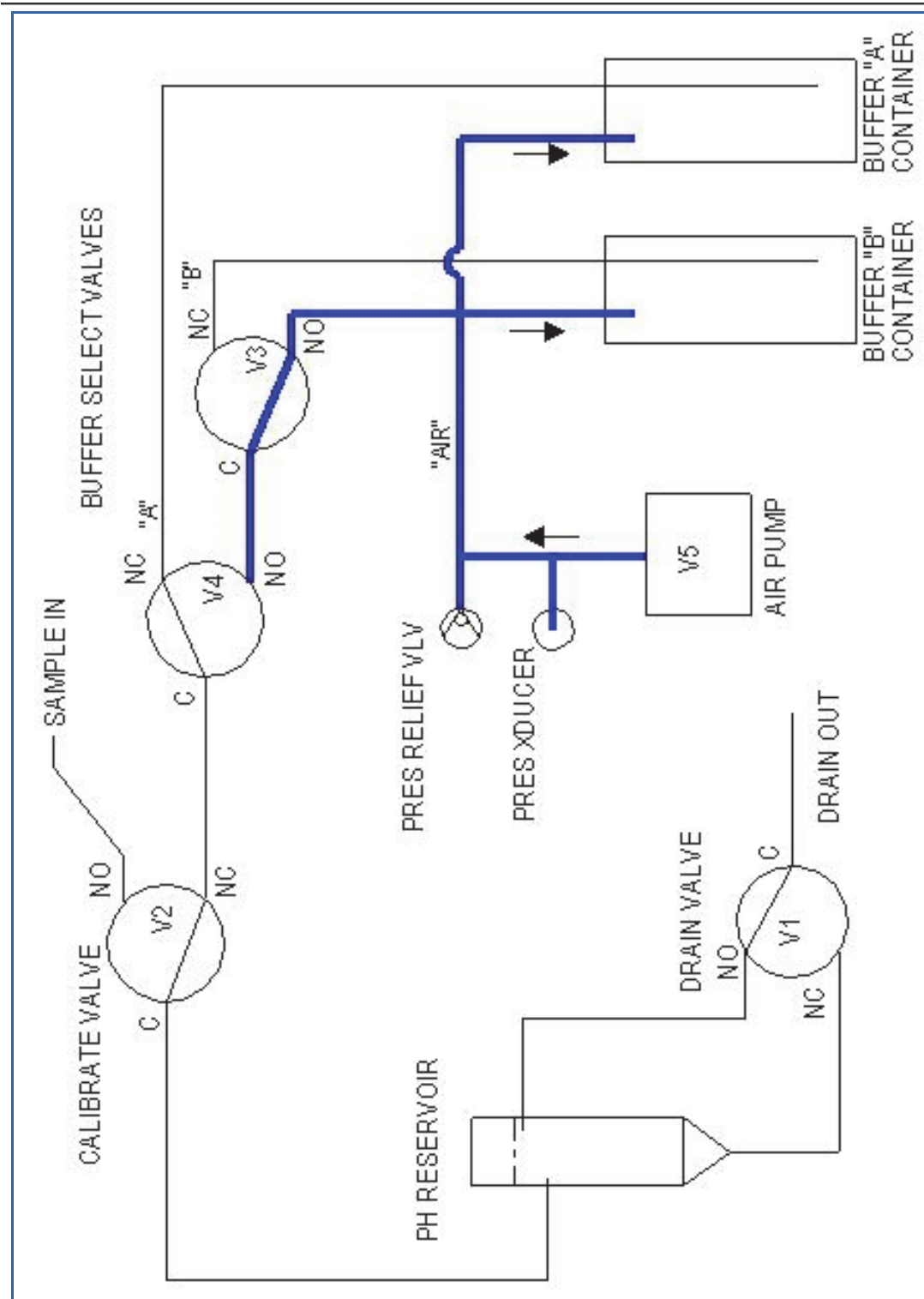

Figure 7.21. pHDetect pressurize

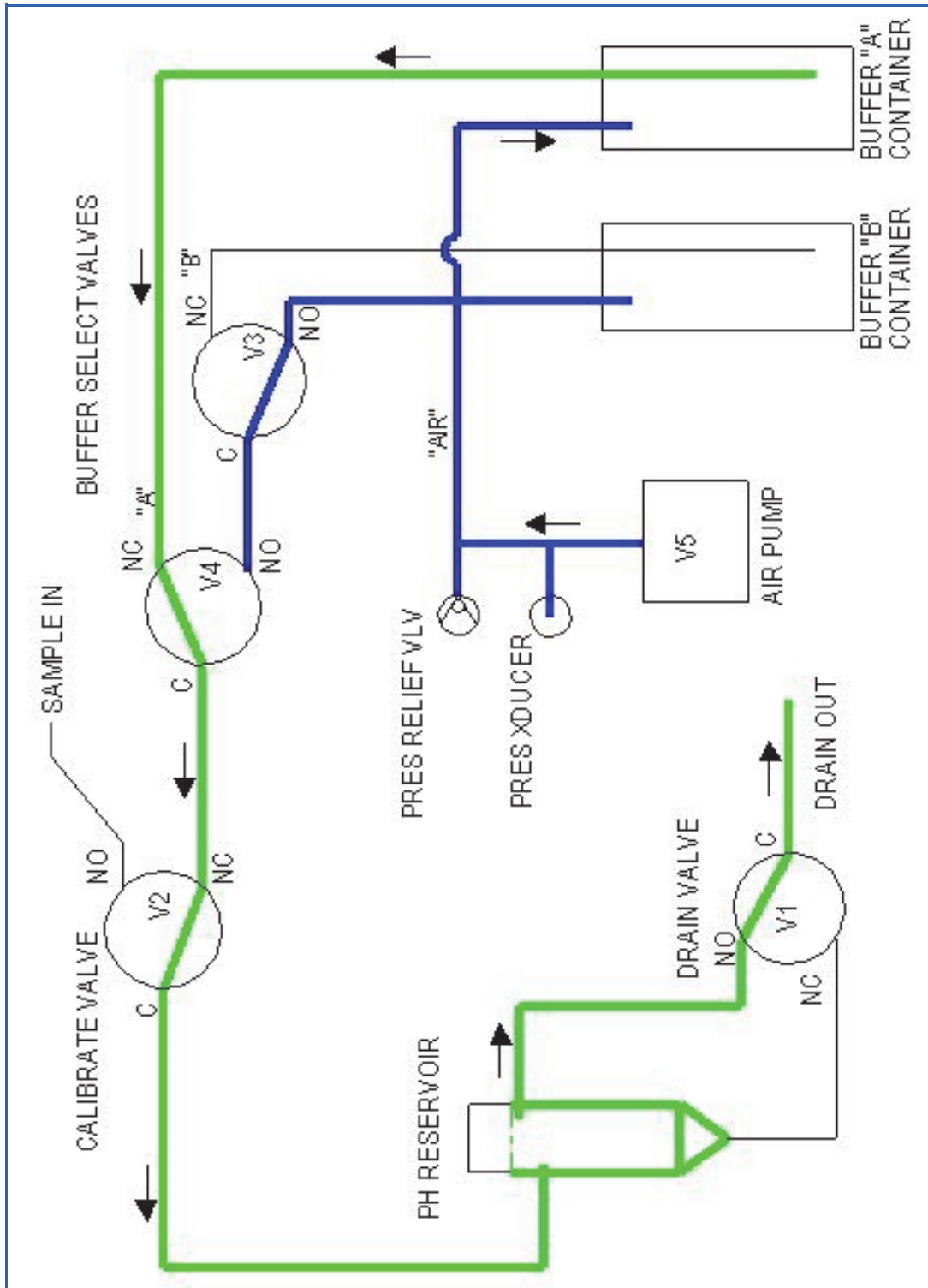

Figure 7.22. pHDetect fill cell with buffer A (typically pH 7.00)

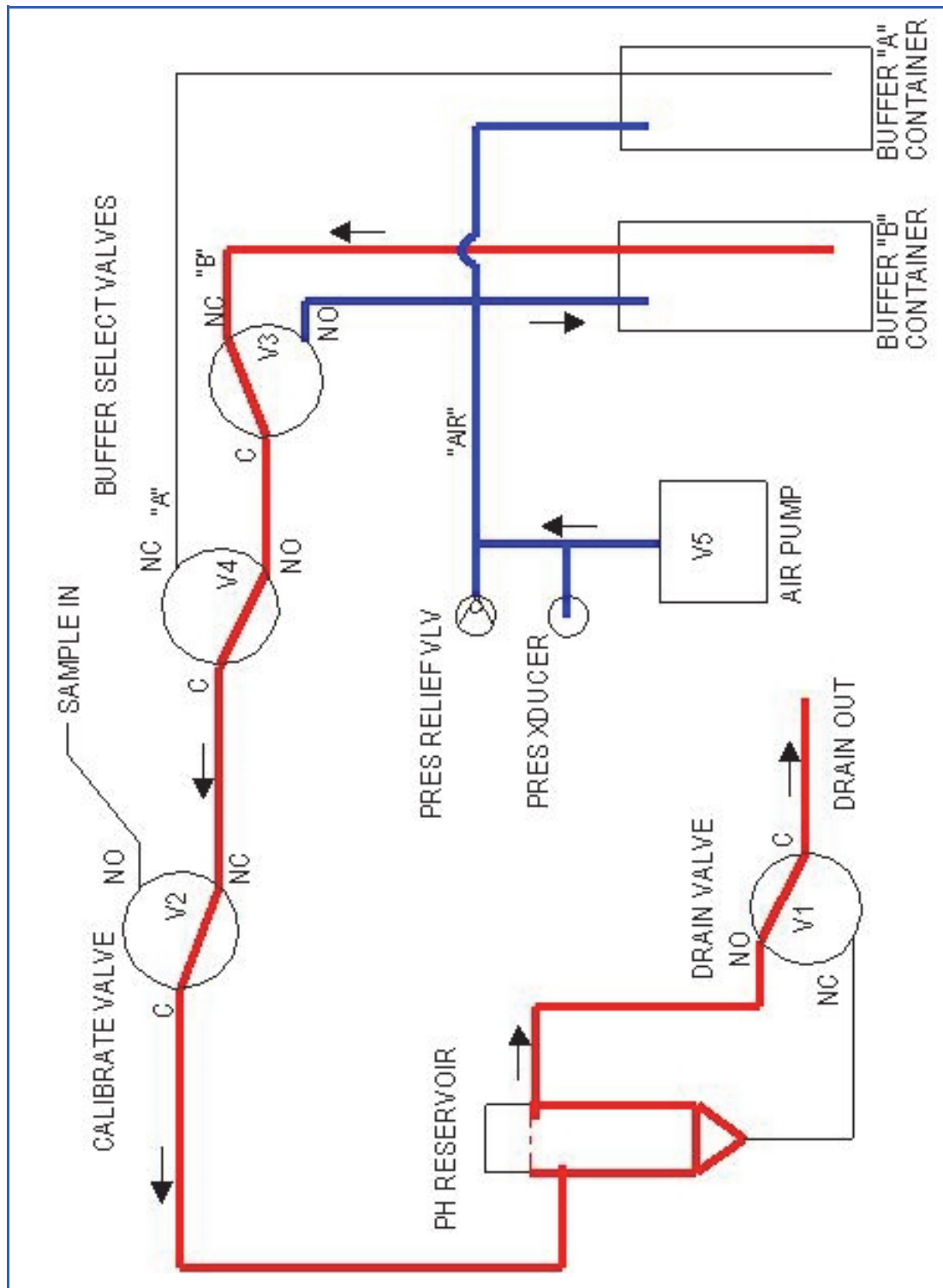

Figure 7.23. pHDetect fill cell with buffer B (typically pH 4.01)



Chapter 8 Foam Buster™ Option Installation

Installing the Foam Buster Option

OI Analytical usually installs the Foam Buster option in the factory. If necessary, install the Foam Buster™ option using the following instructions.

Removing the Standard Sparge Mount

1. Turn off the Eclipse and unplug the unit.
2. Remove the front and sparge mount covers. Open the pneumatics access cover. Remove the left side access panel by unscrewing the four screws.
3. Disconnect the drain line from the four-way (or three-way) injection valve (Figure 8.1).

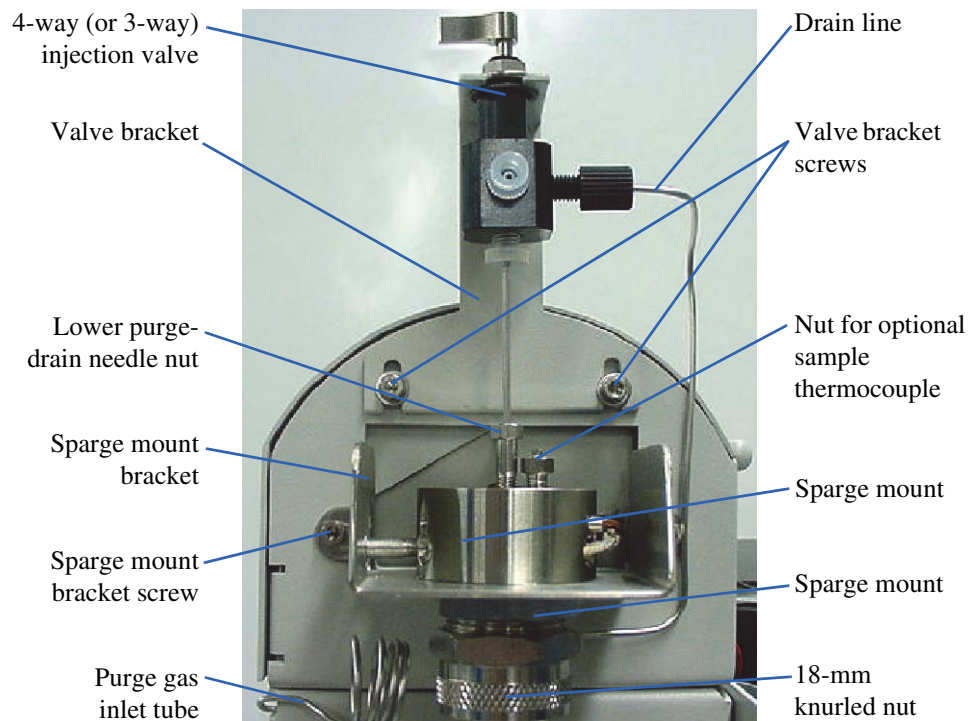

Figure 8.1. Eclipse sparge mount

4. Loosen the lower purge-drain needle nut.
5. Loosen the two screws on the valve bracket. Remove the injection valve with the valve bracket by pulling it upward.
6. Remove the glassware.

- Loosen the ¼" knurled nut on the purge gas inlet tube (frit spargers only).
 - Loosen the 18-mm knurled nut below the sparge mount.
 - Lower the glassware to clear it from the thermocouple and sample needle.
7. Remove the sparge mount plug or autosampler lines from the side port in the sparge mount, or remove the on-trap injector, if present.
 8. Loosen the sample thermocouple nut (present if the Infra-Sparge™ Sample Heater option is installed) or plug.
 9. Remove the metal clip (PN 182287) holding the sparge mount thermocouple and heater wires in place, located behind the sparge mount. Access it from the top of the instrument through the open pneumatics access cover (Figure 8.2).

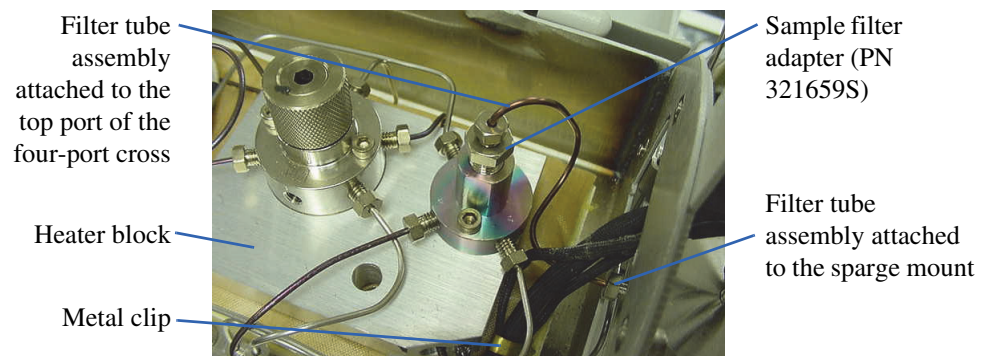

Figure 8.2. Top view of Eclipse plumbing

10. Remove the filter tube assembly (PN 321932) by unscrewing the fittings at the sparge mount and the top port of the four-port cross (PN 321658).
11. Loosen the 1Q/1" sparge mount nut located immediately below the sparge mount bracket.
12. Remove the two screws on both sides of the sparge mount bracket.
13. Tilt the sparge mount bracket up and remove the sparge mount bracket (Figure 8.3).



Figure 8.3. Removing the sparge mount bracket

14. Remove the sparge mount thermocouple and the sparge mount heater from the side of the sparge mount (Figure 8.4).
15. Remove the sparge mount by sliding it off of the sample thermocouple.

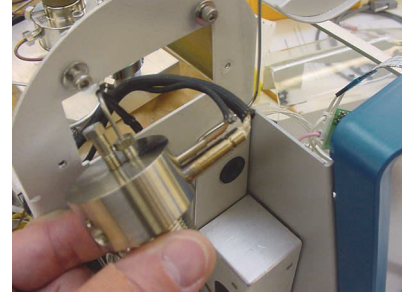

Figure 8.4. Removing the sparge mount thermocouple and heater

Installing the Foam Buster Sparge Mount

1. Remove the sample thermocouple nut and ferrule from the top of the standard sparge mount previously removed from the Eclipse. Discard the ferrule.
2. Install new Q/qy" glass-filled Teflon® ferrules (PN 177626) by placing the tapered end into top holes 1 and 3 of the Foam Buster sparge mount (Figure 8.5).

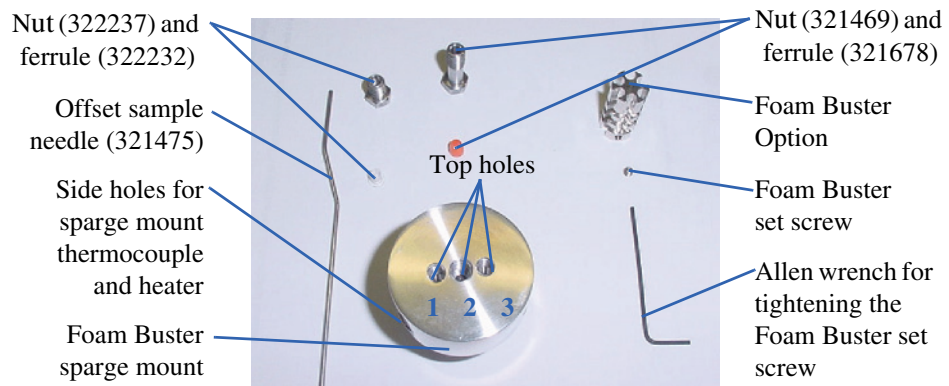

Figure 8.5. Foam Buster option parts

3. Loosely attach Q/qy" nuts into the Foam Buster sparge mount's top holes 1 and 3. Do not tighten.
4. If using the Infra-Sparge™ Sample Heater option, slide the sample thermocouple through the Foam Buster sparge mount's top hole 3. If not using the Infra-Sparge™ option, insert a plug (PN 217778) into top hole 3.
5. Insert the sparge mount thermocouple and heater in the side holes.
6. Insert the Foam Buster sparge mount onto the sparge mount bracket (Figure 8.6).
7. Install the 1Q/i" sparge mount nut onto the bottom of the sparge mount and tighten the fitting.



Figure 8.6. Installing the sparge mount bracket

8. Mount the sparge mount bracket onto the Eclipse using the mounting bracket's two screws.

Installing the Foam Buster Heater/ Thermocouple Assembly

1. Shape the lead on the top of the Foam Buster heater/thermocouple at ~45° angle.
2. Slide the nut (PN 321469) and orange Tefzel® ferrule (PN 321678) onto the Foam Buster heater/thermocouple (Figure 8.7).

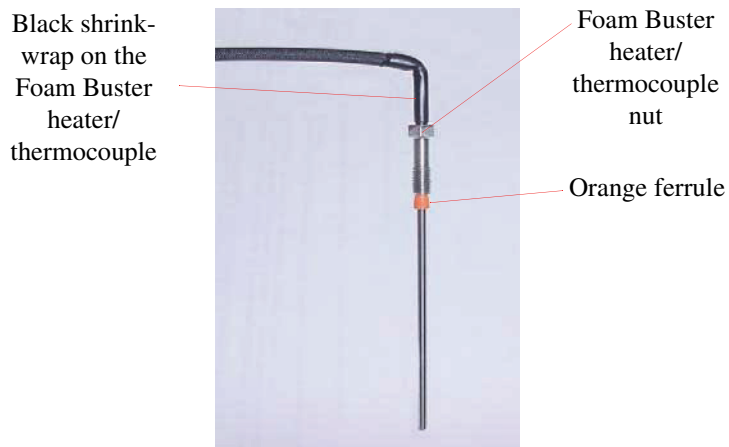

Figure 8.7. Foam Buster heater/thermocouple

3. Place the Foam Buster heater/thermocouple leads through the hole behind the sparge mount and into the valve oven area (Figure 8.8).
4. Insert the Foam Buster heater/thermocouple into the Foam Buster sparge mount's top hole 2.
5. Finger-tighten the Foam Buster heater/thermocouple nut.
6. Position the black shrink-wrap on the Foam Buster heater/thermocouple so it sits flush with the top of the nut (Figure 8.7).
7. Attach the sample line (Figure 8.2).
 - Attach one end of the sample line into the back of the sparge mount.
 - Attach the other end of the sample line into the top port of the four-port cross.

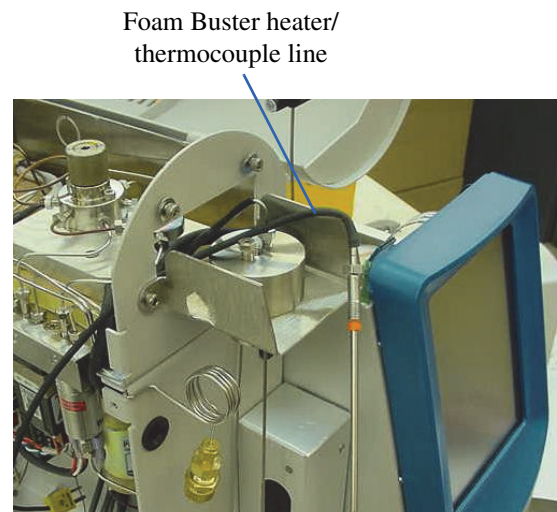

Figure 8.8. Installing the Foam Buster heater/thermocouple assembly

8. Tighten the Foam Buster heater/thermocouple nut while holding the Foam Buster heater/thermocouple in place (Figure 8.9).



Figure 8.9. Tightening the Foam Buster heater/thermocouple nut

Installing the Sample Needle

1. Remove the straight purge-drain needle from the four-way (or three-way) injection valve.
2. Insert the ferrule (PN 322232) onto the offset sample needle (Figure 8.10).
3. Insert the offset sample needle into the injection valve. Finger-tighten the fitting with the bend positioned to the left side of the valve.
4. Insert the offset sample needle into the Foam Buster sparge mount's top hole 1 (Figure 8.11).

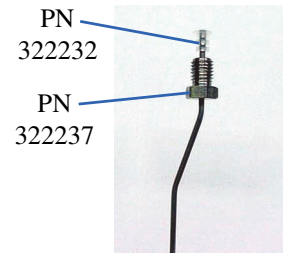

Figure 8.10. Offset sample needle with ferrule

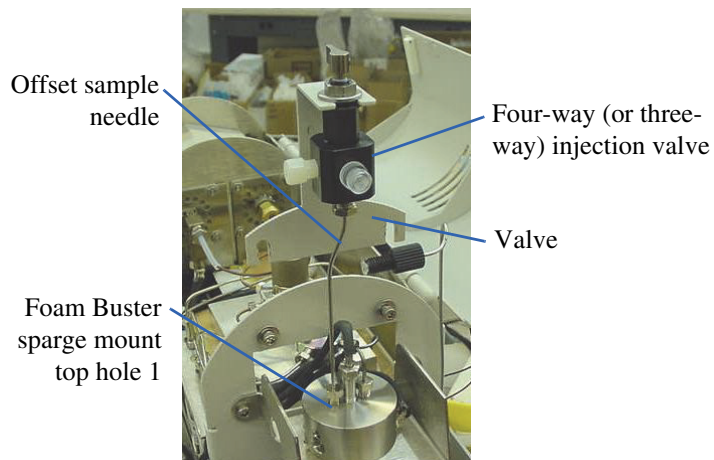

Figure 8.11. Installing the sample needle on the Foam Buster sparge mount

- Attach the valve bracket on the Eclipse (Figure 8.12). Do not tighten the screws.

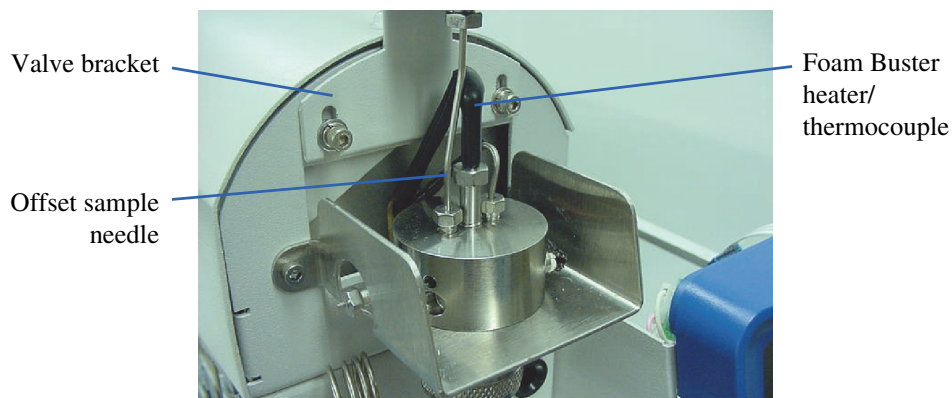

Figure 8.12. Installing the valve bracket on the Eclipse

Installing the Foam Buster Option

- Using the supplied Allen wrench, insert the set screw so it sits flush with the Foam Buster piece (Figure 8.13).

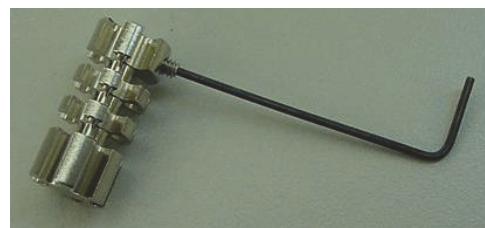

Figure 8.13. Inserting the Foam Buster set

- Insert the Foam Buster piece onto the Foam Buster heater/thermocouple with the set screw at the top. Position the Foam Buster piece with the sample needle and the sample thermocouple in the slots of the Foam Buster piece (Figure 8.14).
- Tighten the set screw using the Allen wrench. Do not overtighten.

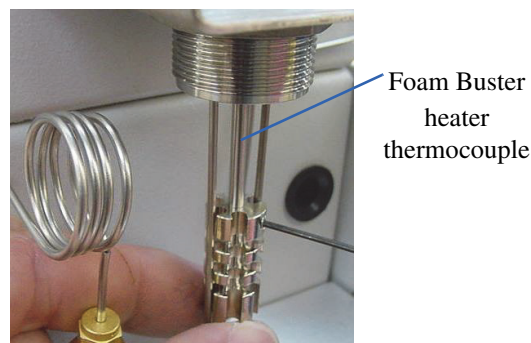

Figure 8.14. Installing the Foam Buster piece

Completing the Foam Buster Option Installation

- Install the appropriate glassware.

NOTE: Use a frosted sparge vessel with the Foam Buster option. See Chapter 3, “Installing Plumbing Connections” on page 35.
- Adjust the needle position by moving the valve bracket. The needle should touch the frit at the bottom of the frit sparge glassware, or the bottom of the needle sparge vessel.
- Tighten the two screws securing the four-way (or three-way) valve bracket in place.

4. Attach the drain line onto the four-way (or three-way) injection valve.
5. Tighten the lower purge-drain needle nut on the sparge mount. Tighten the upper purge-drain needle nut that attaches the sample needle onto the four-way (or three-way) injection valve.
6. Tighten the sample thermocouple nut, or tighten the plug if the Infra-Sparge™ Sample Heater option is not used. Do not overtighten.
7. From the left side of the Eclipse, release the three plastic harness clips that hold the thermocouple wires together.
8. Bundle the Foam Buster heater thermocouple wires together with the other thermocouple wires. Close the plastic harness clips.
9. Plug the Foam Buster heater and thermocouple wires into the I/O board. Plug the heater into J22. Remove the thermocouple jumper from J5 and plug in the thermocouple (Figure 8.15).

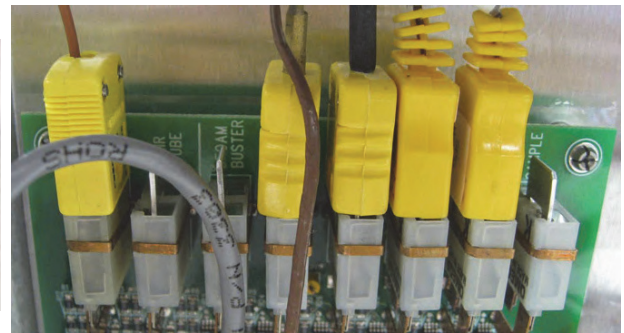
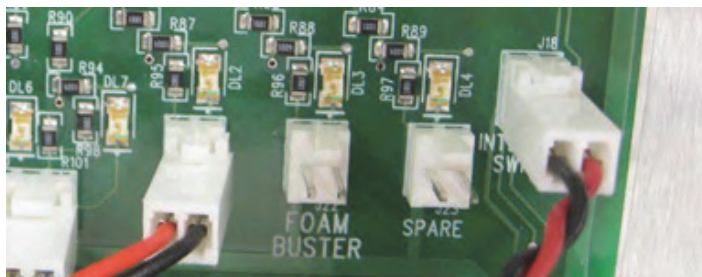

Figure 8.15. Plugging in the Foam Buster heater thermocouple wires

10. Install the sparge mount side plug or the autosampler transfer line.
11. Install the metal clip to bundle the wires together behind the sparge mount (Figure 8.2).
12. Replace the side access panel, pneumatics access cover, and sparge mount cover.
13. Plug in the Eclipse power cord. Turn on the power.
14. Enable the Foam Buster option.
 - Press the **Config** icon to access the General configuration screen. Modify an existing or create a new configuration (see Chapter 5, “Configuring the Eclipse” on page 87).

- From the Configure screen, press the **Options** tab to access the Options Configure screen (Figure 8.16).

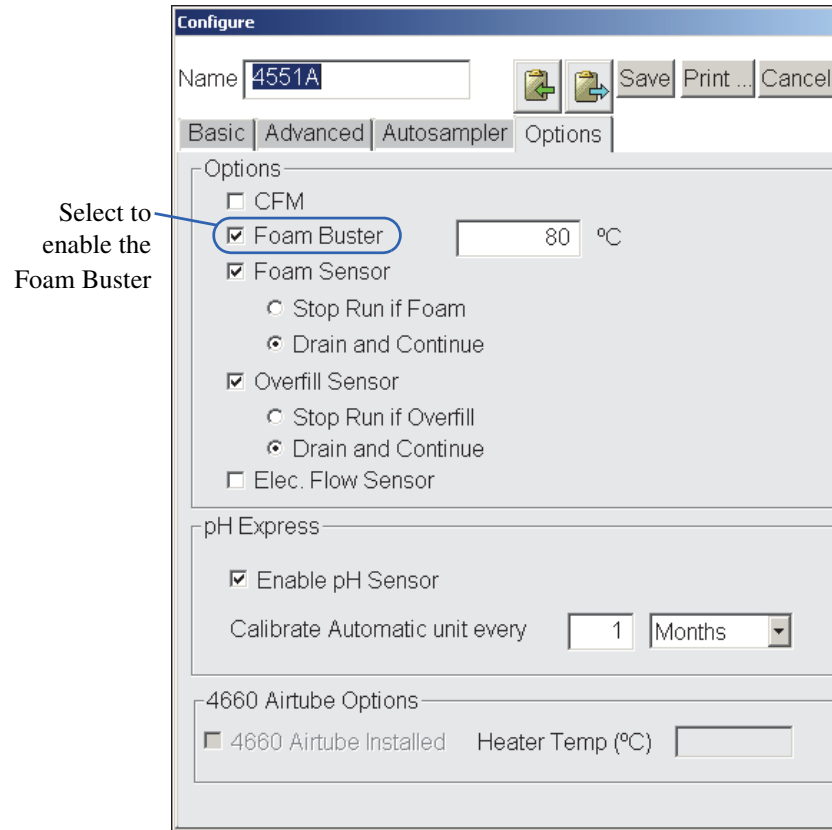

Figure 8.16. Options Configure screen

- Choose **Foam Buster** to enable the Foam Buster option.
 - Set the Foam Buster temperature set point. The recommended setting is 125°C.
 - Save the active configuration by pressing **Save**.
 - To make the configuration active, press and highlight its named icon and press **Make Active**.
15. Check the connections for leaks (see Chapter 3, “Performing a Leak Test” on page 42).

NOTE: If the Foam Buster is enabled and the sparge mount temperature is set to <50 °C in the method, the following message appears whenever the method is applied or loaded: “The Foam Buster is turned ON; it is recommended that sparge mount temp be set to 50 or higher.” The Foam Buster at 100 °C or higher makes the sparge mount temperature ~50 °C. If the sparge mount temperature is set to <50 °C, a temperature error occurs, stopping the Eclipse from entering purge ready.

Replacement Parts

Table 8.1. Foam Buster replacement parts

Product	Size	Unit	PN	XPN
Block for Foam Buster Option	—	each	321125	
Ferrule, ETFE,	Q/qy"	each	322248	*
Ferrule, Tefzel, flangeless	3 mm	each	321678	*
Ferrule, TFE	Q/qy" tube	each	177626	*
Ferrule, TFE	6-mm tube	each	224337	*
Fitting nut for Foam Buster Option, PEEK	Q/r-28 x Q/r-28	each	322237	*
Fitting, stainless steel for Foam Buster heater	Q/r-28 x 8 x 0.7	each	321469	*
Heater/sensor assembly for Foam Buster Option	—	each	321484	
Sample needle for frit sparging w/ Foam Buster Option	—	each	321475	
Sample needle for needle sparging w/ Foam Buster Option	—	each	321700	
Screw set SOC stainless steel, CUP	4-40 x Q/i"	each	131953	*
Sparge mount manifold for Foam Buster Option	—	each	320724	
Fitting and ferrule for Foam Buster needle ¹	Q/qy" x Q/r-28	set	322248	*

¹ Replaces the stainless steel and Cheminert ferrule on units shipped prior to May 17, 2004.



Chapter 9 Foam Sensor™ Option

Installing the Foam Sensor™ Option

1. Turn off the Eclipse and unplug the unit.
2. Remove the front, sparge mount, and pneumatics access covers.
3. Remove the glassware from the sparge mount by loosening the 18-mm nut and ferrule. Disconnect the purge gas inlet tube from the glassware by loosening the 6-mm nut and ferrule. Lower the glassware until it clears the needle and other options.
4. Remove the black nylon plug from the top left hole in the Eclipse chassis by squeezing the tabs on both sides of the plug (inside the chassis) and pushing the plug out of the hole (Figure 9.1).

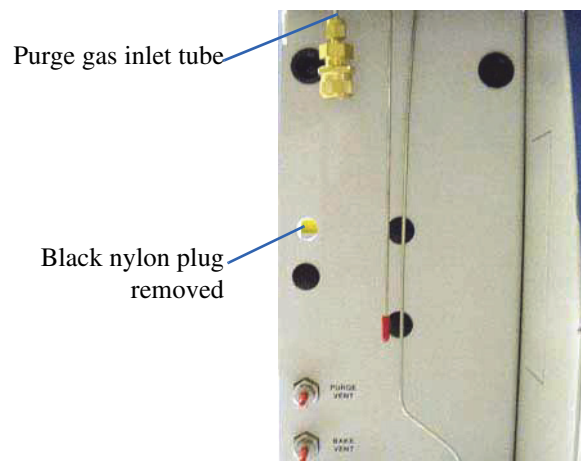

Figure 9.1. Remove the black nylon plug

5. Thread the connector end of the Foam Sensor cable (PN 321457) through the hole and into the chassis.
6. Plug the connector into the slot on the I/O board labeled “Foam Sensor” (J15; see Figure 9.2).

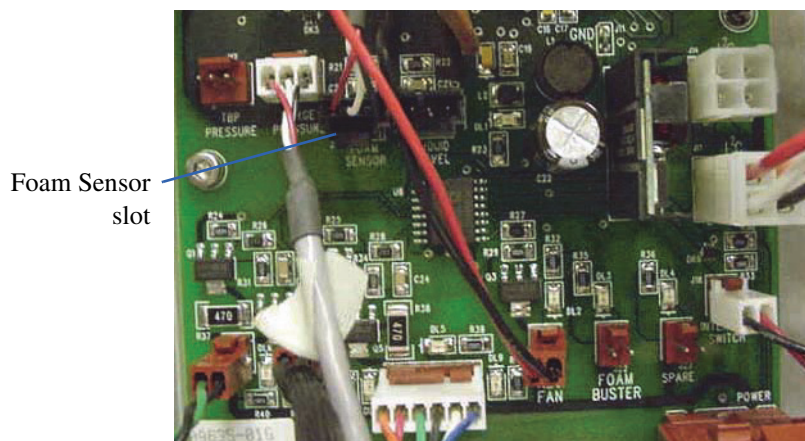

Figure 9.2. Plugging in the Foam Sensor cable

7. Route the cable through the wire clamps that bundle the internal cabling together.
8. Press the black grommet on the Foam Sensor cable into the chassis hole (see Figure 9.3).
9. Install the included snap-on ferrites onto the Foam Sensor cable. Install ferrite (PN 328365Q) near the connector and ferrite (PN 328366Q) inside the chassis near the grommet.
10. Reinstall the pneumatics access cover.
11. Test the Foam Sensor option using the following steps:
 - Plug in the Eclipse power cord. Turn on the power and log into the Eclipse software.
 - Press the **Maint** icon to access the Maintenance screen. Press **Diagnostics** to access the Diagnostics dialog box (Figure 9.4).

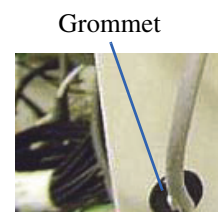

Figure 9.3. Placing the grommet in the chassis hole

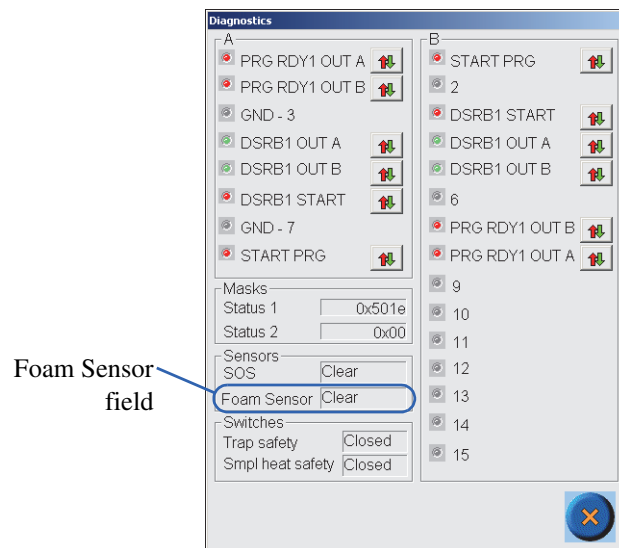

Figure 9.4. Diagnostics dialog box

- Observe the Foam Sensor field located in the lower left corner of the Diagnostics dialog box.
 - Trip the Foam Sensor option by sliding your finger or a thick pencil or pen into the ring. The Foam Sensor field should read “Tripped” after a 2–3 second delay.
 - Remove your finger or the object from the Foam Sensor ring. The Foam Sensor field should read “Clear” after a 2–3 second delay.
 - If the Foam Sensor field displays “Disabled” or “Not Present”, check the connection on the I/O board.
12. Loosen the knurled nut of the Foam Sensor option with three to four counterclockwise turns.
 13. Install the Foam Sensor ring by sliding it over the glassware with the smooth surface of the ring and dot facing up. If necessary, loosen the ring by unscrewing the standoff. Center the ring so the dot is located at the front of the sparger. Do not tighten the knurled nut of the Foam Sensor option (Figure 9.5).

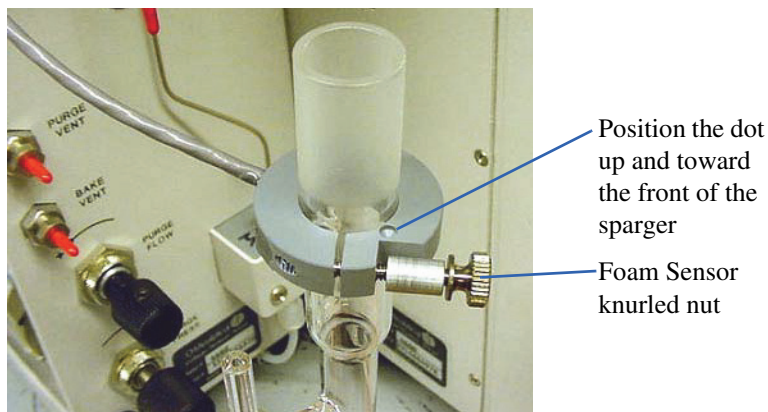

Figure 9.5. Positioning the Foam Sensor option on the glassware

14. Install the glassware as described in Chapter 3, “Installing Plumbing Connections” on page 35.

CAUTION:

Position the dot at the front of the sparger for proper Foam Sensor option operation.

15. Slide the Foam Sensor ring up toward the 18-mm nut, leaving about ¼–½" between the bottom of the 18-mm nut and the top of the ring. Center the ring so the dot is located at the front of the sparger. Tighten the ring using the knurled nut.

NOTE: If the Foam Buster option is installed, position the Foam Sensor ring *above* the Foam Buster heater block and below the 18-mm nut.

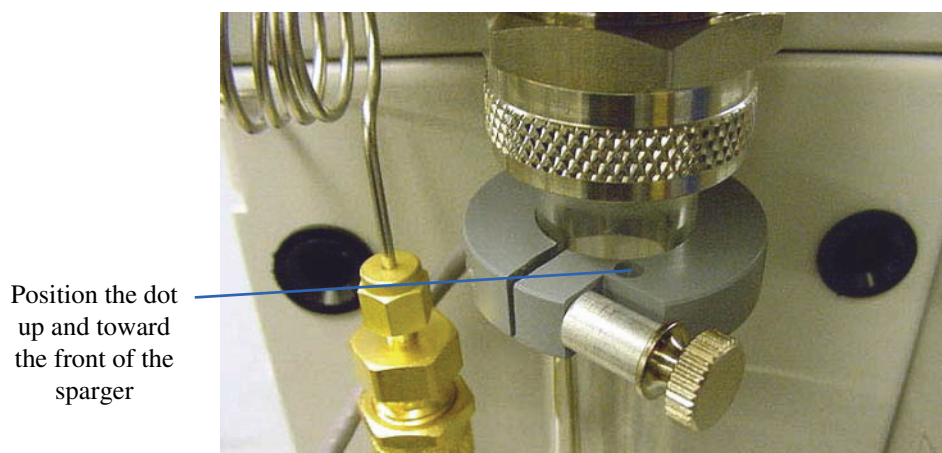

Figure 9.6. Installing the Foam Sensor option

16. Verify the Foam Sensor field on the Diagnostics screen reads “Clear.”
17. Reinstall the sparge mount and front covers.
18. Enable the Foam Sensor option.
 - Press the **Config** icon to access the General configuration screen. Modify an existing or create a new configuration (see Chapter 5, “Configuring the Eclipse” on page 87).

- From the Configure screen, press the **Options** tab to access the Options Configure screen (see Chapter 4, “Options Configure Screen” on page 71).
- Choose **Foam Sensor** to enable the Foam Sensor option.
- Choose **Stop Run if Foam** or **Drain and Continue** (see Chapter 4, “Options Configure Screen” on page 71).
- Save the active configuration by pressing **Save**.
- To make the configuration active, press and highlight its named icon and press **Make Active**.



Chapter 10 Sparge Overfill Sensor (SOS™) Option

Installing the SOS

Assembling the SOS

1. Place the SOS on the heat shield (PN 321589) with the printed side down and the target (cross) side up (see Figure 10.11, “Sparge Overfill Sensor” on page 184).
2. Insert the screws (PN 222836) into the holes on the SOS. Place nylon washers (PN 249722) and heat shield (PN 321589) on screws behind the SOS and attach the brass standoffs (PN 321171). Refer to Figure 10.11.



Figure 10.1. The SOS

Plugging in the SOS

1. Turn off the Eclipse and unplug the unit.
2. Remove the front, sparge mount, and pneumatics access covers.
3. Remove the sparger glassware from the sparge mount by loosening the 18-mm nut and ferrule. If using the frit sparger, disconnect the purge gas inlet tube from the glassware by loosening the 6-mm nut and ferrule; lower the glassware until it clears the needle and other options.
4. Remove the black nylon plug from the lower left hole in the Eclipse chassis by squeezing the tabs on both sides of the plug (inside the chassis) and pushing the plug out of the hole.

- Remove the black nylon plugs from the two middle holes behind the purge-drain needle (Figure 10.2). Insert black bushings from the SOS kit into these two holes.

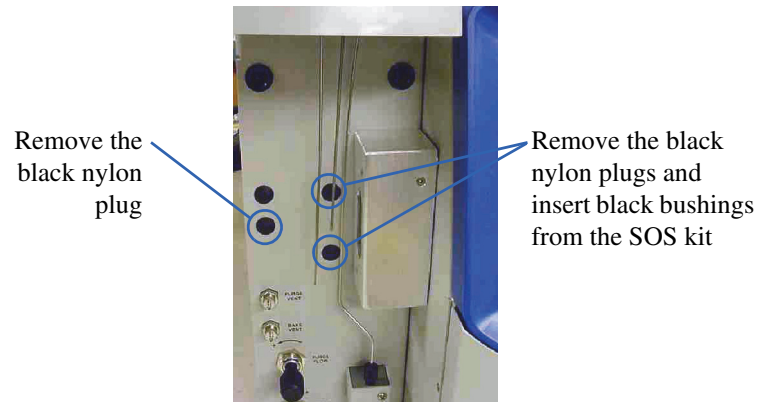

Figure 10.2. Remove the black nylon plugs

- Thread the connector end of the SOS cable (PN 321488) through the lower left hole and into the chassis.
- Plug the connector into the slot on the I/O board labeled “Liquid Level” (J16).

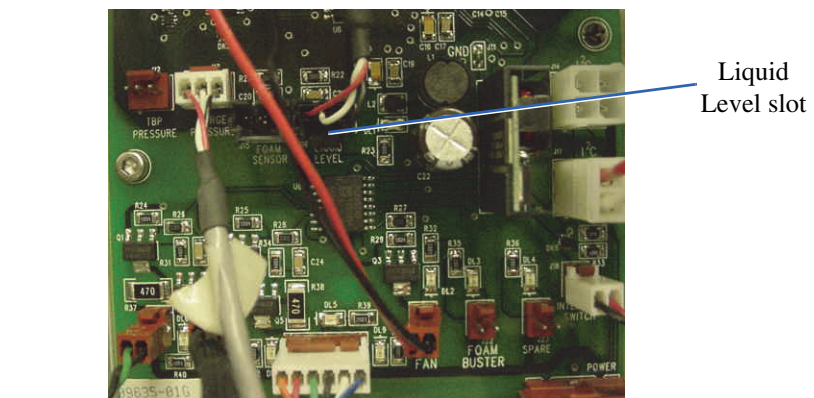

Figure 10.3. Plugging in the SOS cable

- Route the cable through the wire clamps that bundle the internal cabling together.
- Press the black bushing on the SOS cable into the chassis hole.
- Install the included snap-on ferrites onto the SOS cable. Install ferrite (PN 328365Q) near the connector and ferrite (PN 328366Q) inside the chassis near the grommet.
- Plug in the Eclipse power cord and power on the unit. The sensor’s green light should switch on.
 - If the green light does not switch on, check the SOS cable connection. Verify it is installed in the correct slot on the I/O board.
- Place your finger over the SOS target. The sensor’s orange light should switch on.

Adjusting the SOS

OI Analytical calibrates the SOS in the factory using drinking water. Sample salt and solids content, and sparger condition, age, and cleanliness can influence the SOS response. SOS sensitivity may need adjusting depending on the sample types being analyzed or over time as the instrument is used.

If necessary, adjust the sensitivity of the sensor using the following procedure:

NOTE: The SOS can be adjusted with the sparge vessel in place on the Eclipse. However, accessing the adjustment screw is difficult, particularly if an Infra-Sparge™ option is installed.

1. Locate the small adjustment screwdriver in the SOS kit (Figure 10.4).
2. Locate a glass sparge vessel. Add liquid to the sparge vessel so it contains 1.5–2.0 cm (0.5–0.75") of liquid. Use liquid that is similar to the analyzed samples.
3. Touch and hold the SOS target to the sparge vessel.
4. Turn the adjustment screw located on the top of the SOS using the adjustment screwdriver. Turning the screw counterclockwise makes the sensor less sensitive and turning it clockwise makes the sensor more sensitive. Adjust the sensitivity so the water in the sparge vessel does not actuate the sensor and the orange light does not switch on (Figure 10.5).

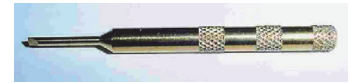

Figure 10.4. Adjustment screwdriver

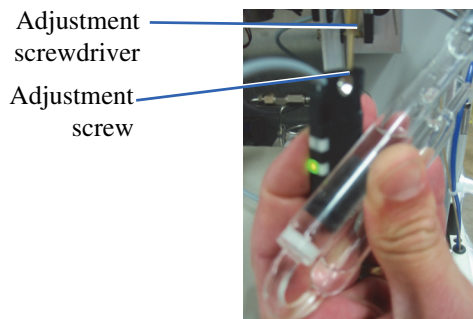

Figure 10.5. Liquid in the sparge vessel does not actuate the sensor

5. Slowly turn the screw clockwise until the sensor actuates and the orange light goes on (Figure 10.6); turn the screw clockwise an additional ½–¼ turn.

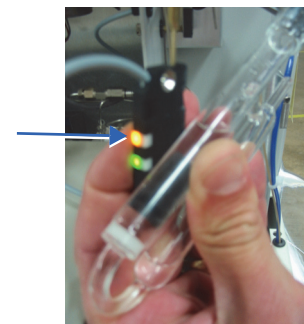

Figure 10.6. Liquid in the sparge vessel actuates the sensor

Installing the SOS Assembly

CAUTION:

If the purge-drain needle is not bent forward, the SOS can give false responses.

1. Turn off power to the Eclipse and unplug the unit.
2. Bend the purge-drain needle forward slightly about six inches above the bottom to provide room for the SOS. With the spurge vessel installed, the bent needle should be positioned in front of the vessel (Figure 10.7).
3. Slide the springs (PN 321580) onto the brass standoffs.
4. Orient the SOS with the LEDs and cable on the left side (Figure 10.8). Carefully insert the brass standoffs into the two black bushings located behind the purge-drain needle.

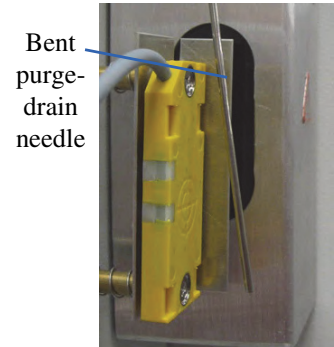

Figure 10.7. Purge-drain needle bent to provide room for the SOS

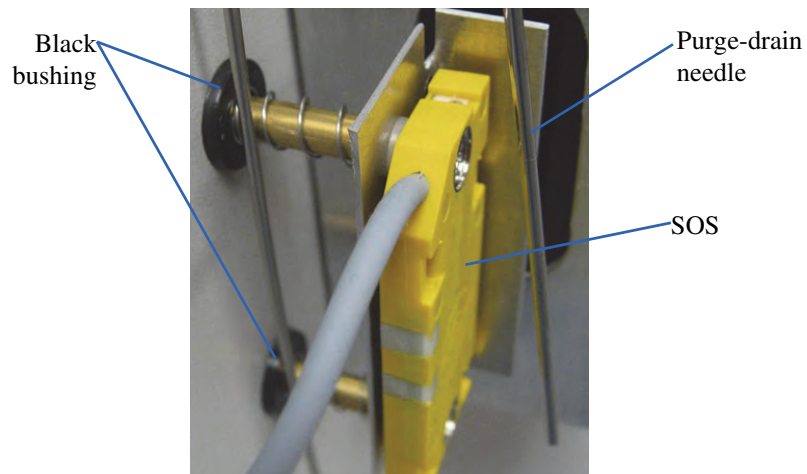

Figure 10.8. Inserting the SOS brass standoffs into the black bushings

5. Attach the knurled nuts (PN 230938) to the brass standoffs from inside the chassis. Finger-tighten the nuts.
6. Press on the SOS. The SOS should spring back easily.
7. Carefully reinstall the glassware as described in Chapter 3, “Installing Plumbing Connections” on page 35.

NOTE: Press on the SOS to keep it aside while installing the glassware.

8. Reinstall the spurge mount and pneumatics access covers.
9. Plug in the Eclipse power cord and power on the unit. Log into the Eclipse software.

10. Press the **Maint** icon to access the Maintenance screen. Press **Diagnostics** to access the Diagnostics dialog box (Figure 10.9).

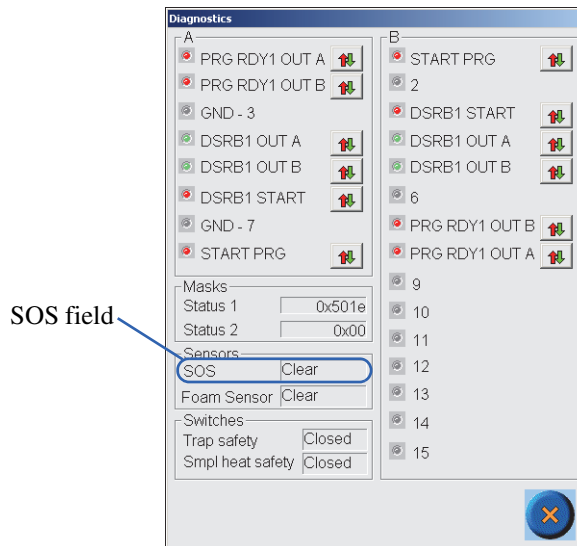

Figure 10.9. Diagnostics dialog box

11. Observe the SOS field located in the lower left corner of the Diagnostics dialog box. The SOS field should read “Clear.”
- If the SOS field reads “Not Present”, check the SOS cable connection. If the problem continues, contact the OI Analytical Customer Support Center at (800) 336-1911 or (979) 690-1711.
12. Using a syringe, manually fill the sparge vessel with water through the four-way (or three-way) valve so the sparge vessel contains 1.5–2.0 cm (0.5–0.75") of liquid. The SOS field should read “Tripped” after a 2–3 second delay.

NOTE: The SOS can be adjusted with the sparge vessel in place on the Eclipse. However, accessing the adjustment screw is difficult, particularly if an Infra-Sparge™ option is installed.

13. Enable the SOS.
- Press the **Config** icon to access the General configuration screen. Modify an existing or create a new configuration (see Chapter 5, “Configuring the Eclipse” on page 87).
 - From the Configure screen, press the **Options** tab to access the Options Configure screen (Figure 10.10).

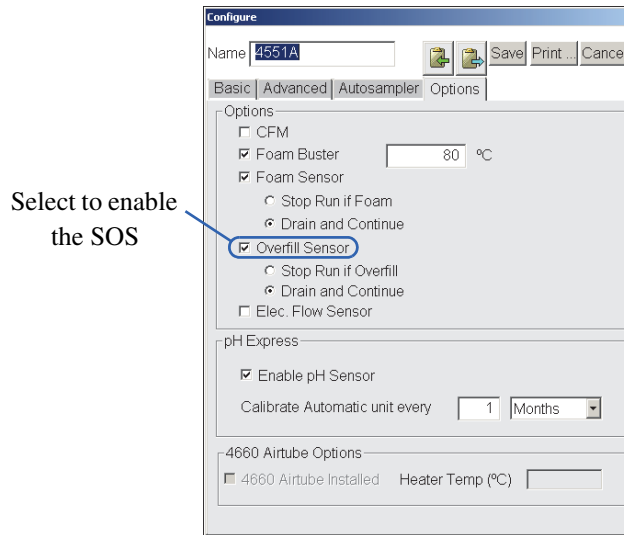

Figure 10.10. Enabling the SOS

- Choose **Overfill Sensor** to enable the SOS.
- Choose **Stop Run if Overfill** or **Drain and Continue** (see Chapter 4, “Options Configure Screen” on page 71).
- Save the active configuration by pressing **Save**.
- To make the configuration active, press and highlight its named icon and press **Make Active**.

Replacement Parts

Table 10.1. SOS replacement parts

Product	Size	Unit	PN
Bushing, snap	E/i" hole x 0.188" I.D.	each	321170
Compression spring, stainless steel	0.240 x 0.75	each	321580
SOS adjustment screwdriver	—	each	321599
SOS assembly	—	each	321488
SOS shield	—	each	321589
Standoff, brass, female/female	4-40 x 1.00	each	321171
Thumbscrew, brass/nickel	4-40 x ¼	each	230938

Assembly Diagram

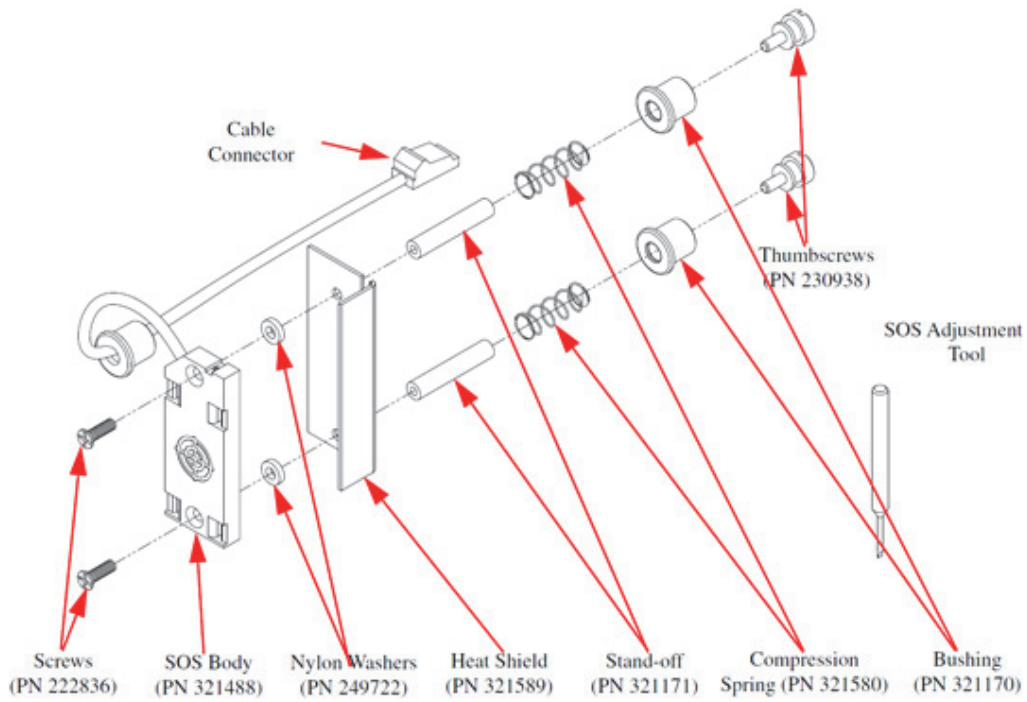

Figure 10.11. Sparge Overfill Sensor



Chapter 11 On-Trap Injector Option

Installing the On-Trap Injector Option

1. Remove the sparge fitting plug assembly on the sparge manifold; see Figure 11.1.

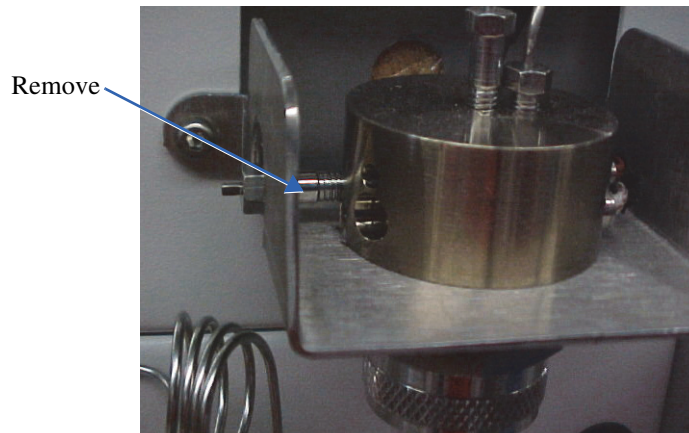

Figure 11.1. Remove the sparge fitting plug assembly

2. Remove the injector tube liner and injector fitting adapter from the On-Trap Injector Kit (part number 321676); install the liner into the fitting adapter.
3. Install the injector fitting assembly with the liner into the sparge manifold as shown in Figure 11.2.

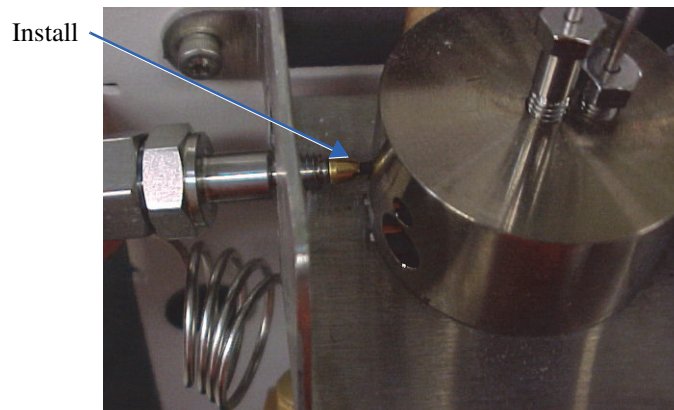

Figure 11.2. Installing the injector assembly

4. Tighten as indicated in Figure 11.3.

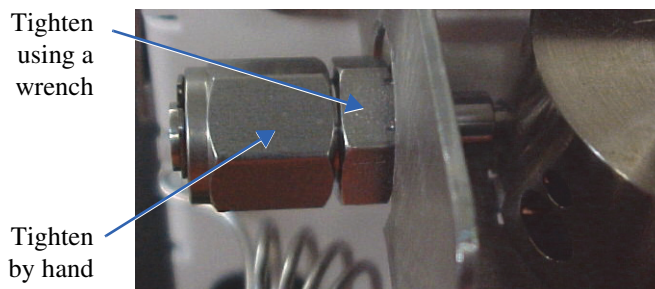

Figure 11.3. Tighten the assembly

5. Verify the fitting nut on the injector fitting adapter is hand-tight to prevent leaks.

NOTE: The fitting adapter septum will need to be replaced after several injections. The kit comes with a pack of five; see Figure 11.4 for septum location.

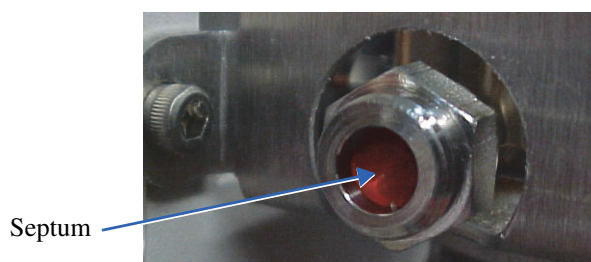

Figure 11.4. Locating the septum

6. Perform a leak test on the Eclipse.

Operating the On-Trap Injector Option

1. Change the Eclipse active configuration to “No Sampler”.
2. Confirm the active configuration settings by pressing View/Modify.
3. Load a method into the Active Method screen (refer to Chapter 5, “Using Active Methods” on page 95).
4. Using a syringe with a 2"-long needle, load 1 μ L of sample into the syringe.

NOTE: A 2"-long needle is required to ensure the tip of the needle extends into the sample pathway.

5. Insert the syringe into the septum until the barrel of the syringe touches the septum nut.
6. Start the run on the Eclipse.

7. When the Eclipse Purge state begins, inject the sample into the Eclipse.

NOTE: The Eclipse purge gas sweeps the sample to the trap; therefore, for best results, the Eclipse must be in Purge when the sample is injected.

8. Remove the syringe and allow the run to proceed normally.

Assembly Diagram

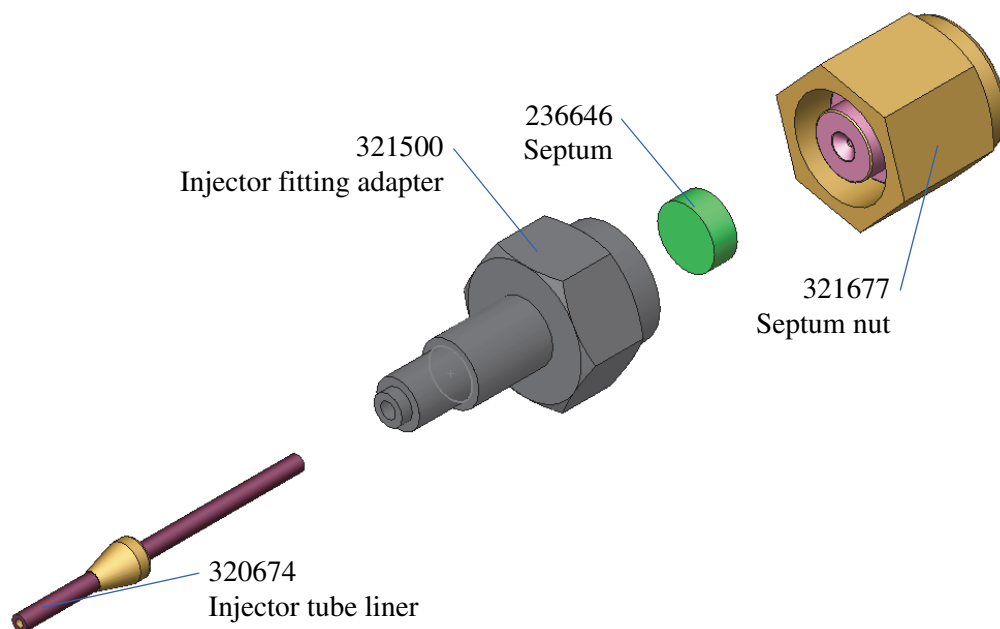

Figure 11.5. On-trap injector assembly



Chapter 12 Troubleshooting

Eclipse Diagnostic Tools

This chapter provides troubleshooting information for the Eclipse.

Maintenance Screen

The Maintenance screen contains important diagnostic tools such as Manual Advance State, Leak Test, and pH Settings. For complete information, see Chapter 6, “Maintenance” on page 101.

Purge Flow Controller and Purge Gas Pressure

The Eclipse uses a flow controller rather than a simple needle valve for purge flow control. This design allows the system to maintain an exact flow rate regardless of trap restriction variations. A pressure gauge connected to the flow controller output monitors the gas pressure required to maintain the set flow. During purge, the purge gas flows sequentially through the following components:

- Dry purge valve
- Purge line
- Sparge vessel
- Valve oven lines
- Trap
- Bake valve, to vent

These components generate backpressure of about 6–12 psi while maintaining 40 mL/minute purge flow, depending on the trapping sorbents used. If pressure greater than 12 psi occurs during purge, one of these five components causes too great a restriction. The remaining components do not cause a measurable drop unless malfunctioning. If observing too great a pressure, find the restriction by isolating the first component, then the first two together, then the first three, etc.

If noting low pressure during purge, leaking occurs involving these components. First, check the trap connections to their bulkhead fittings and the sparger neck seal. To locate this type of leak, manually advance to purge, then plug the barbed fitting where purge flow is measured. When plugged, purge flow ceases, so the flow controller increases purge pressure in an attempt to maintain the purge flow rate. This pressure gauge shows the rise in pressure, which should stabilize at 20 psi. At this point, the components listed above are pressurized to 20 psi and finding a leak is easier.

The purge gas indicator readings in other states are also useful. Approximate values for each state are as follows:

Standby/purge ready	1–2 psi
Purge	6–12 psi
Dry purge	4–7 psi
Purge complete/desorb ready	3–7 psi
Desorb with drain	2–4 psi
Backflush bake w/o purge	1–3 psi
Backflush bake w/o purge	2–4 psi
Desorb w/o drain	2–4 psi

The trap is not online with the purge gas during states where the purge gas indicator reads 1–4 psi, so less pressure is required to maintain the preset flow. If the pressure during these states rises to an abnormally high level, then a blockage, crimp, or other restriction exists between the purge gas regulator and the bake vent or drain. In this case, check the sample needle, sample valve, drain valve, drain line to waste, and bake vent valve.

Using the PING Diagnostic

Use the MS-DOS® Ping diagnostic utility to confirm correct TCPIP configuration, assignment of instrument IP addresses and subnet mask, and LAN cable and hardware functionality.

To use the Ping utility, do the following:

1. Select **Run...** to access the Command Prompt from the Windows Start Menu.
2. Enter “Ping” at the DOS prompt to view the Ping menu and options (Figure 12.1).

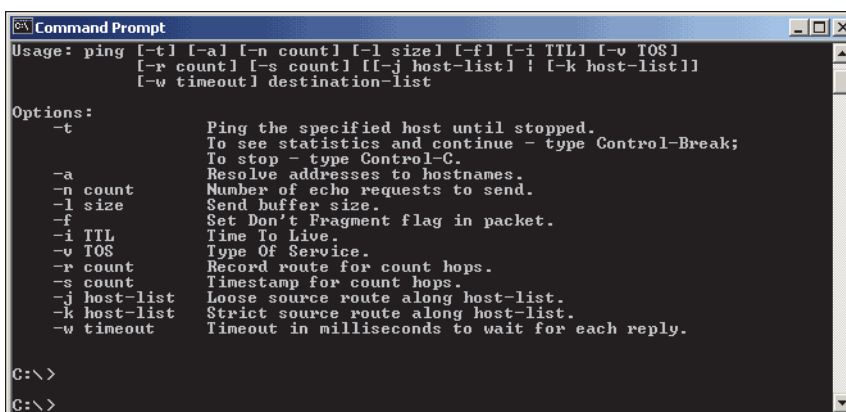

Figure 12.1. Ping menu and options

- To test the network connection, enter **Ping** followed by the IP address of the instrument to be tested. The Ping utility makes four data transmissions to the specified IP address and reports the reply if successful (Figure 12.2). If the data transmission fails, the PING utility reports “Request timed out.”

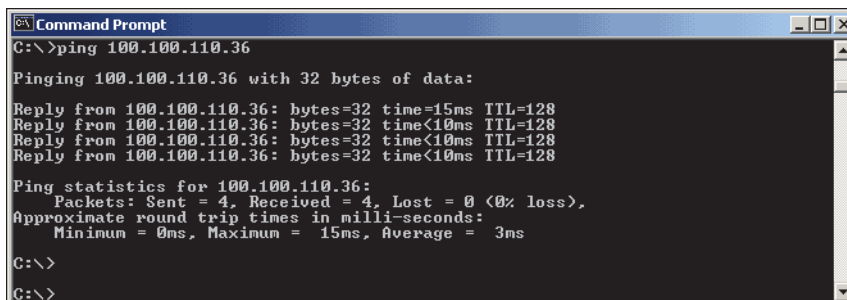

Figure 12.2. Successful Ping test

Eclipse Error Messages

Short Error Messages (shown in red in the lower right hand corner of Status screen)	Detailed Error Messages	Explanation
Low purge gas pressure in Pre-Purge or Purge, run will continue	Low gas pressure during purge and pre-purge, check for leaks and adjust flow regulator	The pressure falls below the specified pressure when the low pressure alarm was enabled in the configuration. Check for leaks and check the gas supply connection.
System overpressure, run will stop	System overpressure, run will stop, adjust pressure regulator	Whenever the system pressure rises above 28 psi, the Eclipse opens the bake vent and stops the run for safety purposes. Check for blockages. Check the pressure regulator.
4551 Cover Off or Low Gas	4551 Cover Off or Low Gas: replace the cover and check the autosampler gas supply	With Model 4551A connected, the Eclipse detects the stated condition. Check the cover. Check the gas supply connection to the Model 4551A.
Trap Cover Open	Trap cover open during Desorb/Bake, trap may not have heated properly	The trap (curved pneumatics access) cover is open (with firmware rev. bw or greater). Close the trap cover. If error still appears, check the overtemperature switch and the magnetic switches.

Short Error Messages (shown in red in the lower right hand corner of Status screen)	Detailed Error Messages	Explanation
Sample Cover Off	Sample Cover Off: sample will not heat with cover removed	The clear front cover is removed when the Infra-Sparge™ option is installed. The message also appears if the magnetic sensor in the cover does not engage, or if the overtemperature switch for the sample heater trips. Replace the front cover. If error still appears, check the overtemperature switch.
Error In Connection	Connection to the device may be lost	The LAN connection to the PC software is lost. Exit and restart the PC software.
Heater Error Detected	Types of errors include “heater not responding”, “open thermocouple”, “overtemp”. The message also includes the name of the heated zone showing the malfunction; for example, TRAP HEATER NOT RESPONDING or SAMPLE HEATER OPEN THERMOCOUPLE.	When a heater error occurs, the heated zone becomes disabled. Press Abort to clear the error. Open thermocouple: an actual temperature reads >1,000 °C. Check that the thermocouple is plugged in. Ensure the trap cover does not touch the trap. Overtemp: the actual temperature is greater than the maximum allowable temperature for the zone. Call the OI Analytical Customer Support Center at (800) 336-1911 for assistance. Not responding: the heated zone did not heat at the expected rate. Call the OI Analytical Customer Support Center at (800) 336-1911 for assistance.
Leak Check: A PASS, B FAIL	Part B FAILED - pressure drop more than 0.5 psi in 1 minute	If part B failed, an isolated leak occurred in the six-port valve, water management fitting, trap, or trap bulkhead fitting
	Part B FAILED - system pressure below 10 psi after valve switched	Part B failed because of a massive leak. Check the trap, water management, and bulkhead fitting connections.

Short Error Messages (shown in red in the lower right hand corner of Status screen)	Detailed Error Messages	Explanation
Leak Check: A FAIL, B n/a	Part A FAILED - pressure drop more than 0.8 psi in 2 min	Part A failed. Therefore, the leak did not occur in the trap area, but could be located anywhere else in the system. The most common places the leak could occur are around the sparge glassware and autosampler connections.
	Part A FAILED - system did not pressurize to at least 15 psi	Either the pressure is not set high enough, or a massive leak occurred. Check the gas supply connection. Ensure all fittings are tight.
	Part A FAILED - system pressurized above 28 psi, adjust regulator and retry	The pressure is set too high, and the leak check stopped for safety reasons. Adjust the pressure regulator.
Turn power OFF then ON	Unable to communicate with 4551 - switch Eclipse power OFF then back ON	Check the Model 4551A power. Check the interface cable between Eclipse and the Model 4551A.

System Performance Troubleshooting

Contaminant Peaks

NOTE: For flow diagrams, see Figure 12.3 and Figure 12.4

1. Isolate the problem by disconnecting the Eclipse from the GC. Remove the transfer line from the GC and replumb the lines to restore carrier flow to the injector. Run a typical oven temperature profile.
 - If contaminant peaks are still present, check the column or injector.
 - Reinstall the column after removing the column ends.
 - Install a test column to isolate the problem to the column.
 - Replace the septum.
 - Clean the injector.
2. Reconnect the Eclipse to the GC and remove any autosamplers connected to the Eclipse. Rerun the typical oven temperature profile.
 - If contaminant peaks are not present, check the autosampler.
 - Check if the contamination occurs using a blank vial.
 - Verify the transfer lines heat.
 - Flush the lines between the autosampler and Eclipse.

3. If contaminant peaks are still present, check if the contaminant peak response is proportional to the purge time. Decrease the Eclipse's purge time to two to three minutes. Rerun the typical oven temperature profile.
 - If contaminant peaks are not present, the cause resides in the desorb pathway lines or the trap. Rinse the transfer line according to Chapter 6, "Rinsing the Eclipse Transfer Line" on page 131
 - If contaminant peaks are present and the peak response is proportional to the purge time, the cause resides in the purge pathway. Rinse the sample pathway according to Chapter 6, "Rinsing the Eclipse Sample Pathway (not including the transfer line)" on page 128.
4. Check the desorb pathway by baking the trap for four to five minutes. Advance to standby, allow the trap to cool, then manually advance to desorb (no purge). Rerun the typical oven temperature profile.
 - If contaminant peaks are present, check the trap by setting the desorb temperature to 0 °C and rerunning the profile.
 - If contaminant peaks are not present, the cause resides with the trap. Install a new trap. Condition the trap and verify trap cleanup over a few P&T cycles.
 - If contaminant peaks are still present, call the OI Analytical Customer Support Center for assistance.
5. Check the purge pathway by setting the purge time to zero minutes and the dry purge time to four to five minutes. Rerun the profile.
 - If contaminant peaks are not present, further isolate the problem by plumbing the purge gas directly into the Eclipse front panel, bypassing the sparger. Rerun the profile.
 - If contaminant peaks are not present, the cause resides in the sparger. Replace or solvent-clean the sparger. Replace the sparger ferrules.
 - If contaminant peaks are still present, call the OI Analytical Customer Support Center for assistance.
 - If contaminant peaks are present, the problem does not reside in the sparge vessel or sparge mount area.
 - Rinse the sample pathway according to Chapter 6, "Rinsing the Sample Pathway" on page 127.
6. If contaminant peaks are present, call the OI Analytical Customer Support Center for assistance.

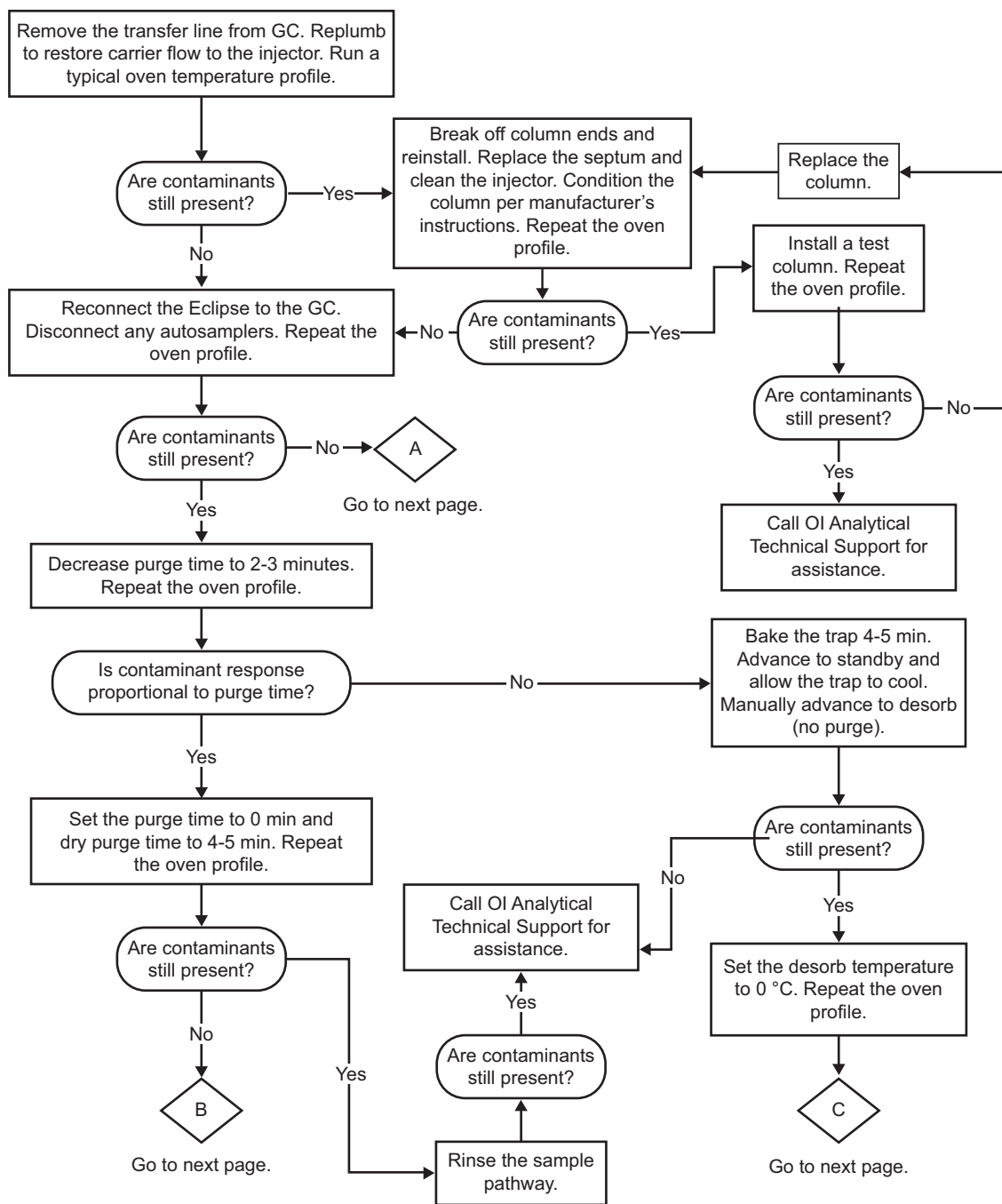

Figure 12.3. Troubleshooting contaminant peaks

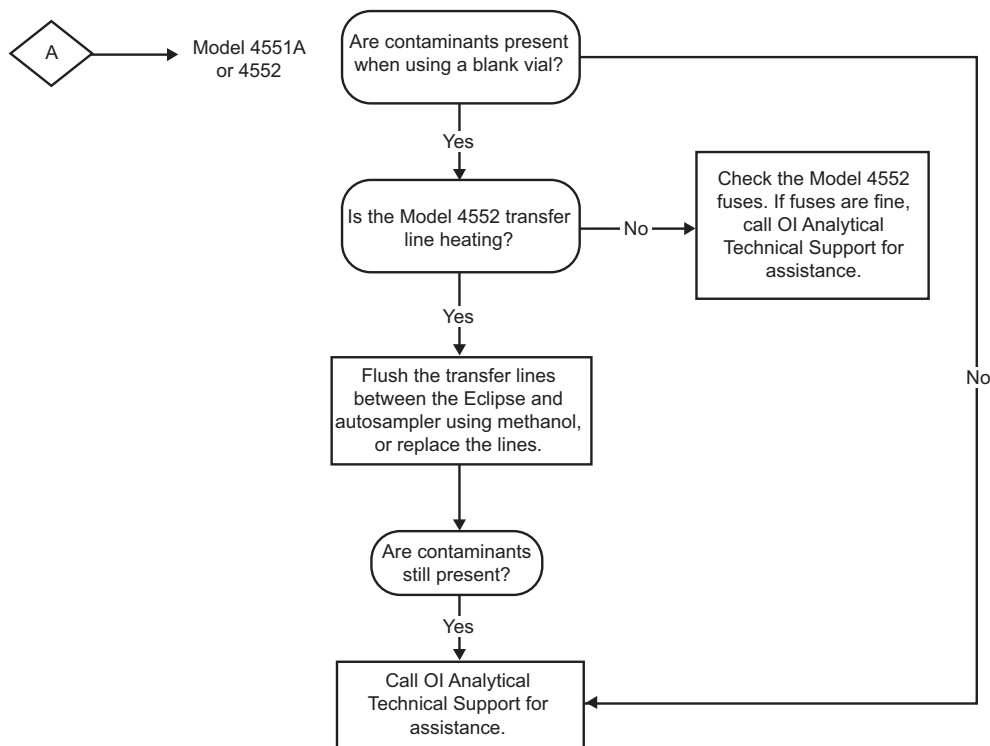
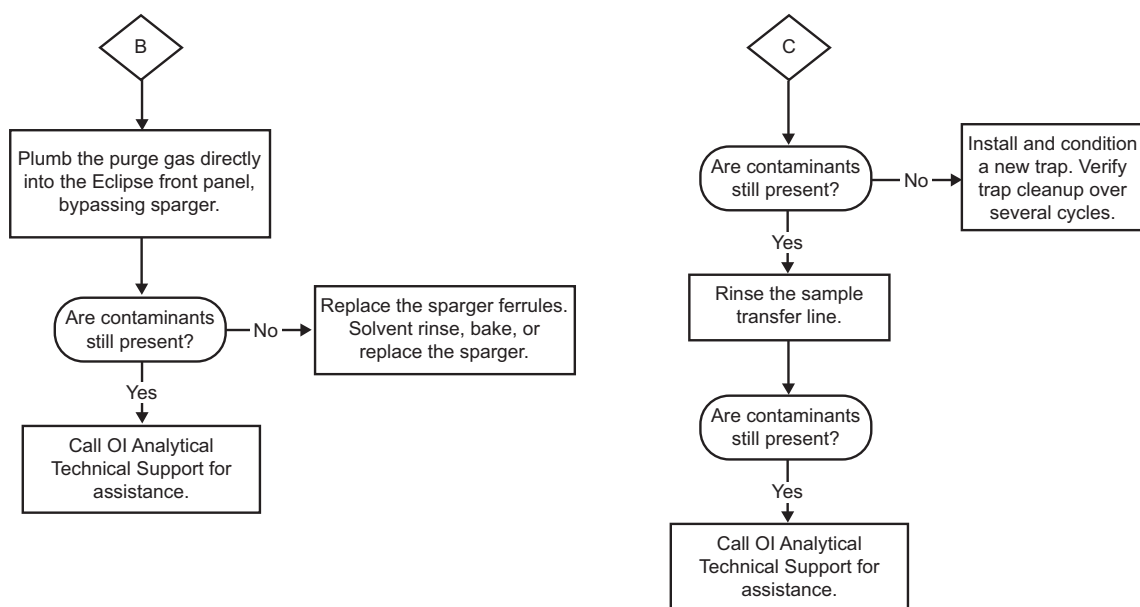

Figure 12.4. Troubleshooting contaminant peaks—continued

**No or Low
Response from
P&T Analysis**

NOTE: For flow diagrams, see Figure 12.5 and Figure 12.6

1. Check the detector response using a direct column injection.
 - If the detector response is incorrect, fix the detector or other chromatography problem.
2. If the detector response is correct, determine the carrier flow at the end of the P&T transfer line during purge and desorb.
 - If the carrier flow is incorrect, call the OI Analytical Customer Support Center for assistance.
3. If the transfer line carrier flow is correct, determine the carrier flow at the end of the column during purge and desorb.
 - If the column carrier flow is incorrect, check the injector for proper installation and septum placement. Inspect the column for breaks and correct as necessary.
4. If the column carrier flow is correct, run an ontrap injection to check the trap.
 - If the ontrap injection response is correct, perform a leak check. If leaks are found, correct as necessary.
 - Check the purge flow. Make adjustments as necessary.
 - Check the purge pressure. Make adjustments as necessary.
 - If the P&T analysis response is still incorrect, call the OI Analytical Customer Support Center for assistance.
5. If the ontrap injection response is incorrect, check the trap.
 - Verify the trap is installed in the right orientation and the proper trap for the application is installed. Correct as necessary.
 - Bake the trap.
 - Verify all heated zones reach the correct temperature.
 - Verify the correct method and times.
6. Spike 5 mL of reagent water with 1 μ L of detector standard. Inject the aqueous standard into the sparge vessel and check if the chromatogram agrees with the direct injection of the same standard.
 - If the response is correct, then the problem is resolved.
7. If the response is not correct, check if the trap reaches the desorb temperature in <15 seconds.
 - If not, call the OI Analytical Customer Support Center for assistance.

8. If the trap response is correct, check if the transfer line is at the proper temperature (110–150 °C).
 - If not, call the OI Analytical Customer Support Center for assistance.
9. If the transfer line temperature is correct, check if more than one inch of transfer line is exposed and unheated.
 - Reposition the heater jacket to minimize exposed areas.
10. Verify the laboratory temperature is <30 °C. Trap efficiency suffers as ambient temperature increases.
11. Verify the air flow to the trap cooling fan and the water management fan are not impeded.
12. If poor P&T response continues, replace and condition a new trap.
13. If poor response persists, including the following specific chromatography issues, rinse the sample pathway as described in Chapter 6, “Rinsing the Sample Pathway” on page 127:
 - Poor recoveries of late eluting or brominated compounds
 - High %RSDs for compounds eluting after the xylenes in an initial calibration, caused by low response on some standards (low response of standards during a calibration can also be caused by a dirty ion source in the MS)
 - Excessive carryover
 - Low response for acrolein or 2-chloroethyl vinyl ether (2-CLEVE)
 - Low response for ketones or alcohols
 - Poor peak shapes, especially for ketones and alcohols
 - Purge pressure above 14 psi
14. If the problem continues, replace the following parts:
 - Line (6-port valve 2 to water management fitting), PN 321048
 - Water management fitting, PN 321596
 - Line (6-port valve 1 to cross 4), PN 321047
 - Line (sparge mount to filter), PN 321932
 - Sample filter, PN 321659
15. If the problem still persists, call the OI Analytical Customer Support Center for assistance.

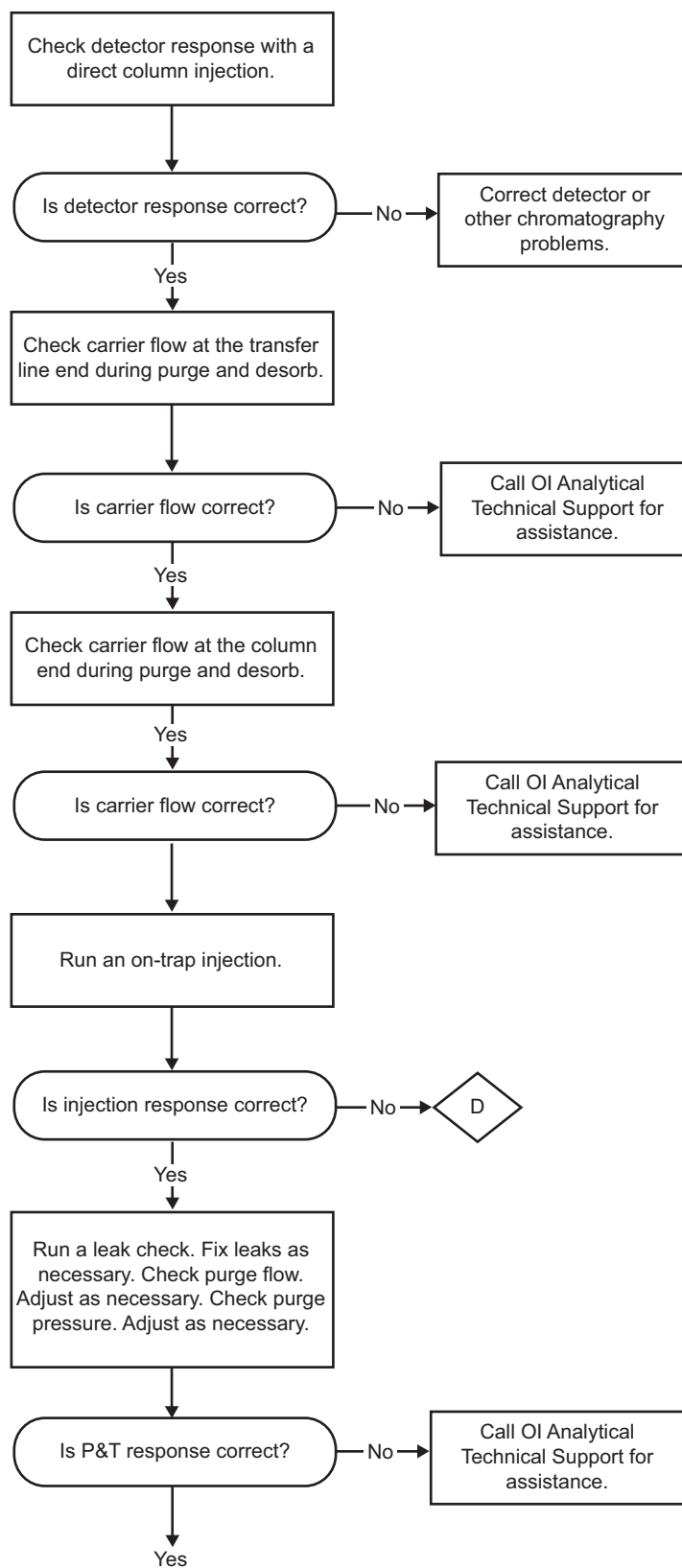

Figure 12.5. Troubleshooting no or low P&T response

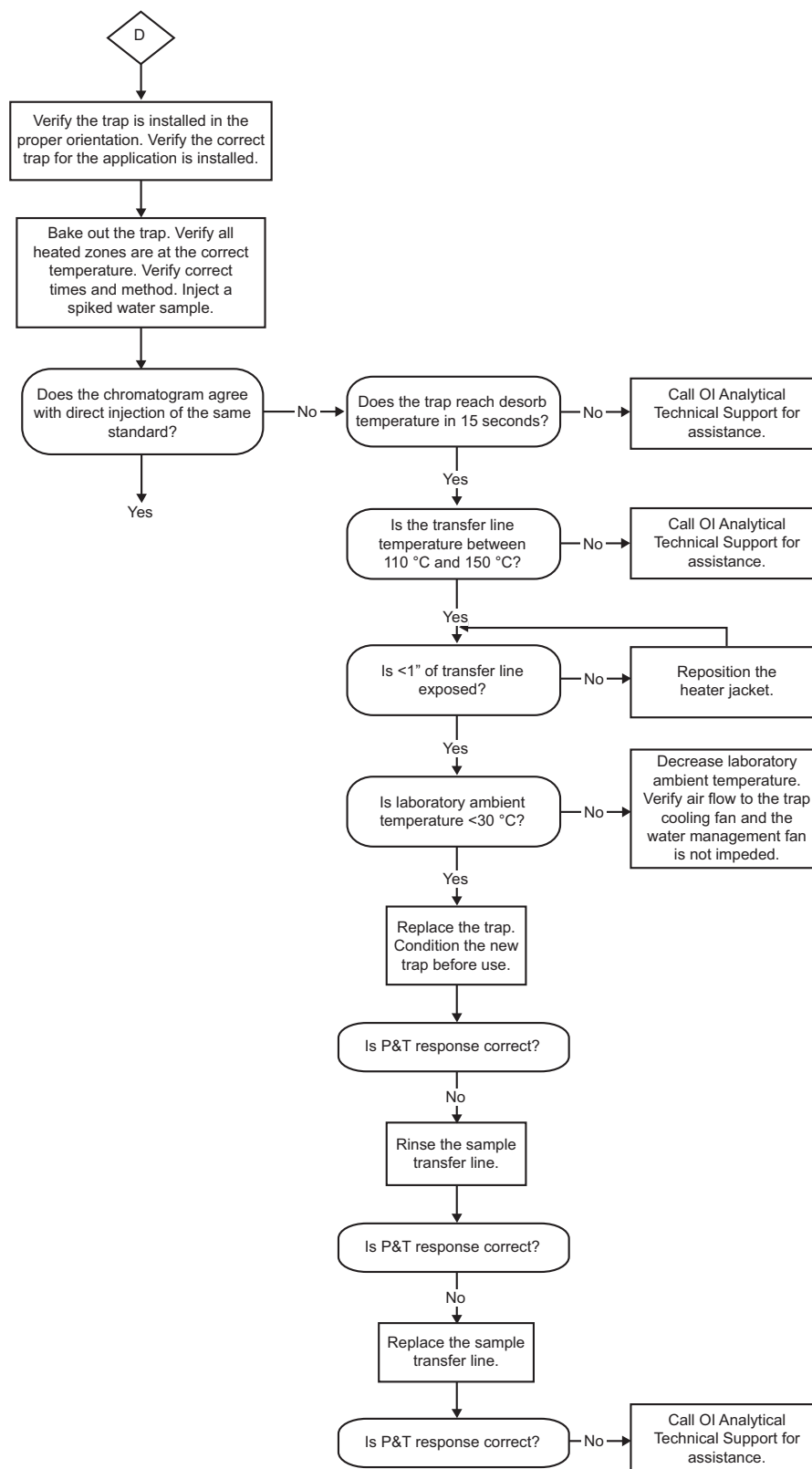

Figure 12.6. Troubleshooting no or low P&T response—continued

Poor Recovery of Low or High Boiling Point Compounds

NOTE: For flow diagrams, see Figure 12.7

1. Run a direct column injection of standards.
 - If the recovery is not good, check and correct any detector or GC problems. If the standards were refrigerated, equilibrate to room temperature before injecting. Obtain a new standard.
2. If recovery from a direct column injection is good, check the trap. Verify the trap is installed in the proper orientation and the correct trap is installed for the application.
3. Verify the laboratory temperature is less than 30 °C. Recoveries of low boiling point compounds suffer as ambient temperature increases. Verify the air flow to the trap cooling fan and the water management fan are not impeded.
4. Check the purge flow is 35–40 mL/minute. High flow rates cause overpenetration of light compounds through the trap. Adjust the flow rate as necessary.
5. Check the desorb times and temperatures. Short desorb times coupled with low desorb flow rates may result in incomplete desorption of high boiling point compounds.
6. Check all heated zone temperatures are set to default and are heating properly.
 - If the temperatures are not being controlled at set points, call the OI Analytical Customer Support Center for assistance.
7. Check the water response.
 - If there is no water response, call the OI Analytical Customer Support Center for assistance.
8. If the water response is excessive, check the trap backpressure. High pressure may indicate contaminants with active sites on the trap.
 - If the trap backpressure is not excessive, call the OI Analytical Customer Support Center for assistance.
 - If the pressure during purge is greater than 15 psi, change the trap.
9. Install the transfer line directly onto the column, bypassing the injector. Check for proper recoveries.
 - If recoveries are correct, check that the injector and the septum are installed properly. Inspect the injector for foreign materials such as septum fragments.
 - If recoveries are still low, call the OI Analytical Customer Support Center for assistance.

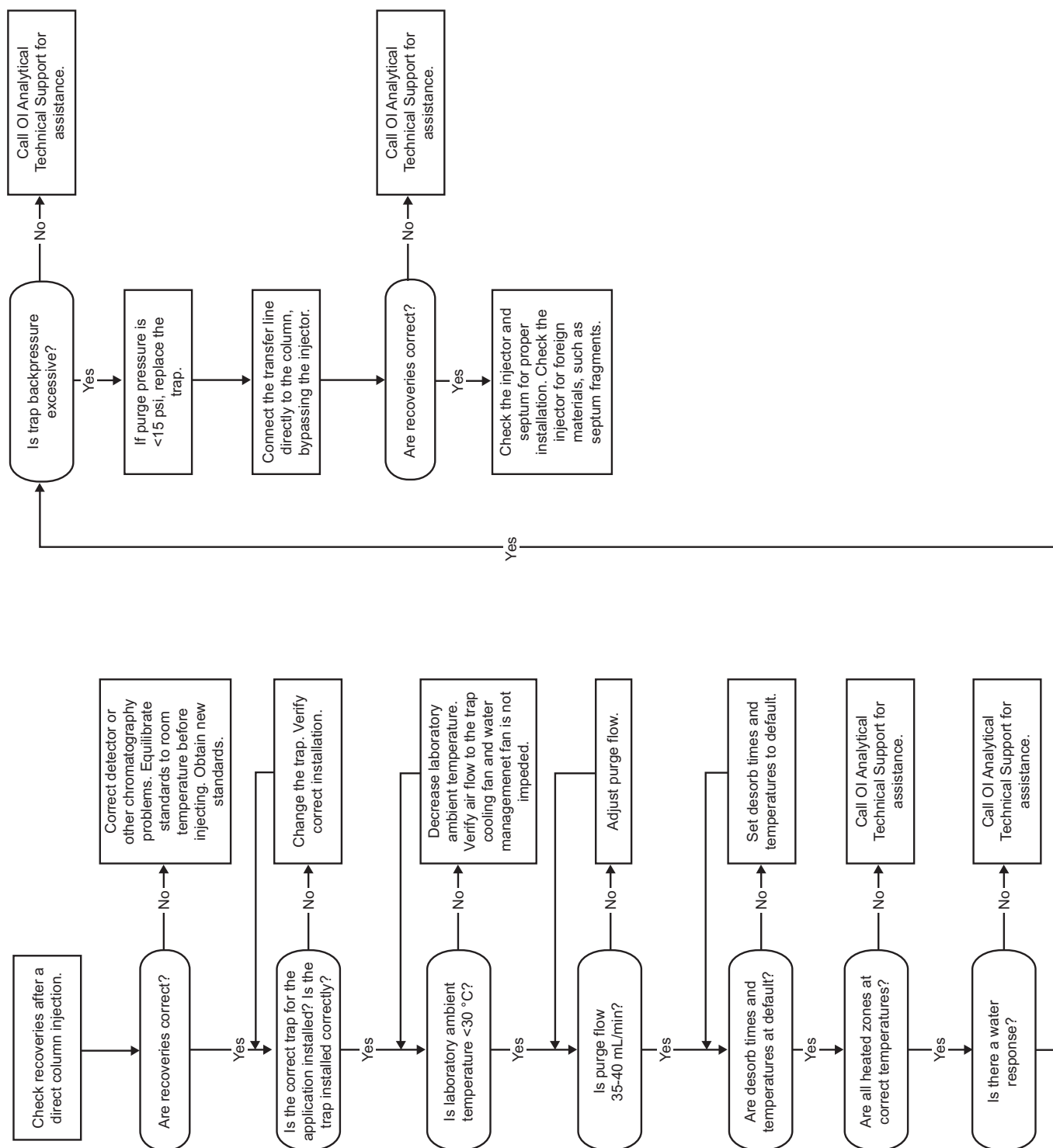

Figure 12.7. Troubleshooting poor recoveries of low or high boiling point compounds



Chapter 13 Recommended Settings and Configurations

Parameter	Recommended Setting or Configuration	Comments
Trap	#10 trap (Tenax/silica gel/ carbon molecular sieve)	The #10 trap provides the best all-around performance for VOC analysis, especially with MS systems. It is designed to work with the WMF to produce the best water management performance and optimum chromatography.
		The #11 VOCARB trap can also be used but some changes to the operating conditions may be necessary.
Trap temperatures	Recommended temperatures for a #10 trap: 20 °C during purge 180 °C during desorb preheat 190 °C during desorb 210 °C during bake	Setting the trap temperature to 20 °C during purge allows it to cool to ambient temperature.
		Laboratory temperatures above ~35 °C hinders optimum cooling and can cause loss of light gases during purge.
Purge time	11 minutes	Required in most USEPA VOC methods.
Purge flow rate	35–40 mL/minute	Helium is the recommended purge gas.
Desorb flow rate	Minimum of 40 mL/minute (when using a 20-m column)	High flow rates minimize lateral diffusion of the analyte band during transfer to the GC column. The high desorb flow rate and rapid transfer to the GC column improve peak shape and height.
Desorb time	0.5–2 minutes	Desorption of 90–100% of all analytes can be achieved with a desorb time of 0.5–1 minute.
		Desorb times of greater than two minutes do not improve recovery and can lead to excessive water transferred to the GC column.
Bake time	5–10 minutes	Baking the trap for 5–10 minutes between analyses is adequate for most applications. However, bake time can be adjusted (longer or shorter) to balance autosampler and GC cycle times.
		An increase in bake temperature or time may be necessary for the Massachusetts VPH method.

Parameter	Recommended Setting or Configuration	Comments
Six-port valve temperature	110–150 °C	Lower temperatures can cause water condensation.
		Higher temperatures can degrade thermally labile compounds.
Transfer line temperature	110–150 °C	Lower temperatures can cause water condensation.
		Higher temperatures can be used, but watch for thermal degradation.
Sample temperature	40–45 °C	Achieve overall optimum performance for most analytes when the sample heats to 40 °–45 °C.
		At lower temperatures (e.g., ambient), polar, water-soluble compounds may have lower purge efficiencies.
		At temperatures above 45 °C, additional water transfers to the trap and may cause performance problems.
Sample size	Water: 5 mL Soil: 5 g	For high concentration discharge or groundwater samples, a 5-mL sample size meets USEPA method guidelines and minimizes the potential for contamination from most samples.
		For very high concentration or contaminated samples, dilution may be necessary.
		For clean drinking water samples, a 25-mL sample size can be used to lower detection limits without fear of contamination. However, because of purge efficiency differences, not all analytes have a five-fold increase in sensitivity.
		Match the sparge vessel to the sample size. Analyzing a 5-mL sample in a 25-mL sparger reduces water carryover to the trap, but this procedure does not follow USEPA protocol specified in most methods and may result in slightly lower recoveries.
		When using the Model 4552 Water/Soil Autosampler, water sample size can be varied from 1–25 mL and dilutions can be done automatically.

Parameter	Recommended Setting or Configuration	Comments
Water management fitting temperatures	110 °C during purge 0 °C during desorb 240 °C during bake	Setting the water management fitting temperature to 0 °C during desorb cools it to ambient temperature and provides the best performance.
		For analyzing some very polar, water-soluble compounds (e.g., California oxygenates method or USEPA Method 1666), using a slightly higher temperature during desorb (e.g., 50 °–70 °C) may improve recovery performance.
Spurge mount temperature (sample inlet)	40–45 °C (50–55 °C when operating with the Foam Buster option)	Cooler temperatures can cause water condensation and loss of brominated compounds and naphthalene.
		Higher temperatures can transfer excessive water to the trap or cause degradation of some thermally labile compounds.
Prepurge	Off	This setting is normally used only with the Air-Tube Desorber Accessory to reduce moisture transferred to the trap.
Preheat	Off	This setting is not necessary when using the Infra-Sparge™ Sample Heater.
Dry purge	Off	This setting is not necessary with a #10 trap.
		For the VOCARB trap, a dry-purge of 1–6 minutes may improve performance but extends the overall cycle time.
Desorb preheat	On, 180 °C (10 °C below the trap desorb temperature)	This function heats the trap to a desired temperature set point prior to the six-port valve rotation (i.e., no carrier gas flow is in line with the trap).
		Desorb preheat is especially useful for analytes such as trichloromonofluoromethane, which may be prone to peak splitting.
		Desorb preheat temperatures that are too high can introduce chromatography problems such as tailing.

Parameter	Recommended Setting or Configuration	Comments
Transfer line/GC inlet interface	As short as possible; insulated	Make the connection as short as possible, ~1.5 inches. Insulate it to minimize water condensation.
		<i>DO NOT</i> leave a 2–3 inch, noninsulated connection as recommended by other P&T manufacturers. This type of connection creates a cold spot and is intended to compensate for the lack of adequate water management.
		Use inlet temperatures of 150 °–220 °C.
Split ratio	40:1 or higher, up to 300:1 when using a 20-m capillary GC column	The high split ratio increases desorption flow rate, which improves peak shape and height.
		Desorption time can be shortened.
		Water transfer to the column is minimized.
		Increases in peak height make up for any loss of mass to the column and potential increases in MDLs.
		A 40:1 split works for a calibration range of ~0.5–100 ppb (5-mL sample size).
		A 300:1 split works for a calibration range of ~10–200 ppb (5-mL sample size).
		For drinking water analysis, use a 25-mL sample size and a 40:1 split ratio for the lowest detection limits.
Inlet liner	1-mm I.D. straight tube liner	Use the smallest I.D. liner available. A 1-mm I.D. liner is best.
		The liner minimizes lateral diffusion of the sample band and maintains peak shape during transfer to the column.

Parameter	Recommended Setting or Configuration	Comments
GC column dimensions	20-m length x 0.18-mm I.D. x 1- μ m film thickness	Most major column manufacturers (e.g., Agilent, Restek) have columns in these dimensions with phases specifically designed for VOC analysis. There are some specific differences in the phases. Contact the column manufacturer for recommended GC programs.
		Dimensions are suitable for MS analysis only. Conventional detectors (PID, ELCD, etc.) have different requirements.
		Results in the shortest overall cycle time when running dual P&T systems.
pHDetect™	To enable sample pH measurement, select Record Sample pH in the Active Method screen. Select Enable pH Sensor in the Options Configure screen.	—
Foam Buster™	See Chapter 4, “Options Configure Screen” on page 71 for recommended settings.	—
Foam Sensor™	See Chapter 4, “Options Configure Screen” on page 71 for recommended settings.	—
SOS™	See Chapter 4, “Options Configure Screen” on page 71 for recommended settings.	—



Chapter 14 Connecting the Eclipse to a Network

Set up network communication to the Eclipse using the optional Eclipse PC software. Choose one of the following setup configurations:

- Single instrument on an isolated network
- Multiple instruments on an isolated network
- Multiple instruments on a site LAN using static IP addresses
- Multiple instruments on a site LAN using dynamic IP addresses
- Setting up an Eclipse PC Unit

Setup of a Single Instrument: Isolated Network

The following figure depicts the configuration to an isolated network. Set the subnet mask to 255.255.255.0 for all instruments connected to the hub.

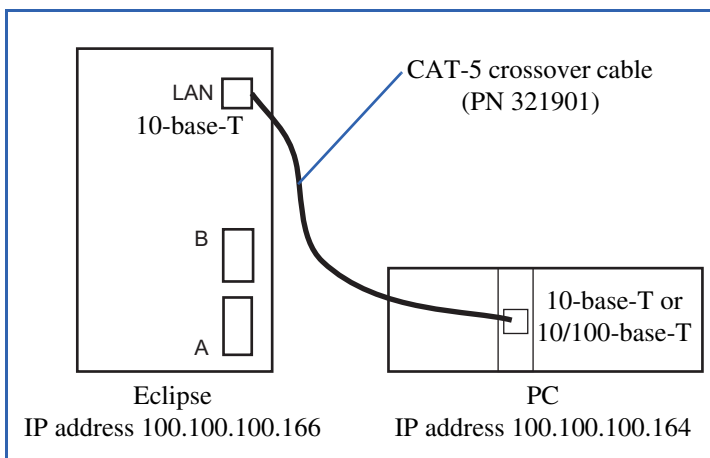

Figure 14.1. Communication cabling directly to a PC with optional Eclipse PC software.

NOTE: If the PC is 100-base-T or 100/1000-base-T only, connect it to the Eclipse through a hub as shown in Figure 14.5.

Assigning IP Addresses

The Eclipse factory default configuration follows:

- IP address: 100.100.100.166
- Subnet mask: 255.255.255.0
- Gateway address: 100.100.100.10

For an isolated instrument network, the first three numbers in the IP address must be the same. A typical configuration follows:

- PC IP address: 100.100.100.164
- Eclipse 1 IP address: 100.100.100.166
- Subnet mask: 255.255.255.0

The subnet mask must be the same for the PC and all instruments.

Configuring TCP/IP on the PC

NOTE: Perform the following steps if configuring the Eclipse for an isolated network. See Figure 14.1 on page 207 and Figure 14.5 on page 212.

Access the TCP/IP Properties Dialog Box

Access the TCP/IP Properties dialog box from the Control Panel of the PC. Accessing this dialog box varies depending on the Windows version:

- Windows NT**
1. Go to the **Start** button, point to **Settings**, and click **Control Panel**.
 2. In the Control Panel, double-click **Network**.
 3. In the Network Control Panel, click the **Protocol** tab.
 4. In the Network Control Panel, select **TCP/IP**.
 5. In the TCP/IP window, click **Properties**.
 6. Click the **IP Address** tab.
 7. Select the **Specify an IP address** option.
 8. Proceed to “Assign the IP Address and Subnet Mask” on page 209.
- Windows 2000**
1. Go to the **Start** button, point to **Settings**, and click **Control Panel**.
 2. Double-click **Network and Dial-up Connections**.
 3. Right-click the appropriate network connection and click **Properties**.
 4. In the “Components checked are used by this connection” box, click **Internet Protocol (TCP/IP)** and click **Properties**. The TCP/IP Properties dialog box appears.
 5. Proceed to “Assign the IP Address and Subnet Mask” on page 209.

- Windows XP**
1. Go to the Control Panel:
 - Go to the **Start** button and click **Control Panel**, or
 - Go to the **Start** button, point to **Settings**, and click **Control Panel**.
 2. Go to the Network Connections:
 - Double-click the **Network Connections** icon, or
 - Click **Network and Internet Connections** followed by **Network Connections**).
 3. Right-click the appropriate network connection and click **Properties**.
 4. Under the General tab, click the entry for **Internet Protocol (TCP/IP)** and click the **Properties** button. The TCP/IP Properties dialog box appears (see Figure 14.2).

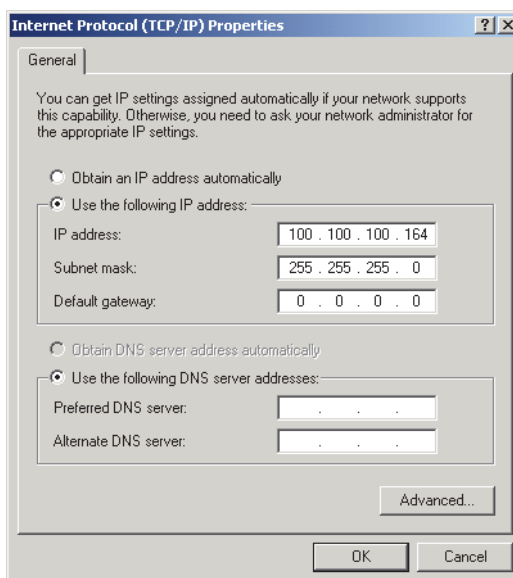

Figure 14.2. TCP/IP Properties dialog box using static addresses

5. Proceed to “Assign the IP Address and Subnet Mask” on page 209.

Assign the IP Address and Subnet Mask

1. Enter the IP address and subnet mask being used for the instrument network. Assigning a gateway is not required when configuring the Eclipse for an isolated network.
2. Click OK and/or Close until all windows have been exited.
3. If using Windows 2000, restart the computer.

Configuring the Eclipse Connection

After installing the Eclipse software, configure the Eclipse connection.

1. Double-click the **Eclipse 4660 LaunchPad** icon or select **LaunchPad** from the Windows Start menu.
2. Select the Eclipse icon and click **Modify**. The Modify 4660 P&T Connection dialog box appears (Figure 14.10).

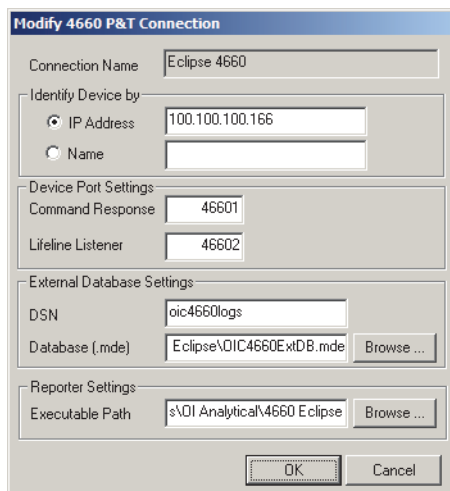

Figure 14.3. Modify 4660 P&T Connection dialog box

3. Use the static IP address to identify the Eclipse. The default IP address is 100.100.100.166.
4. Under Device Port Settings, enter the following values:
 - Command Response: 46601
 - Lifeline Listener: 46602
5. Under Reporter Settings, use the following Executable Path:
C:\Program Files\OI Analytical\4660 Eclipse
6. After entering the information, click **OK** to complete the configuration.
7. Verify a correct configuration by double-clicking the instrument's icon. If communication is established, the Eclipse 4660 Login dialog box appears (see Figure 3.4). If unable to initialize, an error message displays.

NOTE: Ensure the Eclipse properly connects either to the network or directly to the PC and that the power to the Eclipse is on. See Chapter 12, “Using the PING Diagnostic” on page 188.

8. Set up a new user ID. See Chapter 3, “Setting Up a New User ID” on page 24.

Modifying Eclipse Network Settings

The default Eclipse IP address is 100.100.100.166 with the gateway set to 100.100.100.10 and the subnet mask at 255.255.255.0. If necessary, use the following steps to modify the network settings.

NOTE: For Eclipse PC Units, please refer to “Setup of an Eclipse PC Unit” on page 224 for detailed instructions.

1. Start up the Eclipse.
2. From the Status screen, press the **Config** icon. Access the System screen by pressing the **System** tab. For detailed information on the Eclipse user interface, see Chapter 4, “Eclipse User Interface” on page 44.
3. From the System screen, press **Network Settings**. The Network Settings dialog box appears (Figure 14.4).

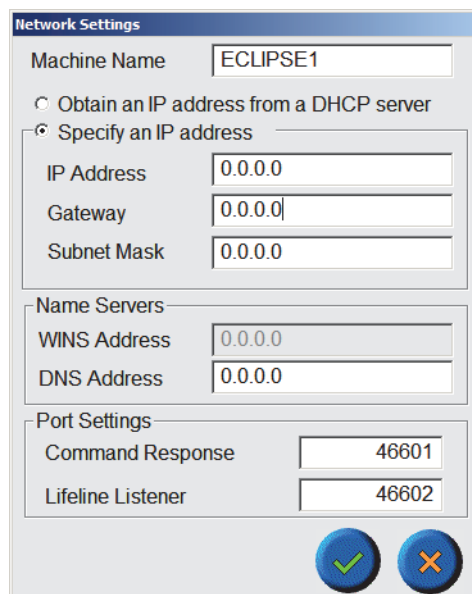

Figure 14.4. Network Settings dialog box

4. Select **Specify an IP address** and enter the appropriate information. Press ?to save the changes or ?to exit the screen without saving the changes.
5. Turn the Eclipse power off and on to implement the new settings.

Setup of Multiple Instruments: Isolated Network

The following figure depicts the configuration to an isolated network using a hub and standard Ethertwist cables. Make hub connections to any combination of ports. Set the subnet mask to 255.255.255.0 for all instruments connected to the hub.

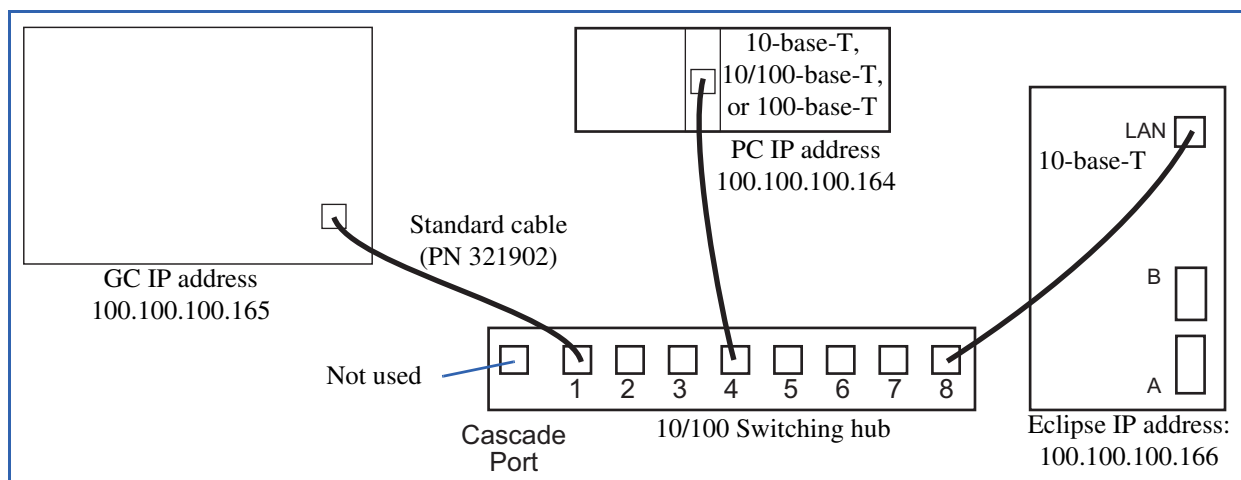

Figure 14.5. Communication cabling configuration to an isolated network

Assigning IP Addresses

The Eclipse factory default configuration follows:

- IP address: 100.100.100.166
- Subnet mask: 255.255.255.0
- Gateway address: 100.100.100.10

For a local instrument network, the first three numbers in the IP address must be the same. A typical configuration follows:

- PC IP address: 100.100.100.164
- Eclipse1 IP address: 100.100.100.166
- Eclipse 2 IP address: 100.100.100.167
- GC IP address: 100.100.100.165
- Subnet mask: 255.255.255.0

The subnet mask must be the same for the PC and all instruments.

Configuring TCP/IP on the PC

NOTE: Perform the following steps if configuring the Eclipse for an isolated network. See Figure 14.1 on page 207 and Figure 14.5 on page 212.

Access the TCP/IP Properties Dialog Box

Access the TCP/IP Properties dialog box from the Control Panel of the PC. Accessing this dialog box varies depending on the Windows version:

- Windows NT**
1. Go to the **Start** button, point to **Settings**, and click **Control Panel**.
 2. In the Control Panel, double-click **Network**.
 3. In the Network Control Panel, click the **Protocol** tab.
 4. In the Network Control Panel, select **TCP/IP**.
 5. In the TCP/IP window, click **Properties**.
 6. Click the **IP Address** tab.
 7. Select the **Specify an IP address** option.
 8. Proceed to “Assign the IP Address and Subnet Mask” on page 214.
- Windows 2000**
1. Go to the **Start** button, point to **Settings**, and click **Control Panel**.
 2. Double-click **Network and Dial-up Connections**.
 3. Right-click the appropriate network connection and click **Properties**.
 4. In the “Components checked are used by this connection” box, click **Internet Protocol (TCP/IP)** and click **Properties**. The TCP/IP Properties dialog box appears.
 5. Proceed to “Assign the IP Address and Subnet Mask” on page 214.
- Windows XP**
1. Go to the Control Panel:
 - Go to the **Start** button and click **Control Panel**, or
 - Go to the **Start** button, point to **Settings**, and click **Control Panel**.
 2. Go to the Network Connections:
 - Double-click the **Network Connections** icon, or
 - Click **Network and Internet Connections** followed by **Network Connections**).
 3. Right-click the appropriate network connection and click **Properties**.

- Under the General tab, click the entry for **Internet Protocol (TCP/IP)** and click the **Properties** button. The TCP/IP Properties dialog box appears (see Figure 14.2).

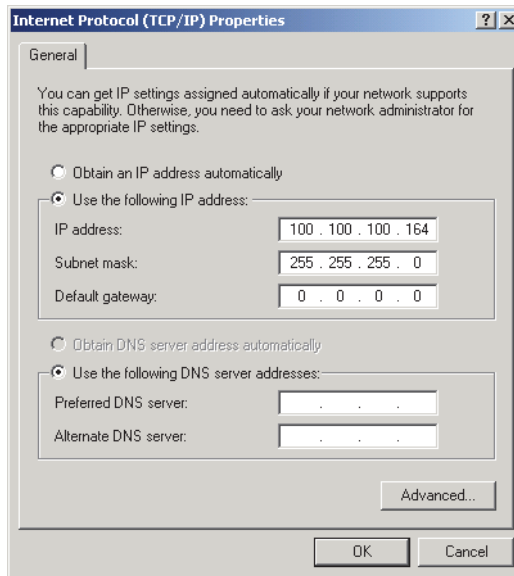

Figure 14.6. TCP/IP Properties dialog box using static addresses

- Proceed to “Assign the IP Address and Subnet Mask” on page 214.

Assign the IP Address and Subnet Mask

- Enter the IP address and subnet mask being used for the instrument network. Assigning a gateway is not required when configuring the Eclipse for an isolated network.
- Click OK and/or Close until all windows have been exited.
- If using Windows 2000, restart the computer.

Configuring the Eclipse Connection

After installing the Eclipse software, configure the Eclipse connection.

- Double-click the **Eclipse 4660 LaunchPad** icon or select **LaunchPad** from the Windows Start menu.
- Click **Add** to add a new Eclipse or select an Eclipse icon and click **Modify**. The Modify 4660 P&T Connection dialog box appears (Figure 14.10).

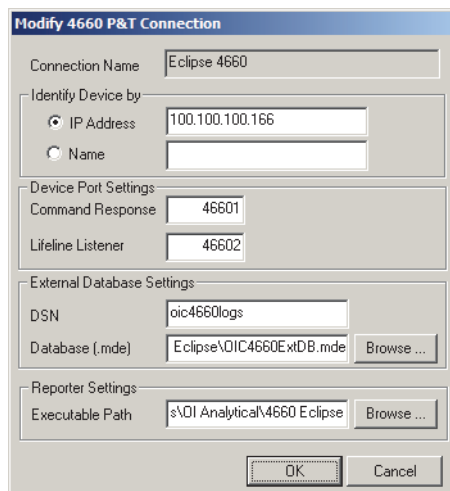

Figure 14.7. Modify 4660 P&T Connection dialog box for an isolated network

3. Use the static IP address to identify the Eclipse. The default IP address is 100.100.100.166.
4. Under Device Port Settings, enter the following values:
 - Command Response: 46601
 - Lifeline Listener: 46602
5. If adding a new Eclipse, change the default database name to distinguish it from the previous Eclipse's database. See Chapter 15, "Creating A New Eclipse Database" on page 224 for more information.
6. Under Reporter Settings, use the following Executable Path:

```
C:\Program Files\OI Analytical\4660 Eclipse
```
7. After entering the information, click **OK** to complete the configuration.
8. Verify a correct configuration by double-clicking the instrument's icon. If communication is established, the Eclipse 4660 Login dialog box appears (see Figure 3.4). If unable to initialize, an error message displays.

NOTE: Ensure the Eclipse properly connects either to the network or directly to the PC and that the power to the Eclipse is on. See Chapter 12, "Using the PING Diagnostic" on page 188.

Modifying Eclipse Network Settings

The default Eclipse IP address is 100.100.100.166 with the gateway set to 100.100.100.10 and the subnet mask at 255.255.255.0. If necessary, use the following steps to modify the network settings.

NOTE: For Eclipse PC Units, please refer to “Setup of an Eclipse PC Unit” on page 224 for detailed instructions.

1. Start up the Eclipse.
2. From the Status screen, press the **Config** icon. Access the System screen by pressing the **System** tab. For detailed information on the Eclipse user interface, see Chapter 4, “Eclipse User Interface” on page 44.
3. From the System screen, press **Network Settings**. The Network Settings dialog box appears (Figure 14.11).

The screenshot shows the 'Network Settings' dialog box. The 'Machine Name' field is set to 'ECLIPSE1'. Under the 'Specify an IP address' section, the IP Address, Gateway, and Subnet Mask fields are all set to '0.0.0.0'. The 'Name Servers' section shows WINS Address and DNS Address both set to '0.0.0.0'. The 'Port Settings' section shows Command Response set to 46601 and Lifeline Listener set to 46602. There are two buttons at the bottom right: a green checkmark and a red X.

Figure 14.8. Network Settings dialog box for an isolated network

4. If using static IP addresses, select **Specify an IP address** and enter the appropriate information. Press ?to save the changes or ?to exit the screen without saving the changes.
5. Turn the Eclipse power off and on to implement the new settings.

Setup of Multiple Instruments: Site LAN Using Static IP Addresses

The following figure depicts the configuration to a site LAN using a hub cascade port. Make hub connections to any combination of ports. Information technology (IT) personnel provide the IP addresses, subnet mask, and gateway for the PC and each instrument on the network. Port 8 and cascade are mutually exclusive.

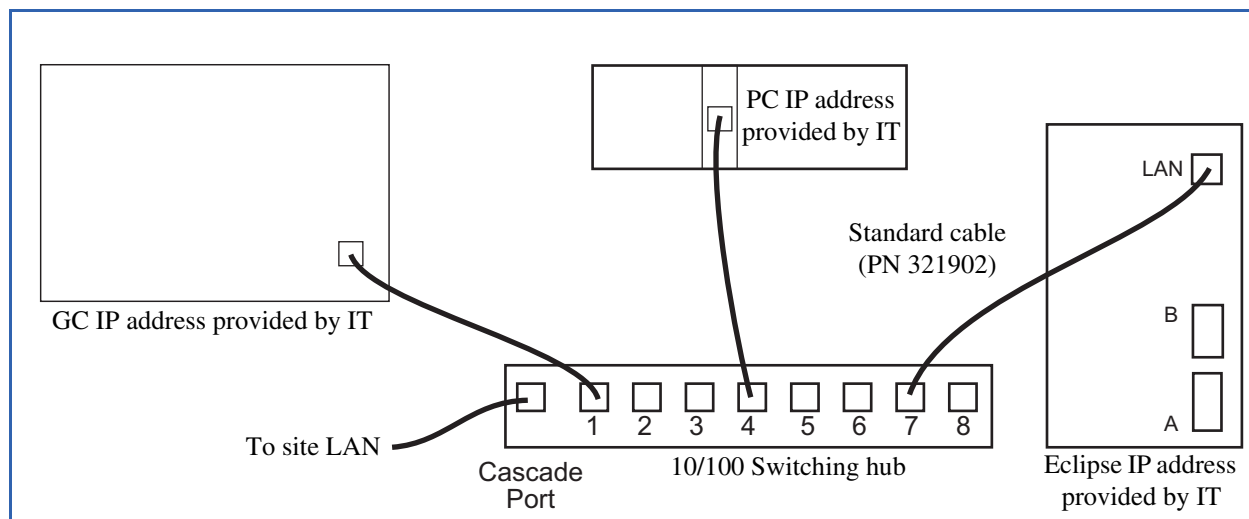

Figure 14.9. Communication cabling configuration to a site LAN

NOTE: If interfacing the instruments and PCs to a site LAN, the installation must be overseen by IT personnel. The IT department provides the LAN connection and IP addresses. The Eclipse network can be isolated from the site LAN by disconnecting the cascade connection.

Assigning IP Addresses

If connecting the Eclipse to a site LAN, IT personnel provide the IP addresses, subnet masks, and gateway addresses.

Configuring TCP/IP on the PC

If setting up on a site LAN, IT personnel enter the IP address, subnet mask, and default gateway. Enter the DNS (domain name system) and WINS (Windows internet naming system) addresses if supplied.

Configuring the Eclipse Connection

After installing the Eclipse software, configure the Eclipse connection.

1. Double-click the **Eclipse 4660 LaunchPad** icon or select **LaunchPad** from the Windows Start menu.
2. Click **Add** to add a new Eclipse or select an Eclipse icon and click **Modify**. The Modify 4660 P&T Connection dialog box appears (Figure 14.10).

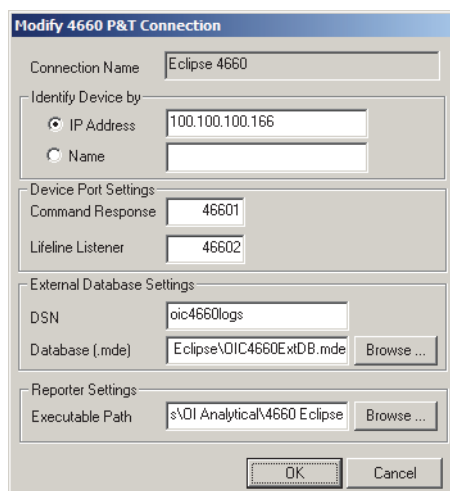

Figure 14.10. Modify 4660 P&T Connection dialog box for static IP addresses

- Use either the static IP address or a name to identify the Eclipse. The default IP address is 100.100.100.166.

NOTE: See “Modifying Eclipse Network Settings” on page 219 in this chapter to change an Eclipse’s IP address.

NOTE: Consult your IT personnel to verify the correct network settings to use. The Eclipse communicates over TCP/IP using either static IP addresses (preferred) or DHCP.

- Under Device Port Settings, enter the following values:
 - Command Response: 46601
 - Lifeline Listener: 46602
- If adding a new Eclipse, change the default database name to distinguish it from the previous Eclipse’s database. See Chapter 15, “Creating A New Eclipse Database” on page 224 for more information.
- Under Reporter Settings, use the following Executable Path:
C:\Program Files\OI Analytical\4660 Eclipse
- After entering the information, click **OK** to complete the configuration.
- Verify a correct configuration by double-clicking the instrument’s icon. If communication is established, the Eclipse 4660 Login dialog box appears (see Figure 3.4). If unable to initialize, an error message displays.

NOTE: Ensure the Eclipse properly connects either to the network or directly to the PC and that the power to the Eclipse is on.

- Set up a new user ID. See Chapter 3, “Setting Up a New User ID” on page 24.

Modifying Eclipse Network Settings

The default Eclipse IP address is 100.100.100.166 with the gateway set to 100.100.100.10 and the subnet mask at 255.255.255.0. If connecting the Eclipse to a site LAN, IT personnel provide the IP addresses, subnet masks, and gateway addresses. If necessary, use the following steps to modify the network settings.

NOTE: For Eclipse PC Units, please refer to “Setup of an Eclipse PC Unit” on page 224 for detailed instructions.

1. Start up the Eclipse.
2. From the Status screen, press the **Config** icon. Access the System screen by pressing the **System** tab. For detailed information on the Eclipse user interface, see Chapter 4, “Eclipse User Interface” on page 44.
3. From the System screen, press **Network Settings**. The Network Settings dialog box appears (Figure 14.11).

Figure 14.11. Network Settings dialog box for static IP addresses

4. Select **Specify an IP address** and enter the appropriate information. Press ?to save the changes or ?to exit the screen without saving the changes.
5. Turn the Eclipse power off and on to implement the new settings.

Setup of Multiple Instruments: Site LAN Using Dynamic IP Addresses

The following figure depicts the configuration to a site LAN using a hub cascade port. Make hub connections to any combination of ports. Information technology (IT) personnel provide the connection to the DHCP server. Port 8 and cascade are mutually exclusive.

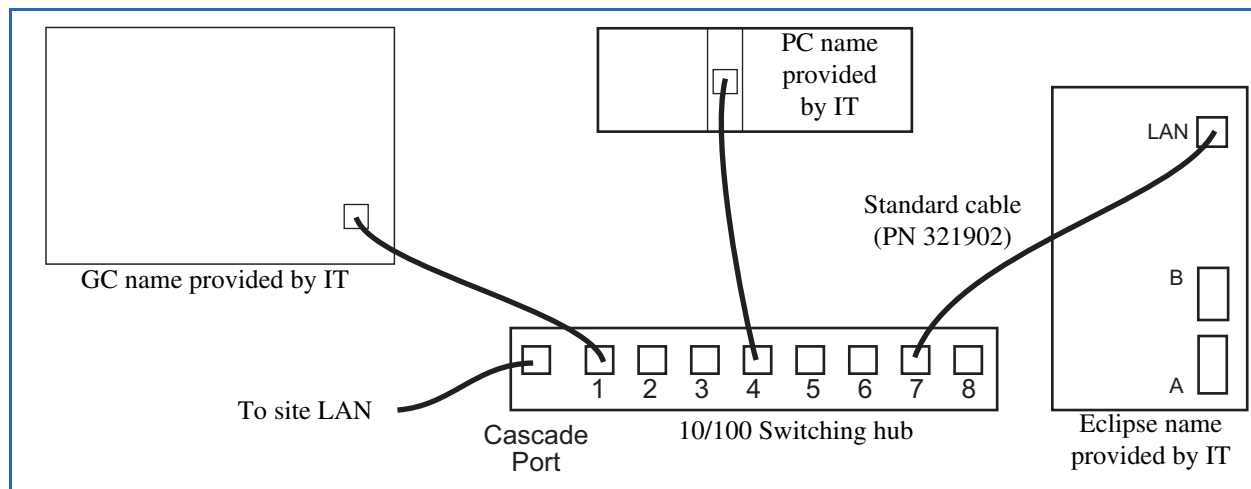

Figure 14.12. Communication cabling configuration to a site LAN

NOTE: If interfacing the instruments and PCs to a site LAN, the installation must be overseen by IT personnel. The IT department provides the LAN connection to the DHCP server.

Configuring TCP/IP on the PC

NOTE: Perform the following steps if configuring the Eclipse for an isolated network. See Figure 14.1 on page 207 and Figure 14.5 on page 212.

Access the TCP/IP Properties Dialog Box

Access the TCP/IP Properties dialog box from the Control Panel of the PC. Accessing this dialog box varies depending on the Windows version:

- Windows NT**
1. Go to the **Start** button, point to **Settings**, and click **Control Panel**.
 2. In the Control Panel, double-click **Network**.
 3. In the Network Control Panel, click the **Protocol** tab.
 4. In the Network Control Panel, select **TCP/IP**.
 5. In the TCP/IP window, click **Properties**.
 6. Click the **IP Address** tab.

7. Select the **Obtain an IP address automatically** option.
8. Proceed to “DNS Settings” on page 222.

Windows 2000

1. Go to the **Start** button, point to **Settings**, and click **Control Panel**.
2. Double-click **Network and Dial-up Connections**.
3. Right-click the appropriate network connection and click **Properties**.
4. In the “Components checked are used by this connection” box, click **Internet Protocol (TCP/IP)** and click **Properties**. The TCP/IP Properties dialog box appears.
5. Proceed to “DNS Settings” on page 222.

Windows XP

1. Go to the Control Panel:
 - Go to the **Start** button and click **Control Panel**, or
 - Go to the **Start** button, point to **Settings**, and click **Control Panel**.
2. Go to the Network Connections:
3. Double-click the **Network Connections** icon, or
 - Click **Network and Internet Connections** followed by **Network Connections**).
4. Right-click the appropriate network connection and click **Properties**.
5. Under the General tab, click the entry for **Internet Protocol (TCP/IP)** and click the **Properties** button. The TCP/IP Properties dialog box appears (see Figure 14.13).

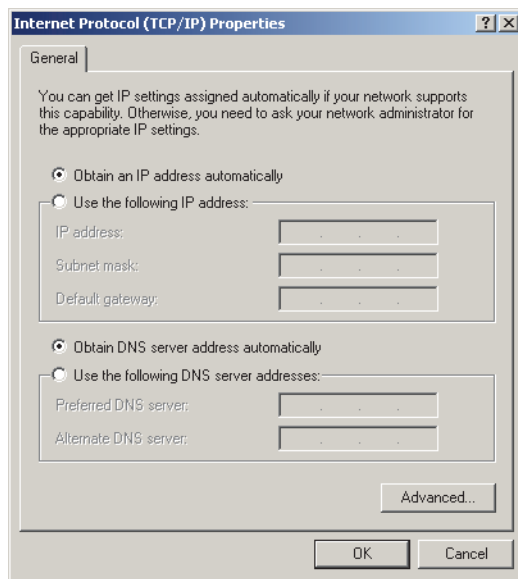

Figure 14.13. TCP/IP Properties dialog box for dynamic IP addresses

6. Proceed to “DNS Settings” on page 222.

DNS Settings

1. Enter the DNS address if supplied.
2. Click OK and/or Close until all windows have been exited.
3. If using Windows 2000, restart the computer.

Configuring the Eclipse Connection

After installing the Eclipse software, configure the Eclipse connection.

1. Double-click the **Eclipse 4660 LaunchPad** icon or select **LaunchPad** from the Windows Start menu.
2. Click **Add** to add a new Eclipse or select an Eclipse icon and click **Modify**. The Modify 4660 P&T Connection dialog box appears (Figure 14.14).

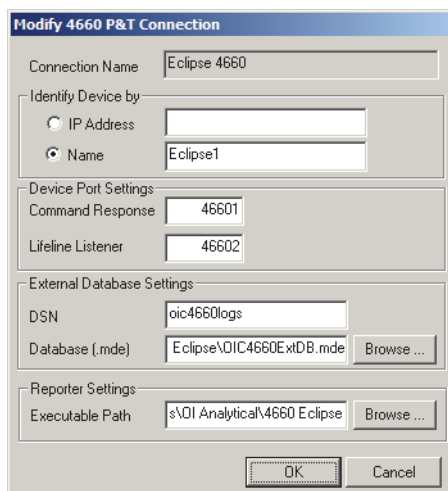

Figure 14.14. Modify 4660 P&T Connection dialog box for dynamic IP addresses

NOTE: Consult your IT personnel to verify the correct network settings to use. The Eclipse communicates over TCP/IP using either static IP addresses (preferred) or DHCP.

3. Under Device Port Settings, enter the following values:
 - Command Response: 46601
 - Lifeline Listener: 46602
4. If adding a new Eclipse, change the default database name to distinguish it from the previous Eclipse's database. See Chapter 15, "Creating A New Eclipse Database" on page 224 for more information.
5. Under Reporter Settings, use the following Executable Path:

```
C:\Program Files\OI Analytical\4660 Eclipse
```
6. After entering the information, click **OK** to complete the configuration.
7. Verify a correct configuration by double-clicking the instrument's icon. If communication is established, the Eclipse 4660 Login dialog box appears (see Figure 3.4). If unable to initialize, an error message displays.

NOTE: Ensure the Eclipse properly connects either to the network or directly to the PC and that the power to the Eclipse is on.

8. Set up a new user ID. See Chapter 3, "Setting Up a New User ID" on page 24.

Modifying Eclipse Network Settings

The default Eclipse IP address is 100.100.100.166 with the gateway set to 100.100.100.10 and the subnet mask at 255.255.255.0. If connecting the Eclipse to a site LAN, IT personnel provide the instrument name, WINS address, and DNS address. If necessary, use the following steps to modify the network settings.

NOTE: For Eclipse PC Units, please refer to “Setup of an Eclipse PC Unit” on page 224 for detailed instructions.

1. Start up the Eclipse.
2. From the Status screen, press the **Config** icon. Access the System screen by pressing the **System** tab. For detailed information on the Eclipse user interface, see Chapter 4, “Eclipse User Interface” on page 44.
3. From the System screen, press **Network Settings**. The Network Settings dialog box appears (Figure 14.15).

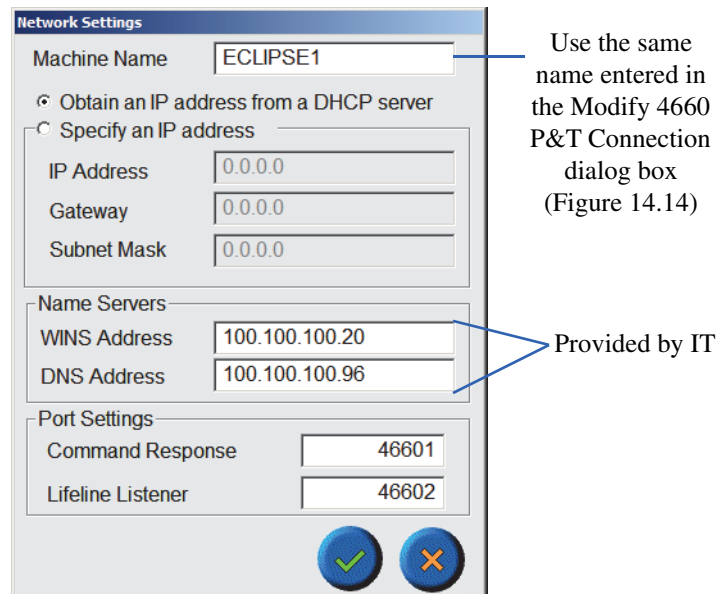

Figure 14.15. Network Settings dialog box for dynamic IP addresses

4. Select **Obtain an IP address from the DHCP server** and enter the IP address of the WINS and DNS servers. Press **?** to save the changes or **X** to exit the screen without saving the changes.
5. Turn the Eclipse power off and on to implement the new settings.

Setup of an Eclipse PC Unit

For a software-controlled Eclipse PC unit (without a touchscreen display), initial communication to the instrument must be established using the default IP address of 100.100.100.166. To connect to the instrument, complete the “Configuring TCP/IP on the PC” and “Configuring the Eclipse Connection” parts of the section applicable to the site configuration (using the default Eclipse IP address):

- “Setup of a Single Instrument: Isolated Network” on page 207
- “Setup of Multiple Instruments: Isolated Network” on page 212

- “Setup of Multiple Instruments: Site LAN Using Static IP Addresses” on page 217

After establishing the connection to the unit, follow the “Modifying Eclipse Network Settings” instructions for the appropriate section to modify the unit as necessary:

- “Setup of a Single Instrument: Isolated Network” on page 207
- “Setup of Multiple Instruments: Isolated Network” on page 212
- “Setup of Multiple Instruments: Site LAN Using Static IP Addresses” on page 217
- “Setup of Multiple Instruments: Site LAN Using Dynamic IP Addresses” on page 220



Chapter 15 Creating A New Eclipse Database

If running more than one Eclipse from a single PC, set up separate external database settings for each Eclipse so each log file stores as a different file.

1. Locate the OIC4660ExtDB.mde file. Its usual location is C:\Program Files\OI Analytical\4660 Eclipse.

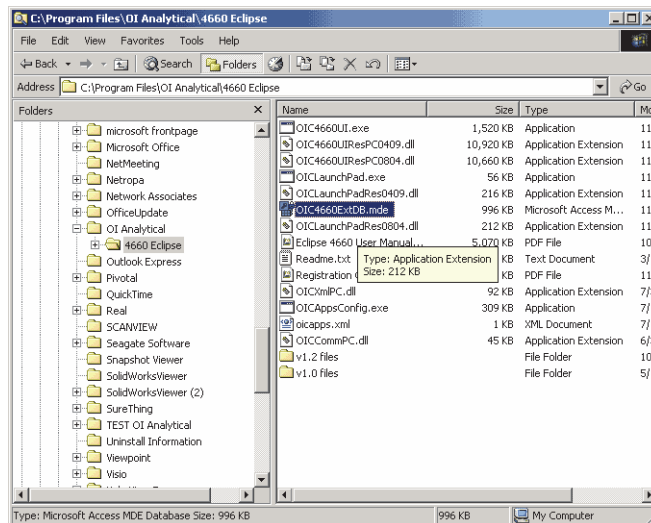

Figure 15.1. Locating the Eclipse .mde file

2. Create a copy of the .mde file and rename the copied file.

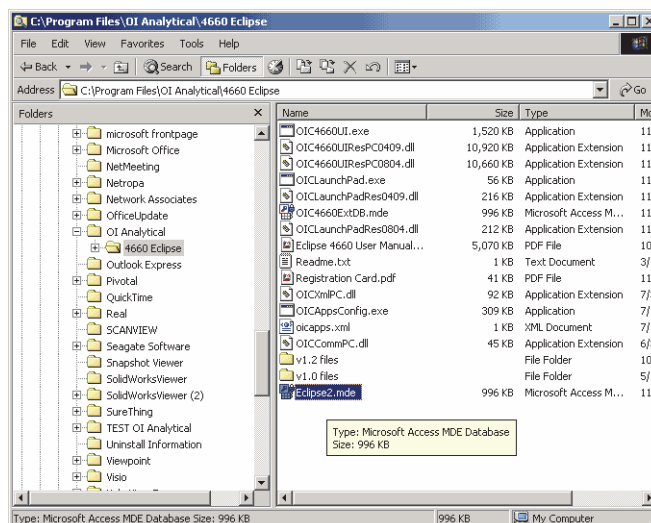

Figure 15.2. Copying of the Eclipse .mde file

- Open the Windows Control Panel by clicking the **Start** button and selecting **Settings → Control Panel**. Double-click **Administrative Tools**.

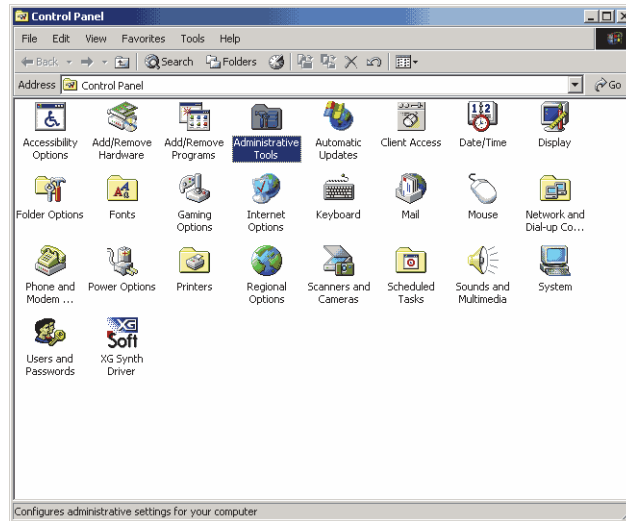

Figure 15.3. Accessing Administrative Tools from the Windows Control Panel

- Double-click **Data Sources (ODBC)** to open the ODBC Data Sources Administrator dialog box. Click the **System DSN** tab.

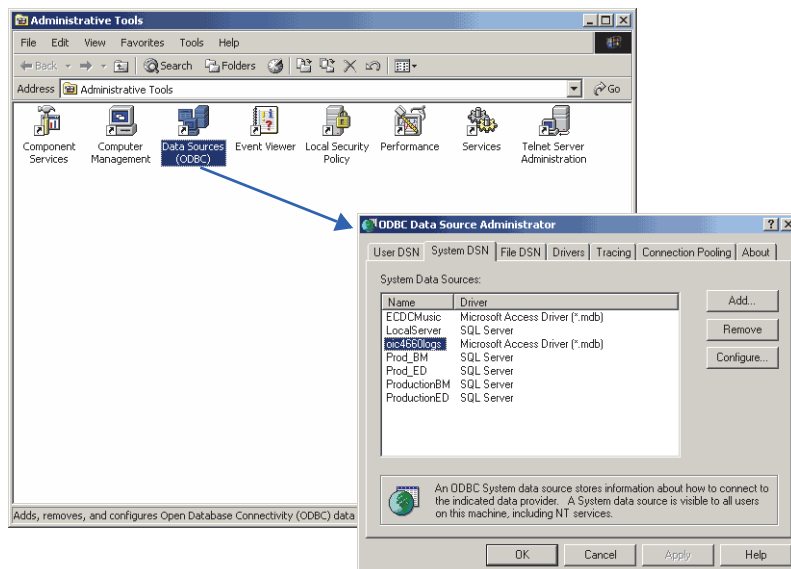

Figure 15.4. Opening the ODBC Data Sources Administrator dialog box

- Click **Add** to open the Create New Data Source dialog box. Select **Microsoft Access Driver (*.mdb)**. Click **Finish**.

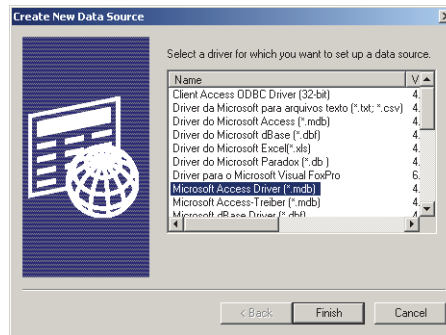

Figure 15.5. Create New Data Source dialog box

- The ODBC Microsoft Access Setup dialog box appears. Enter a new Data Source Name (DSN).

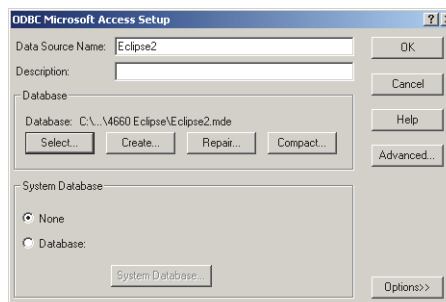

Figure 15.6. ODBC Microsoft Access Setup dialog box

- Click **Select** to open the Select Database dialog box. Under List Files of Type: choose **All Files (*.*)**. Select the newly copied .mde file from step 2. Click **OK**.

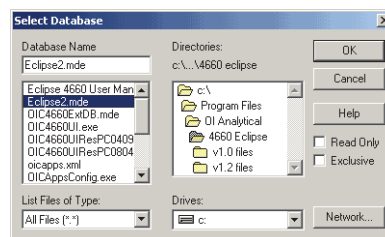

Figure 15.7. Select Database dialog box

- Select **OK** again after returning to the ODBC Microsoft Access Setup dialog box (Figure 15.6).

- The newly created data source name (DSN) appears in the System Data Sources listbox. Click **OK** to exit the ODBC Data Source Administrator dialog box. Close the Control Panel.

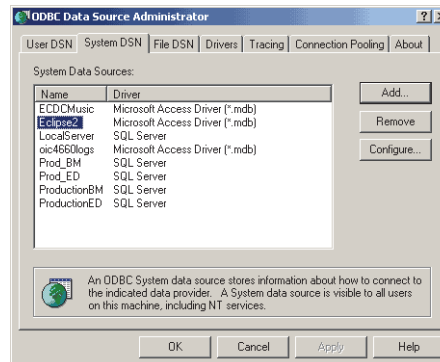

Figure 15.8. The new DSN appears in the System Data Sources listbox

- Open the Eclipse 4660 Launchpad. Click **Add** to add a new Eclipse or select an existing instrument and click **Modify**.

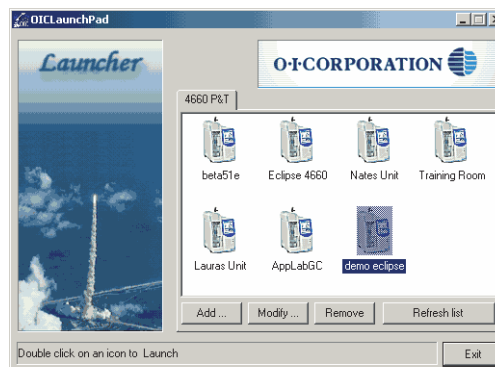

Figure 15.9. OIC LaunchPad screen

11. The Modify 4660 P&T Connections dialog box appears. Enter the data source name (DSN) of the newly created database from step 6.

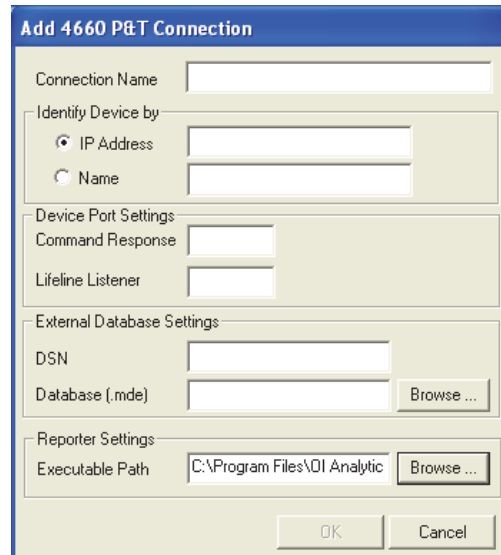

Figure 15.10. Modify 4660 P&T Connections dialog box

12. Click **Browse**. Select the .mde file created in step 2. Click **Open**.

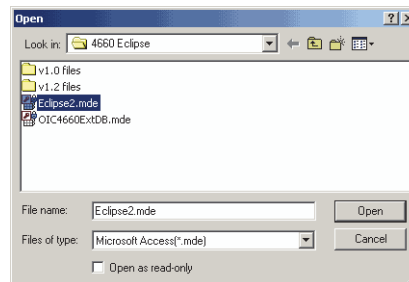

Figure 15.11. Selecting the new database

13. Verify the DSN and Database (.mde) fields are entered appropriately. Click **OK**.

The screenshot shows a dialog box titled "Add 4660 P&T Connection". It contains the following fields and settings:

- Connection Name: Eclipse2
- Identify Device by:
 - IP Address: 100.100.110.40
 - Name: [empty]
- Device Port Settings:
 - Command Response: 46601
 - Lifeline Listener: 46602
- External Database Settings:
 - DSN: Eclipse2
 - Database (.mde): \\4660 Eclipse\Eclipse2.mde (with a "Browse ..." button)
- Reporter Settings:
 - Executable Path: C:\Program Files\OI Analytic (with a "Browse ..." button)

At the bottom of the dialog are "OK" and "Cancel" buttons.

Figure 15.12. Verifying correct DSN and Database settings



Chapter 16 Replacement Parts

This chapter provides a list of replacement parts and support items for the Eclipse Sample Concentrator and its associated options. An asterisk indicates replacement parts that are considered expendable (XPN). Replace expendable parts regularly, since they may become deformed or broken. Keep a supply of expendable parts in stock. See Chapter 17, “Assembly Diagrams” on page 250 for help identifying part numbers.

Eclipse Sample Concentrator Parts

Table 16.1. Assemblies

Product	Unit	PN
DC actuator assembly	each	321175
Fan assembly for Eclipse Trap	each	325878
Fan assembly for Eclipse Water Management	each	325881
I/O board	each	327222-T
Main board with fuses	each	311224
Pressure regulator	each	306886
Pressure transducer assembly	each	320670
Purge gas flow controller	each	228015
SOM board	each	328361
Sparge cover assembly	each	321097
Sparge mount bracket	each	320600
Sparge mount cover assembly	each	321083
Sparge mount manifold, standard (not for Foam Buster option)	each	320581
Trap cover	each	320704
Trap transformer assembly	each	320590
Valve oven cover assembly	each	321586

Table 16.2. External cables

Product	Unit	PN
“H” cable for Agilent 6890N/6850/7890 for starting additional external device on same GC	each	300954
Ethernet cable (Eclipse to network)	each	321902
Ethernet twisted pair cable (Eclipse to PC)	each	321901
Handshake cable for Agilent 5890/4890	each	185868
Handshake cable for Agilent 5970 (RTE-A)	each	209882
Handshake cable for Agilent 5970/5972MS (Pascal)	each	209866
Handshake cable for Agilent 6890N/6890A/6890MS/6850/7890	each	252213
Handshake cable for Eclipse to Model 4552	each	284935
Handshake cable for Model 4552 to Varian 3400/3600	each	251694
Handshake cable for Shimadzu 17A	each	244483
Handshake cable for Thermo Finnigan Trace GC [†]	each	319822
Handshake cable for Varian 3400	each	188409
Handshake cable for Varian 3800/3900	each	300368
Handshake cable to spade lugs	each	285924
Interface cable to Eclipse to Agilent 5890, RTE Agilent 1000 GC/MS software, Agilent 5970 MSD, or Agilent 5988 MS	each	03-505875-00
System interface cable for P&T	each	226530

[†]Must order Thermo Finnigan kit to interface to split/splitless injectors (PN 119245-0001).

Table 16.3. Ferrules and fittings

Product	Size	Unit	PN	XPN
Bulkhead fitting, stainless steel	Q/qy" female x Q/i" male out	each	199513	*
Cable clamp, p-clip, for transfer line strain relief	0.562	each	321169	

Table 16.3. Ferrules and fittings (Continued)

Product	Size	Unit	PN	XPN
Clip fitting for holding stylus to unit	—	each	A303-0709-00	*
Cross fitting, sample filter	Q/qy–Q/i"	each	321658	*
Ferrule, ETFE	Q/qy"	5/pk	322248	*
Ferrule, standard, TFE/glass-filled	18 mm	10/ pk	224352	*
Ferrule, TFE	6-mm tube	each	224337	*
Fitting adapter, brass/nickel	10-32 x Q/ qy" hose	each	202077	*
Fitting and ferrule, flangeless, PEEK and ETFE	Q/qy" x ¼-28 fitting, Q/qy" ferrule	5/pk	322247	*
Nut, brass, female	Q/i	each	128108	*
Nut, extended, stainless steel	Q/qy" male	each	217802	*
Nut, hex, stainless steel, for trap bulkhead	T/qy-20	each	228981	*
Nut, hex, stainless steel, for water management fitting	U/qy-20	each	225474	*
Plug fitting, brass/nickel	10-32 O-ring	each	177502	*
Plug fitting, nickel plated	—	each	217711NI	*
Sample filter assembly	Q/qy–Q/i"	each	321659S	*
Sample filter assembly w/o filter	Q/qy–Q/i"	each	291450S	
Screw, Phillips oval head, stainless steel	4-40 x ¼	each	179457	*
Screw, socket head cap, stainless steel	6-32 x ½	each	197830	*
Screw, socket head cap, stainless steel,	4-40 x E/i"	each	183319	*
Spring clip for drain tube	—	each	321579	
Trap bulkhead fitting	—	each	320580	*
Union, brass, male	¼–Q/qy"	each	227223	*
Union, bulkhead, female, stainless steel	Q/qy"	each	175829	*

Table 16.3. Ferrules and fittings (Continued)

Product	Size	Unit	PN	XPN
Union, stainless steel, female	Q/qy" tube	each	187161	*
Washer, star, external, stainless steel, for trap bulkhead fitting	T/qy"	each	250084	*
Washer, star, external, stainless steel, for water management fitting	U/qy"	each	250092	*
Water management fitting	—	each	321596	*

Table 16.4. Fuses and accessories

Product	Size	Unit	PN	XPN
Fuse holder cap	—	each	320978	
Fuse, 0.80 A, fast-blo	5 x 20 mm	each	320995	*
Fuse, 1.25 A, fast-blo	5 x 20 mm	each	320994	*
Fuse, 1.6 A, fast-blo	5 x 20 mm	each	321749	*
Fuse, 5 A, Slo-Blo, for trap	5 x 20 mm	each	322115	*
Fuse, 5 A, fast-blo	5 x 20 mm	each	321672	*
Fuse, 6.3 A, Slo-Blo	5 x 20 mm	each	249177	*

Table 16.5. Heaters and thermocouples

Product	Unit	PN
Heater and thermocouple assembly for Foam Buster option (not voltage specific)	each	321484
Heater assembly for sparge mount, 115 V	each	320637
Heater assembly for sparge mount, CE, 240 V	each	321953
Heater assembly for valve oven, 115 V	each	321003
Heater assembly for valve oven, CE, 240 V	each	321952
Heater assembly for water management, CE, 240 V	each	321954
Thermocouple assembly for sample heater option	each	321005
Thermocouple assembly for sparge mount	each	321025

Table 16.5. Heaters and thermocouples

Product	Unit	PN
Thermocouple assembly for valve oven	each	321006
Thermocouple assembly for water management	each	321004

Table 16.6. Miscellaneous

Product	Size	Unit	PN	XPN
Eclipse operator's manual and software	—	each	321604	
Eclipse startup kit	—	each	321603	
Interface kit, Eclipse to Model 4552	—	each	321728	
P&T detector standard kit	—	each	222919	
Power cord, 125 V, 10 A for North America	—	each	116038	
Touchscreen stylus	—	each	321585	*
Heated transfer line, blank, 115 V	48"	each	321145	
Heated transfer line, blank, 115 V	60"	each	321146	
Heated transfer line, blank, 230 V	48"	each	321147	
Heated transfer line, blank, 230 V	60"	each	321148	
Needle sparge hardware kit	—	each	321615	

Table 16.7. Modules

Product	Unit	PN
Eclipse electronics module w/ touchscreen, 115 V	each	321091
Eclipse electronics module w/ touchscreen, 230 V	each	321618
Eclipse pneumatics module, 115 V	each	321090
Eclipse pneumatics module, 230 V	each	321619

Table 16.8. Spargers and accessories

Product	Size	Unit	PN	XPN
Ferrule, standard, TFE/glass-filled	18 mm	10/pk	224352	*
Ferrule, TFE	6-mm tube	each	224337	*
Frit sparger, swage inlet	5 mL, 18-mm neck O.D.	each	321478	*
Frit sparger, swage inlet	25 mL, 18-mm neck O.D.	each	321479	*
Frosted frit sparger, swage inlet	5 mL, 18-mm neck O.D.	each	321080	*
Frosted frit sparger, swage inlet	25 mL; 18-mm neck O.D.	each	321081	*
Frosted needle sparger	5 mL	each	321696	*
Frosted needle sparger	25 mL	each	321697	*
Sample needle for frit sparging	—	each	321035	
Sample needle for frit sparging with Foam Buster option	—	each	321475	
Sample needle for needle sparging	—	each	321651	
Sample needle for needle sparging with Foam Buster option	—	each	321700	
Sparger wrench	1Q/i" OE	each	227975	

Table 16.9. Traps

Product	Unit	PN	XPN
#0 Trap, blank (no sorbent)	each	228114	*
#7 Trap, Tenax only	each	227348	*
#8 Trap, Tenax/silica gel	each	227363	*
#9 Trap, Tenax/silica gel/charcoal	each	219972	*
#10 Trap, Tenax/silica gel/carbon molecular sieve	each	228122	*
#11 Trap, VOCARB® 3000	each	258830	*
#12 Trap, BTEX (Carbopack B/Carbopack C)	each	258848	*

Table 16.9. Traps

Product	Unit	PN	XPN
#524.3, for USEPA Method 524.3	each	326720	*

Table 16.10. Tube assemblies and tubing

Product	Size	Unit	PN
Tube assembly for carrier in to six-port valve 4	—	each	321037
Tube assembly for Eclipse six-port valve 1 to cross 4	—	each	321047
Tube assembly for external drain	—	each	321476
Tube assembly for six-port valve 2 to water management fitting	—	each	321048
Tube assembly, cross 1 to valve A	—	each	321101
Tube assembly, sparge mount to filter	—	each	321932
Tube assembly, six-port 5 to trap bulkhead fitting	—	each	321046
Tube assembly, TFE, drain line	—	each	321691
Tube assembly, transfer line	4 feet	each	321692
Tube assembly, transfer line	5 feet	each	321693
Tube assembly, vent plug	—	each	248864
Tubing, copper, cleaned	Q/i x 0.070 I.D.	foot	111427
Tubing, stainless steel	Q/qy x 0.010 I.D.	inch	184986
Tubing, urethane, clear	Q/i x Q/qy" I.D.	foot	166224

Table 16.11. Valves and accessories

Product	Size	Unit	PN
Check valve, brass-nickel, 0.5 psi	10-32	each	321602
Drain valve assembly, 12V	—	each	321010

Table 16.11. Valves and accessories

Product	Size	Unit	PN
Four-way injection valve, KEL-F	—	each	321100
Sample valve mounting bracket	—	each	321079
Six-port valve, stainless steel	Q/qy"	each	321578
Three-way injection valve, KEL-F	¼-28	each	169484
Three-way dry purge valve, stainless steel, Viton, 12 V (B)	—	each	289546
Three-way isolation valve, bake vent and backflush valve (A and C)	—	each	327544
Two-way manifold valve, stainless steel, Viton, 12V, for purge gas (F)	—	each	315234
Valve manifold assembly	—	each	321174

Foam Buster Option Replacement Parts

Table 16.12. Foam Buster replacement parts

Product	Size	Unit	PN	XPN
Block for Foam Buster Option	—	each	321125	
Ferrule, ETFE,	Q/qy"	each	322248	*
Ferrule, Tefzel, flangeless	3 mm	each	321678	*
Ferrule, TFE	Q/qy" tube	each	177626	*
Ferrule, TFE	6-mm tube	each	224337	*
Fitting nut for Foam Buster Option, PEEK	Q/qy x ¼-28	each	322237	*
Fitting, stainless steel for Foam Buster heater	¼-28 x 8 x 0.7	each	321469	*
Heater/sensor assembly for Foam Buster Option	—	each	321484	
Sample needle for frit sparging w/ Foam Buster Option	—	each	321475	
Sample needle for needle sparging w/ Foam Buster Option	—	each	321700	
Screw set SOC stainless steel, CUP	4-40 x Q/i"	each	131953	*

Table 16.12. Foam Buster replacement parts

Product	Size	Unit	PN	XPN
Sparge mount manifold for Foam Buster Option	—	each	320724	
Fitting and ferrule for Foam Buster needle ¹	Q/qy" x ¼-28	set	322248	*

¹ Replaces the stainless steel and Cheminert ferrule on units shipped prior to May 17, 2004.

Infra-Sparge™ Option Replacement Parts

Table 16.13. Infra-Sparge™ Sample Heater

Product	Unit	PN
Door interlock magnetic cable	each	321134
Infra-Sparge™ lamp for Eclipse, 120 V, 300 W	each	321451
Infra-Sparge™ lamp for Eclipse, 230 V, 250 W	each	321452
Lamp cover assembly w/ filter	each	321736
Sample thermocouple assembly	each	321005
Sockets	2/pk	225664
Visible light filter	each	227173

pHDetect™ Module Replacement Parts

Table 16.14. pHDetect™ replacement parts

Product	Size	Unit	PN	XPN
Air pump assembly	—	each	321681	
Buffer solution - pH 4.01	—	bottle	108700	*
Buffer solution - pH 7.0	—	bottle	108702	*
Cap manifold	—	each	324113	
Ferrule, TFE	½"	each	324124	*
Ferrule, TFE	18 mm	each	224204	*
Fitting nut	—	each	321092	
Fitting - CPVC, reverse	¼-28	each	324084	*

Table 16.14. pHDetect™ replacement parts

Product	Size	Unit	PN	XPN
Fitting - bulkhead PEEK	¼-28 x ¼-28	each	A001493	
Fitting - Nut Peek, Blue, Flangeless	¼-28, Q/i"	each	319345	*
Fitting - Nut Peek, Green, Flangeless	¼-28, Q/i"	each	319347	*
Fitting - Nut Peek, Natural, Flangeless	¼-28, Q/i"	each	319343	*
Fitting - Nut Peek, Red, Flangeless	¼-28, Q/i"	each	319344	*
Nut - knurled	18 mm	each	224675	
O-ring (EPDM replacement for Valve, PN 321908)	—	each	321925	*
PCA - Pressure Transducer	—	each	320670	
PCA - pH Detect	—	each	311257-T	
pH fill/drain manifold assembly	—	each	321162	
pH select manifold assembly	—	each	321163	
Probe - pH Detect	—	each	321685	
Reservoir - pH glass	—	each	324106	
Tubing - Silicone	¼" x Q/i"	foot	323584	*
Tubing - TFE, blue	Q/i" x 0.062" I.D.	foot	319607	*
Tubing - TFE, green	Q/i" x 0.062" I.D.	foot	319606	*
Tubing - TFE, red	Q/i" x 0.062" I.D.	foot	319328	*
Tubing - TFE, wall	Q/i" O.D. x 0.030"	foot	147901	*
Thumbscrew - Stainless Steel	10-32 x 0.375	each	324115	*
Valve - 3-way, 12 V isolation	—	each	326129	

**Sparge Overfill
Sensor (SOS™)
Option
Replacement Parts**

Table 16.15. SOS™ replacement parts

Product	Size	Unit	PN
Bushing, snap	E/i" hole x 0.188" I.D.	each	321170
Compression spring, stainless steel	0.240 x 0.75	each	321580
SOS™ adjustment screwdriver	—	each	321599
SOS™ assembly	—	each	321488
SOS™ shield	—	each	321589
Standoff, brass, female/female	4-40 x 1.00	each	321171
Thumbscrew, brass/nickel	4-40 x ¼	each	230938

Glassware Selection Guide

Sparger	Size	Neck	Eclipse	Model 4551A	Model 4552	Single Piece PN	Kit PN	Units per kit
Frit	5 mL	18 mm	?			321478	—	—
Frit	25 mL	18 mm	?			321479	—	—
Frosted frit	5 mL	—	?			321080	—	—
Frosted frit	25 mL	—	?			321081	—	—
Frosted needle	5 mL	18 mm	?			321696	—	—
Frosted needle	25 mL	18 mm	?			321697	—	—
Disposable	10 mL	18 mm	?			—	199521	125
Vial kit†	40 mL	28 mm		?	?	—	296053	72
Vials	2 mL	—				—	276378	100
Vials	10 mL	—				—	307421	100
Vials	40 mL	28 mm		?		—	296087	72
Soil Vials (double-ended)	—	—			?	03-504099-00	—	6
Wash/waste station vial	—	—		?		232801	—	—

Part Number Lookup Table

PN	Product	Size	Unit	XPN
03-505875-00	Interface cable to Eclipse to Agilent 5890, RTE Agilent 1000 GC/MS software, Agilent 5970 MSD, or Agilent 5988 MS	—	each	
108700	Buffer solution - pH 4.01	—	bottle	*
108702	Buffer solution - pH 7.0	—	bottle	*
111427	Tubing, copper, cleaned	Q/i x 0.070 I.D.	foot	
116038	Power cord, 125 V 10 A for North America	—	each	
128108	Nut, brass, female	Q/i	each	*
147901	Tubing - TFE, wall	Q/i" O.D. x 0.030"	foot	*
131953	Screw set SOC stainless steel, CUP	4-40 x Q/i"	each	*
166224	Tubing, urethane, clear	Q/i x Q/qy" I.D.	foot	
169484	Three-way injection valve, KEL-F	¼-28	each	
175829	Union, bulkhead, female, stainless steel	Q/qy"	each	*
177502	Plug fitting, brass/nickel	10-32 O-ring	each	*
177626	Ferrule, TFE	Q/qy" tube	each	*
179457	Screw, Phillips oval head, stainless steel	4-40 x ¼"	each	*
183319	Screw, socket head cap, stainless steel,	4-40 x E/i"	each	*
184986	Tubing, stainless steel	Q/qy" x 0.010 I.D.	inch	
185868	Handshake cable for Agilent 5890/4890	—	each	
187161	Union, stainless steel, female	Q/qy" tube	each	*

PN	Product	Size	Unit	XPN
188409	Handshake cable for Varian 3400	—	each	
197830	Screw, socket head cap, stainless steel	6-32 x 1/2"	each	*
199513	Bulkhead fitting, stainless steel	Q/qy" female x Q/i" male out	each	*
202077	Fitting adapter, brass/nickel	10-32 x Q/ qy" hose	each	*
209866	Handshake cable for Agilent 5970/ 5972MS (Pascal)	—	each	
209882	Handshake cable for Agilent 5970 (RTE-A)	—	each	
217802	Nut, extended, stainless steel	Q/qy" male	each	*
219972	#9 Trap, Tenax/silica gel/charcoal	—	each	*
222919	P&T detector standard kit	—	each	
224204	Ferrule, TFE	18 mm	each	*
224337	Ferrule, TFE	6-mm tube	each	*
224337	Ferrule, TFE	6-mm tube	each	*
224337	Ferrule, TFE	6-mm tube	each	*
224352	Ferrule, standard, TFE/glass-filled	18 mm	10/ pk	*
224352	Ferrule, standard, TFE/glass-filled	18 mm	10/ pk	*
225474	Nut, hex, stainless steel, for water management fitting	U/qy"-20	each	*
225664	Sockets	—	2/pk	
224675	Nut - knurled	18 mm	each	
226530	System interface cable for P&T	—	each	
227173	Visible light filter	—	each	
227223	Union, brass, male	1/4-Q/qy"	each	*
227348	#7 Trap, Tenax only	—	each	*
227363	#8 Trap, Tenax/silica gel	—	each	*
227975	Sparger wrench	1Q/i" OE	each	

PN	Product	Size	Unit	XPN
228015	Purge gas flow controller	—	each	
228114	#0 Trap, blank (no sorbent)	—	each	*
228122	#10 Trap, Tenax/silica gel/carbon molecular sieve	—	each	*
228981	Nut, hex, stainless steel, for trap bulkhead	Y/qy-20	each	*
230938	Thumbscrew, brass/nickel	4-40 x ¼"	each	
244483	Handshake cable for Shimadzu 17A	—	each	
248864	Tube assembly, vent plug	—	each	
249177	Fuse, 6.3 A, Slo-Blo	5 x 20 mm	each	*
250084	Washer, star, external, stainless steel, for trap bulkhead fitting	T/qy"	each	*
250092	Washer, star, external, stainless steel, for water management fitting	U/qy"	each	*
251694	Handshake cable for Model 4552 to Varian 3400/3600	—	each	
252213	Handshake cable for Agilent 6890N/6890A/6890MS/6850/7890	—	each	
258830	#11 Trap, VOCARB® 3000	—	each	*
258848	#12 Trap, BTEX (Carbopack B/ Carbopack C)	—	each	*
283549	MicroTrap™ "A" Carboxen 1000 replacement trap	—	each	*
284935	Handshake cable for Eclipse to Model 4552	—	each	
285924	Handshake cable to spade lugs	—	each	
287649	MicroTrap™ "B" Carbosieve replacement trap	—	each	*
289546	Three-way dry purge valve, stainless steel, Viton, 12 V (B)	—	each	
291211	Fuse, 4 A, Slo-Blo, for trap	5 x 20 mm	each	*
291435	MicroTrap™ "A" Carboxen® 1000 kit	—	each	*

PN	Product	Size	Unit	XPN
291443	MicroTrap™ “B” Carbosieve kit	—	each	*
291450S	Sample filter assembly w/o filter	Q/qy–Q/i"	each	
300368	Handshake cable for Varian 3800/ 3900	—	each	
300954	“H” cable for Agilent 6890N/6850/ 7890 for starting additional external device on same GC	—	each	
306886	Pressure regulator	—	each	
311224	Main board with fuses	—	each	
311257-T	PCA - pH Detect	—	each	
315234	Two-way manifold valve, stainless steel, Viton, 12V, for purge gas (F)	—	each	
319328	Tubing - TFE, red	Q/i" x 0.062" I.D.	foot	*
319343	Fitting - Nut Peek, Natural, Flangeless	¼-28, Q/i"	each	*
319344	Fitting - Nut Peek, Red, Flangeless	¼-28, Q/i"	each	*
319345	Fitting - Nut Peek, Blue, Flangeless	¼-28, Q/i"	each	*
319347	Fitting - Nut Peek, Green, Flangeless	¼-28, Q/i"	each	*
319606	Tubing - TFE, green	Q/i" x 0.062" I.D.	foot	*
319607	Tubing - TFE, blue	Q/i" x 0.062" I.D.	foot	*
319822	Handshake cable for Thermo Finnigan Trace GC†	—	each	
320580	Trap bulkhead fitting	—	each	*
320581	Sparge mount manifold, standard (not for Foam Buster Option)	—	each	
320590	Trap transformer assembly	—	each	
320600	Sparge mount bracket	—	each	
320637	Heater assembly for sparge mount, 115 V	—	each	
320670	Pressure transducer assembly	—	each	

PN	Product	Size	Unit	XPN
320704	Trap cover	—	each	
320724	Sparge mount manifold for Foam Buster Option	—	each	
320978	Fuse holder cap	—	each	
320994	Fuse, 1.25 A, fast-blo	5 x 20 mm	each	*
320995	Fuse, 0.80 A, fast-blo	5 x 20 mm	each	*
320996	Fuse, 2.50 A, Slo-Blo	5 x 20 mm	each	*
321003	Heater assembly for valve oven, 115 V	—	each	
321004	Thermocouple assembly for water management	—	each	
321005	Sample thermocouple assembly for sample heater option	—	each	
321006	Thermocouple assembly for valve oven	—	each	
321010	Drain valve assembly, 12V	—	each	
325878	Fan assembly for Eclipse trap	—	each	
325881	Fan assembly for Eclipse water management	—	each	
321025	Thermocouple assembly for sparge mount	—	each	
321035	Sample needle for frit sparging	—	each	
321037	Tube assembly for carrier in to six-port valve 4	—	each	
321046	Tube assembly, six-port 5 to trap bulkhead fitting	—	each	
321047	Tube assembly for Eclipse six-port valve 1 to cross 4	—	each	
321048	Tube assembly for six-port valve 2 to water management fitting	—	each	
321079	Sample valve mounting bracket	—	each	
321080	Frosted frit sparger, swage inlet	5 mL, 18-mm neck O.D.	each	*

PN	Product	Size	Unit	XPN
321081	Frosted frit sparger, swage inlet	25 mL; 18-mm neck O.D.	each	*
321083	Sparge mount cover assembly	—	each	
321090	Eclipse pneumatics module, 115 V	—	each	
321091	Eclipse electronics module w/ touchscreen, 115 V	—	each	
321092	Fitting nut	—	each	
321097	Sparge cover assembly	—	each	
321100	Four-way injection valve, KEL-F	—	each	
321101	Tube assembly, cross 1 to valve A	—	each	
321125	Block for Foam Buster Option	—	each	
321134	Door interlock magnetic cable	—	each	
321145	Heated transfer line, blank, 115 V	48"	each	
321146	Heated transfer line, blank, 115 V	60"	each	
321147	Heated transfer line, blank, 230 V	48"	each	
321148	Heated transfer line, blank, 230 V	60"	each	
321149	Heater assembly for valve oven, 230 V	—	each	
321150	Heater assembly for sparge mount, 230 V	—	each	
321162	pH fill/drain manifold assembly	—	each	
321163	pH select manifold assembly	—	each	
321169	Cable clamp, p-clip, for transfer line strain relief	0.562	each	
321170	Bushing, snap	E/i" hole x 0.188" I.D.	each	
321171	Standoff, brass, female/female	4-40 x 1.00	each	
321174	Valve manifold assembly	—	each	
321175	DC actuator assembly	—	each	
321451	Infra-Sparge™ lamp for Eclipse, 120 V, 300 W	—	each	

PN	Product	Size	Unit	XPN
321452	Infra-Sparge™ lamp for Eclipse, 230 V, 250 W	—	each	
321954	Water management heater assembly, 240 V	—	each	
321469	Fitting, stainless steel for Foam Buster heater	¼-28 x 8x 0.7	each	*
321475	Sample needle for frit sparging with Foam Buster Option	—	each	
321476	Tube assembly for external drain	—	each	
321478	Frit sparger, swage inlet	5 mL, 18- mm neck O.D.	each	*
321479	Frit sparger, swage inlet	25 mL, 18- mm neck O.D.	each	*
321484	Heater and thermocouple assembly for Foam Buster Option (not voltage specific)	—	each	
321488	SOS™ assembly	—	each	
321578	Six-port valve, stainless steel	Q/qy"	each	
321579	Spring clip for drain tube	—	each	
321580	Compression spring, stainless steel	0.240 x 0.75	each	
321585	Touchscreen stylus	—	each	*
321586	Valve oven cover assembly	—	each	
321589	SOS™ shield	—	each	
321596	Water management fitting	—	each	*
321599	SOS™ adjustment screwdriver	—	each	
321602	Check valve, brass/nickel, 0.5 psi	10-32	each	
321603	Eclipse startup kit	—	each	
321604	Eclipse operator's manual and software	—	each	
321615	Needle sparge hardware kit	—	each	
321618	Eclipse electronics module w/ touchscreen, 230 V	—	each	

PN	Product	Size	Unit	XPN
321619	Eclipse pneumatics module, 230 V	—	each	
321651	Sample needle for needle sparging	—	each	
321659S	Sample filter assembly	Q/qy–Q/i"	each	*
321672	Fuse, 5 A, fast-blo	5 x 20 mm	each	*
321678	Ferrule, Tefzel, flangeless	3 mm	each	*
321681	Air pump assembly	—	each	
321685	Probe - pH Detect	—	each	
321691	Tube assembly, TFE, drain line	—	each	
321692	Tube assembly, transfer line	4 feet	each	
321693	Tube assembly, transfer line	5 feet	each	
321696	Frosted needle sparger	5 mL	each	*
321697	Frosted needle sparger	25 mL	each	*
321700	Sample needle for needle sparging with Foam Buster Option	—	each	
321728	Interface kit, Eclipse to Model 4552	—	each	
321736	Lamp cover assembly w/ filter	—	each	
321747	Eclipse electronics module w/o touchscreen, 115 V	—	each	
321748	Eclipse electronics module w/o touchscreen, 230 V	—	each	
321749	Fuse, 1.6 A, fast-blo	5 x 20 mm	each	*
321901	Ethernet twisted pair cable (Eclipse to PC)	—	each	
321902	Ethernet cable (Eclipse to network)	—	each	
321906	O-ring with mesh for valve PN 320594	—	each	
321932	Tube assembly, sparge mount to filter	Q/qy–Q/i"	each	*
322237	Fitting nut for Foam Buster Option, PEEK	Q/qy x ¼-28	each	*

PN	Product	Size	Unit	XPN
322247	Fitting and ferrule, flangeless, PEEK and ETFE	Q/qy" x ¼-28 fitting, Q/qy" ferrule	5/pk	*
322248	Ferrule, ETFE	Q/qy"	5/pk	*
322249	Fitting and ferrule for Foam Buster needle	Q/qy" x ¼-28	set	*
323584	Tubing - Silicone	¼" x Q/i"	foot	*
324084	Fitting - CPVC, reverse	¼-28	each	*
324106	Reservoir - pH glass	—	each	
324113	Cap manifold	—	each	
324115	Thumbscrew - Stainless Steel	10-32 x 0.375	each	*
324124	Ferrule, TFE	½"	each	*
327222-T	I/O board	—	each	
328099	Kit-Replace Display/Touch Screen	—	each	
327544	Valve - 3-way, 12 V isolation	—	each	
328361	SOM board	—	each	
217711NI	Plug fitting, nickel plated	—	each	*
A001493	Fitting - bulkhead PEEK	¼-28 x ¼-28	each	
A303-0709-00	Clip fitting for holding stylus to unit	—	each	*



Chapter 17 Assembly Diagrams

List of Assembly Diagrams

Figure 17.1: Electronics Module	page 253
Figure 17.2: Electronics Module	page 254
Figure 17.3: Electronics Module	page 255
Figure 17.4: Pneumatics module	page 256
Figure 17.5: Pneumatics module	page 257
Figure 17.6: Pneumatics module	page 258
Figure 17.7: Pneumatics module	page 259
Figure 17.8: Pneumatics module	page 260
Figure 17.9: Pneumatics module	page 261
Figure 17.10: Internal plumbing	page 262
Figure 17.11: Trap bulkhead assembly	page 263
Figure 17.12: Valve manifold assembly	page 264

Assembly Diagrams

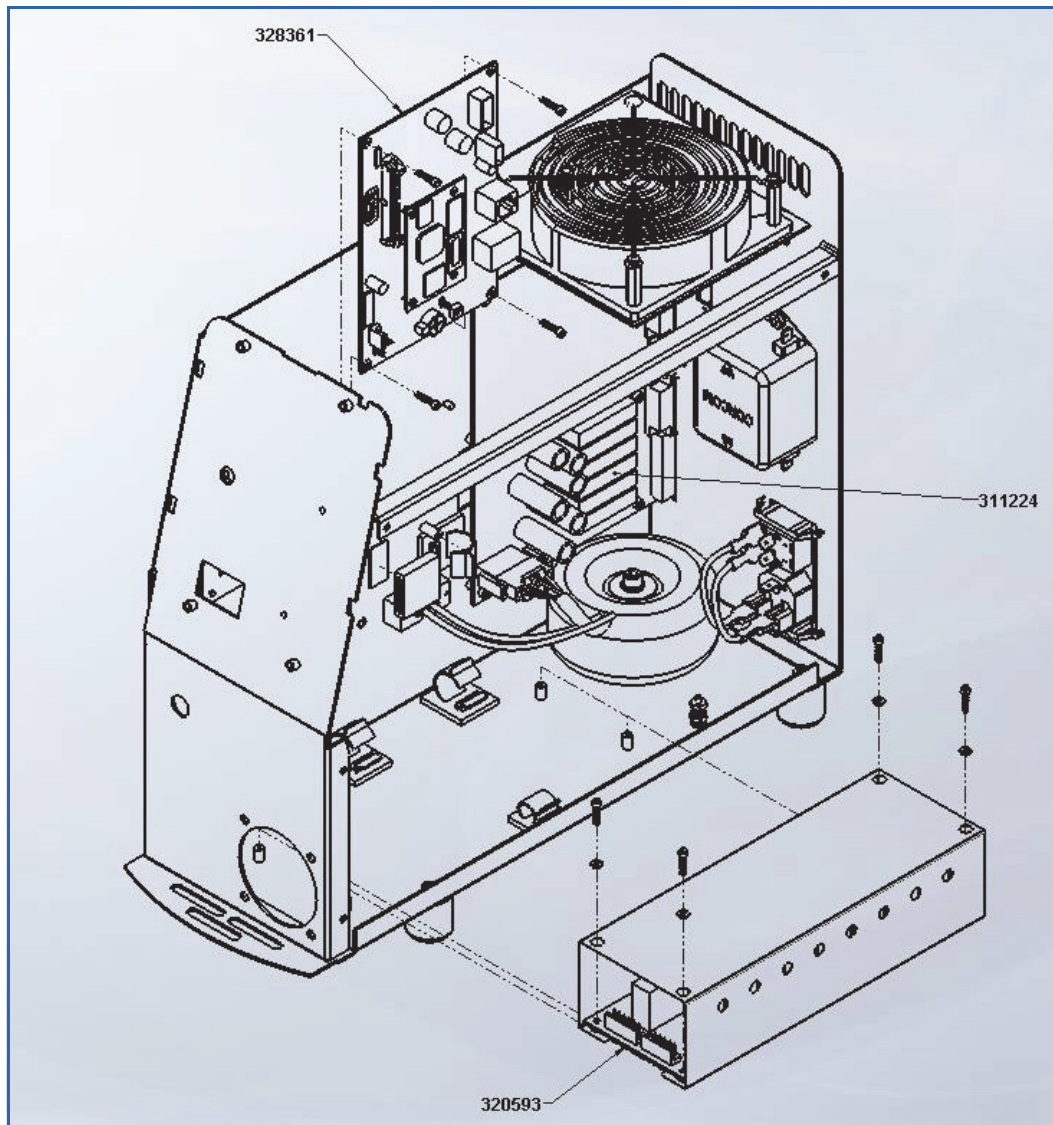

Figure 17.1. Electronics Module

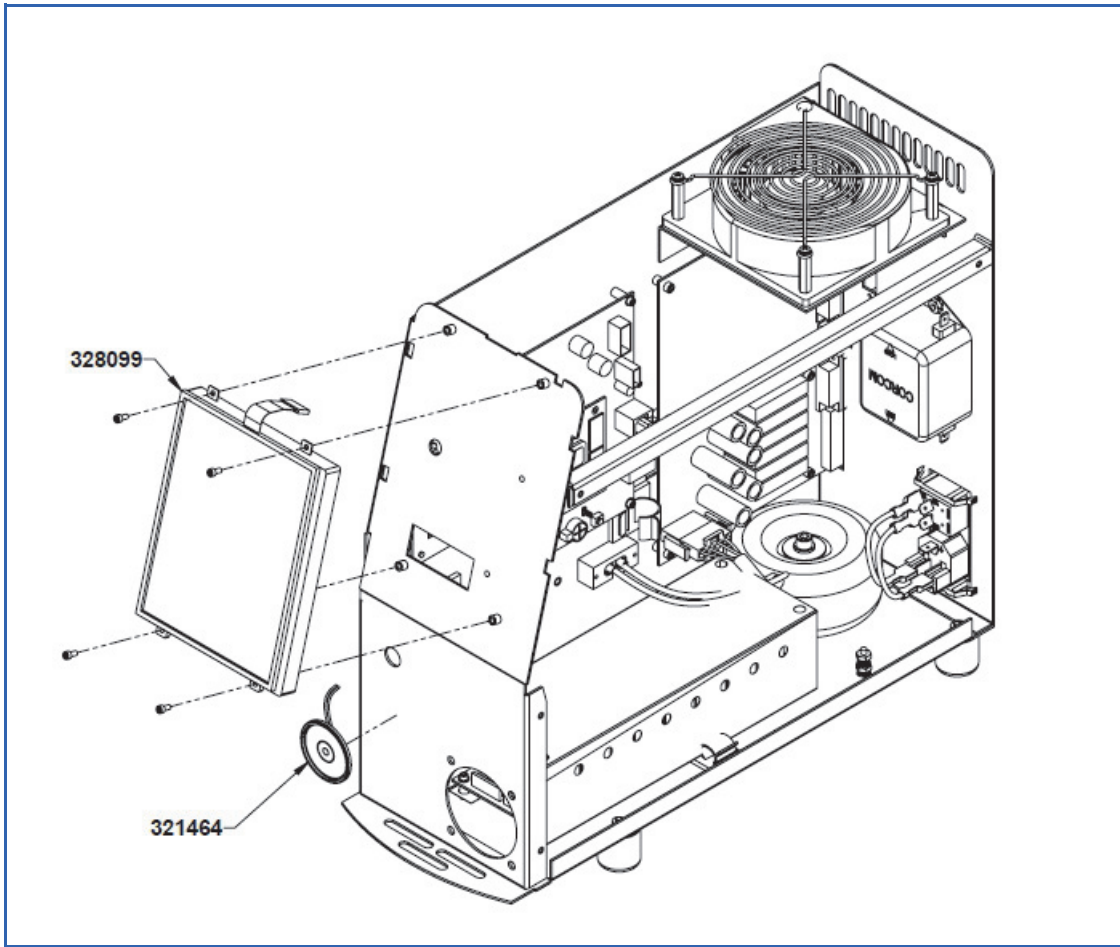

Figure 17.2. Electronics Module

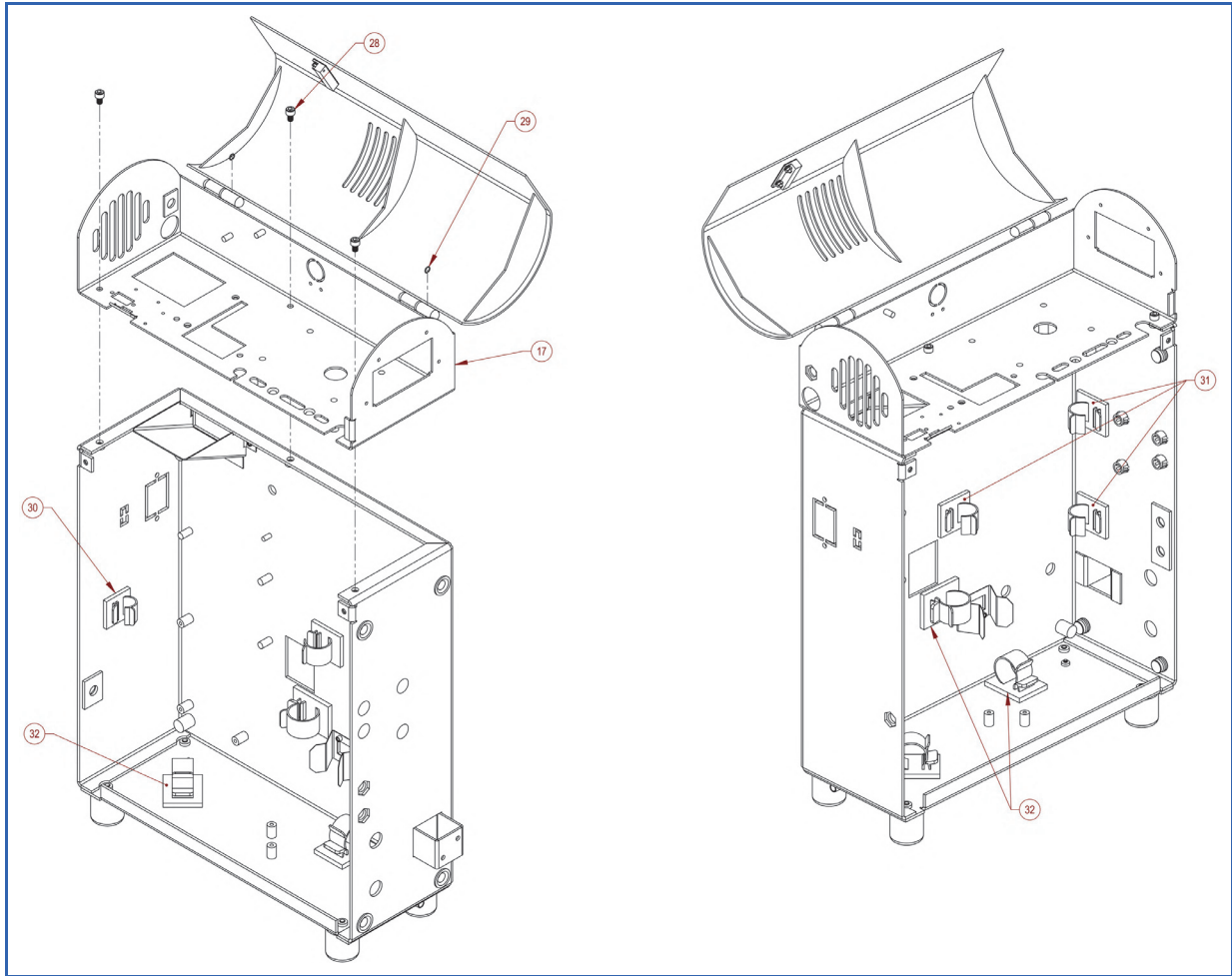

Figure 17.3. Electronics Module

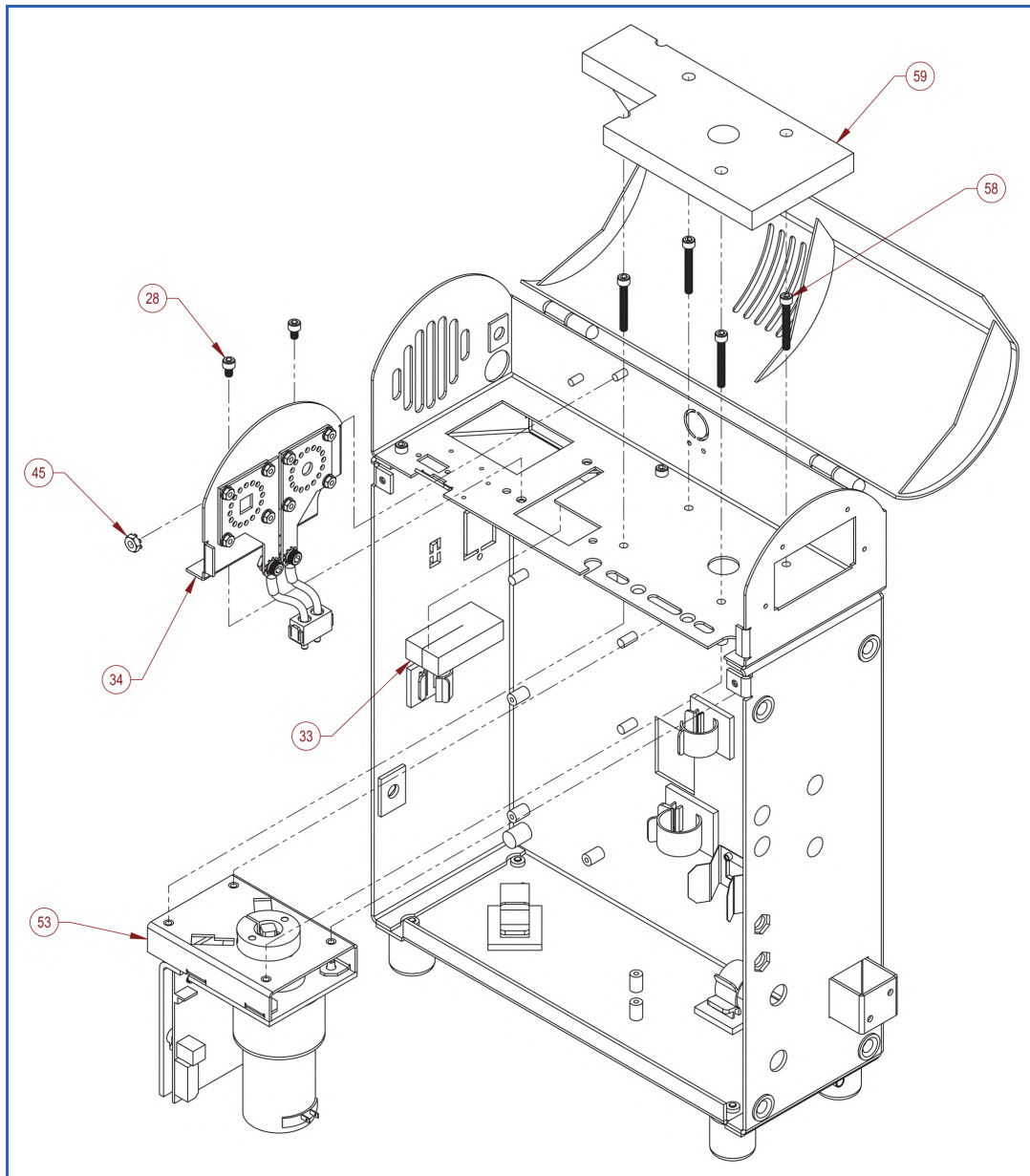

Figure 17.4. Pneumatics module

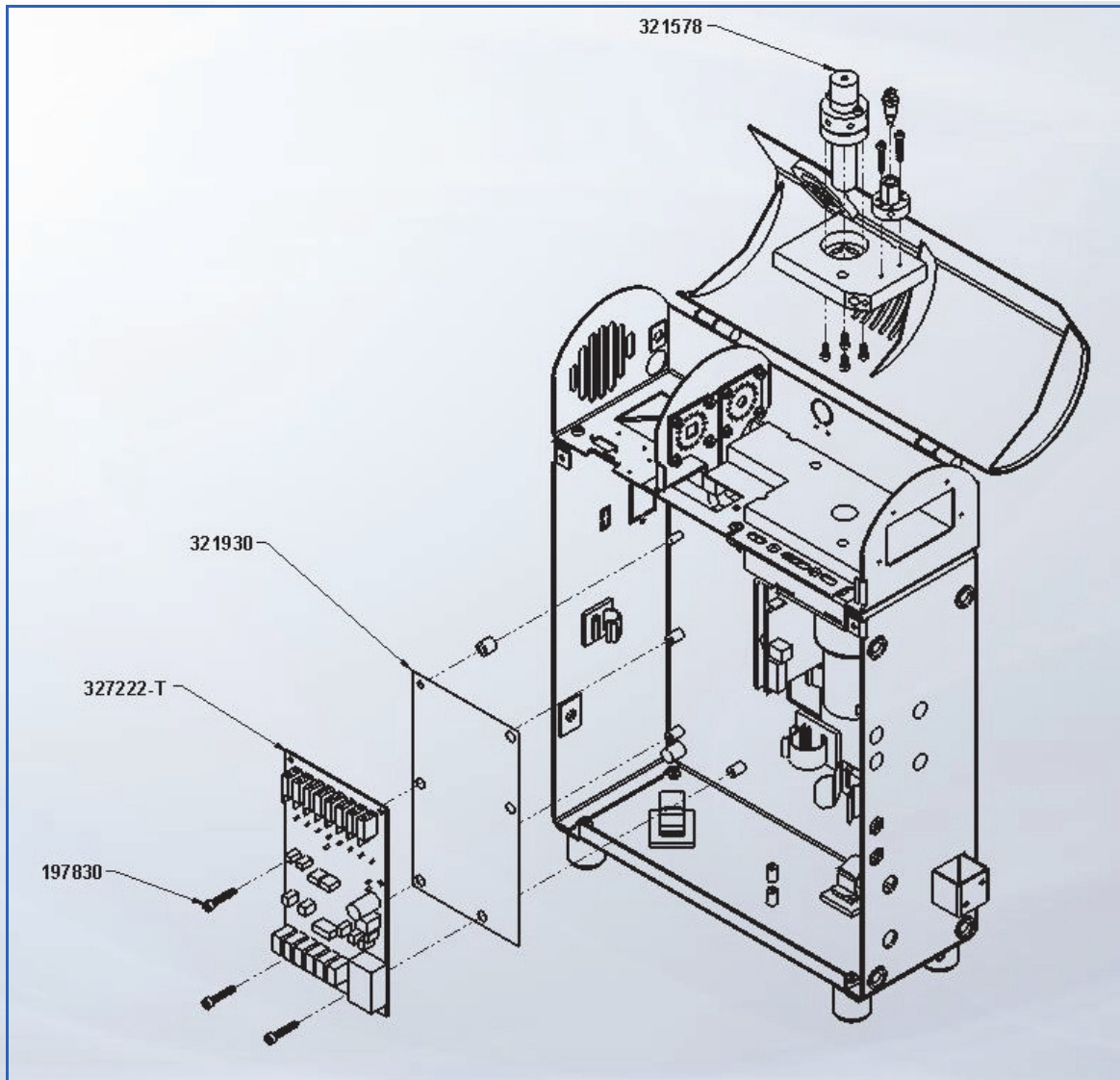

Figure 17.5. Pneumatics module

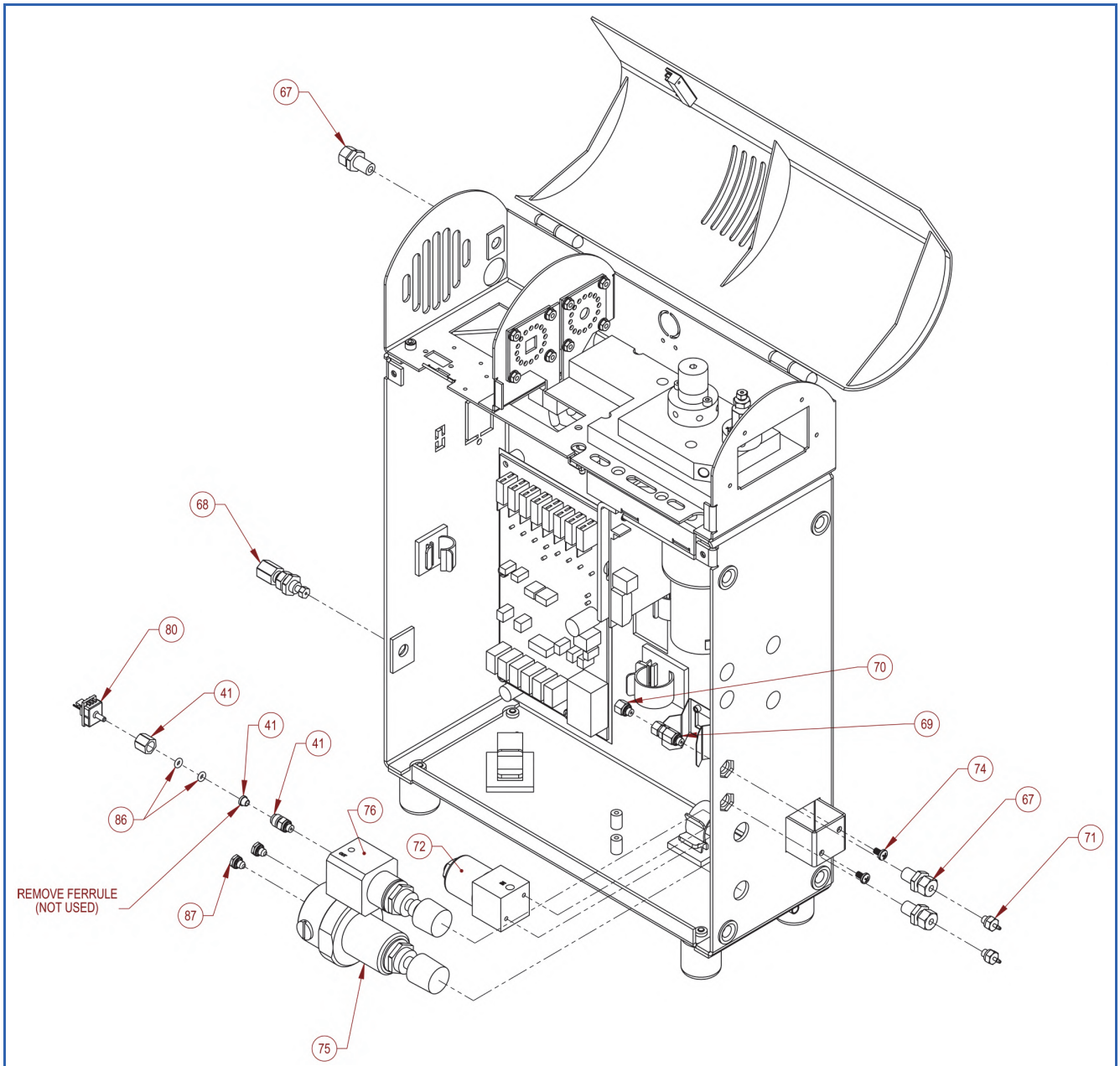

Figure 17.6. Pneumatics module

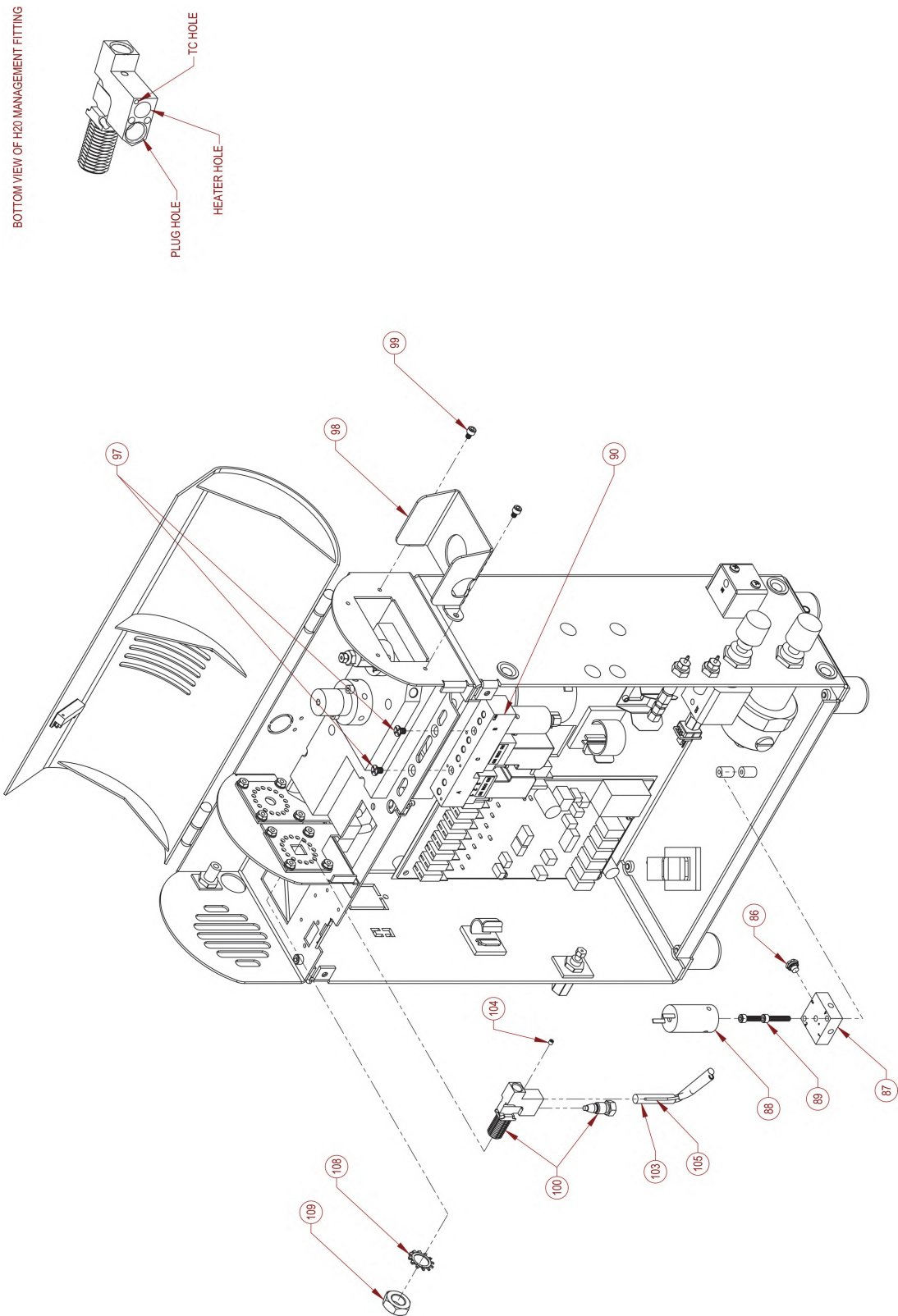

Figure 17.7. Pneumatics module

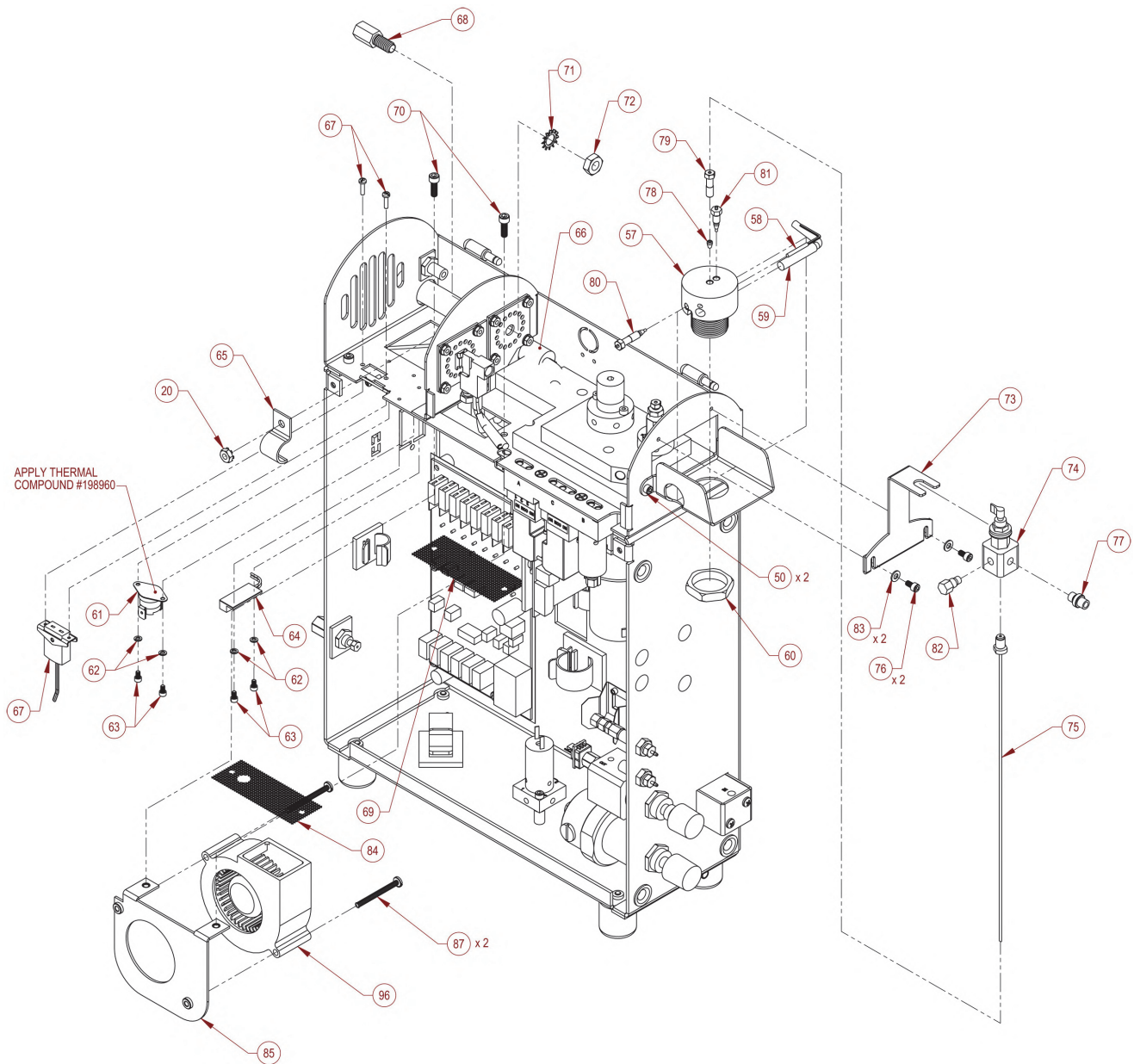

Figure 17.8. Pneumatics module

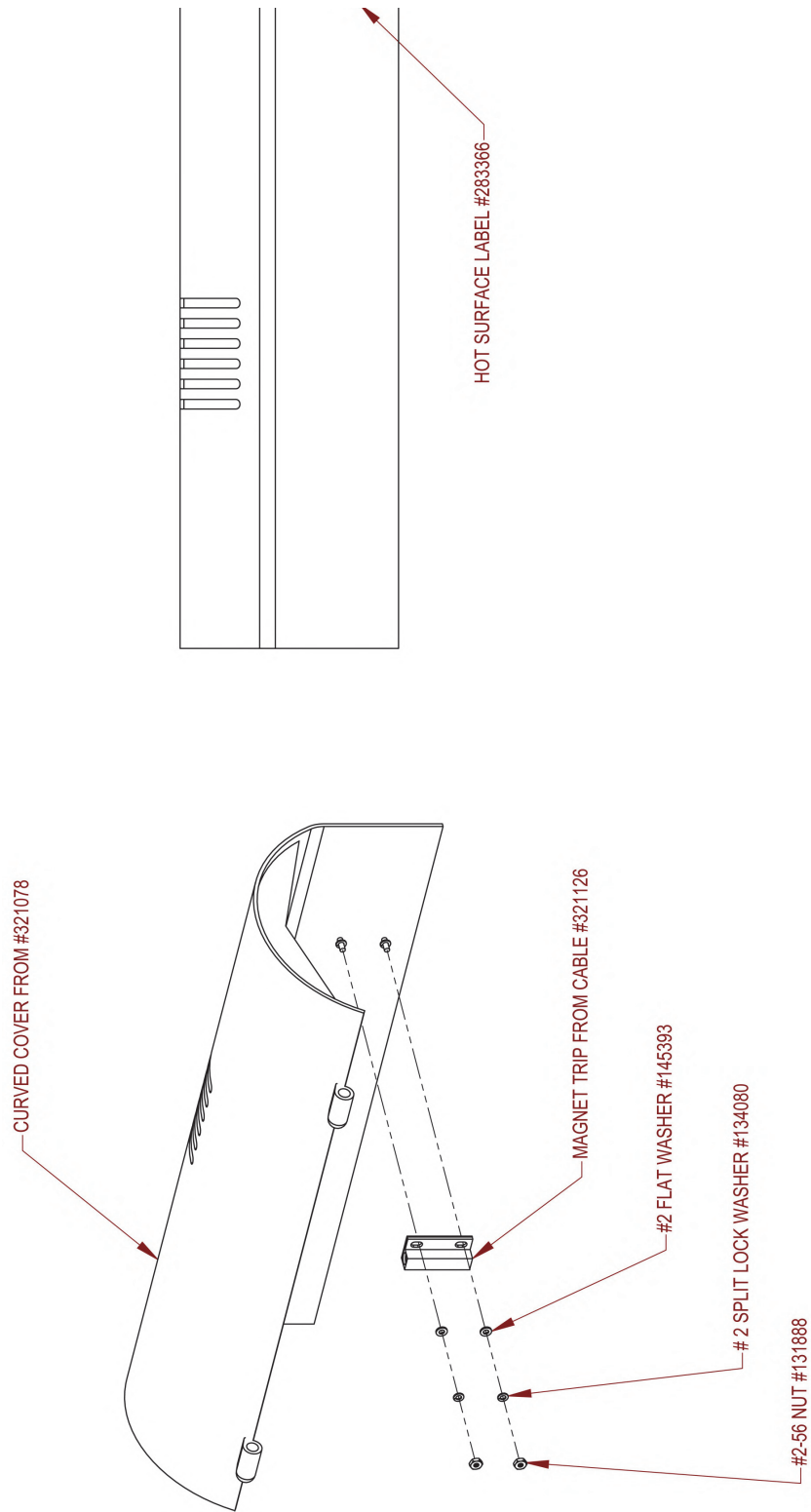

Figure 17.9. Pneumatics module

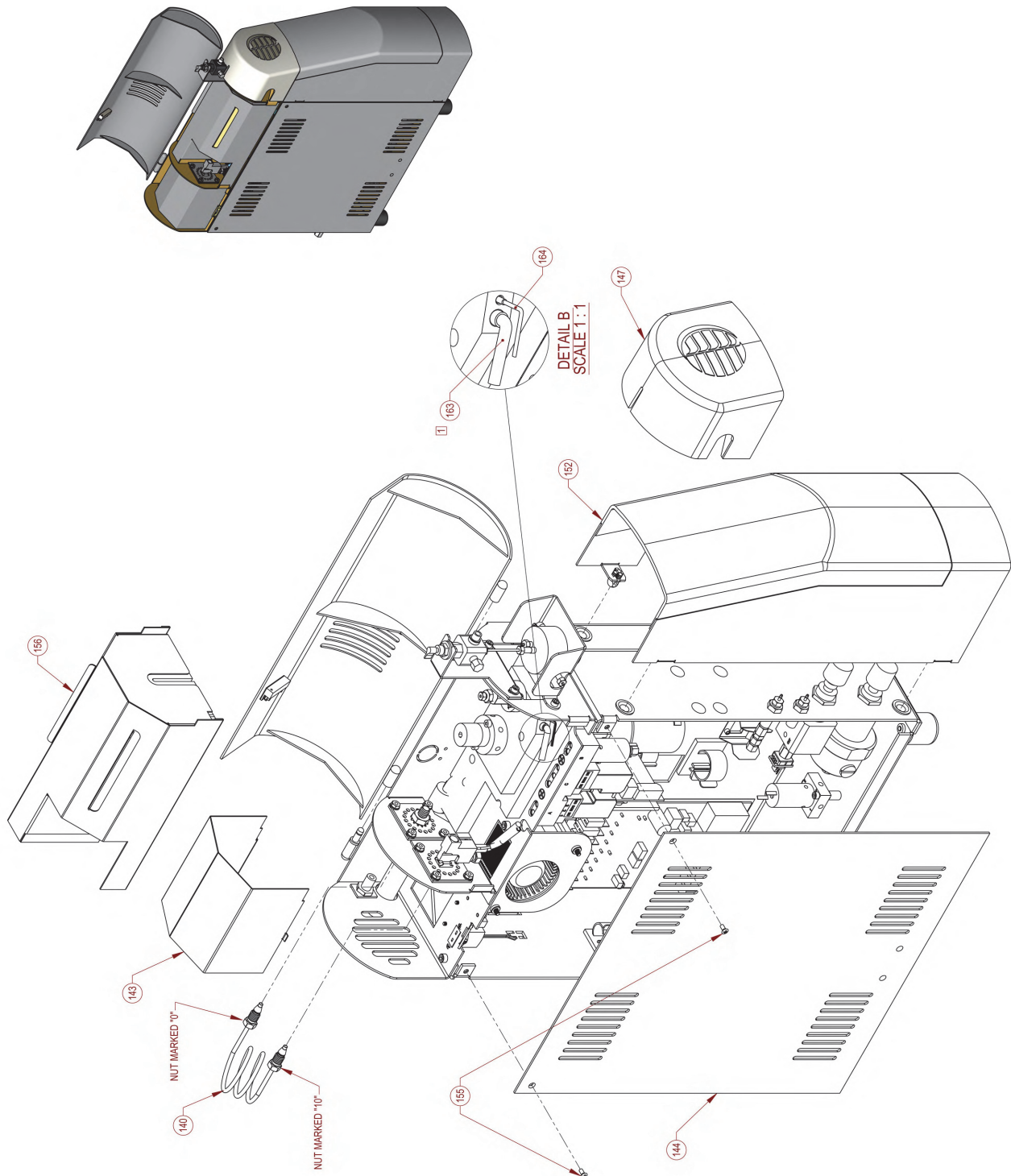

Figure 17.10. Internal plumbing

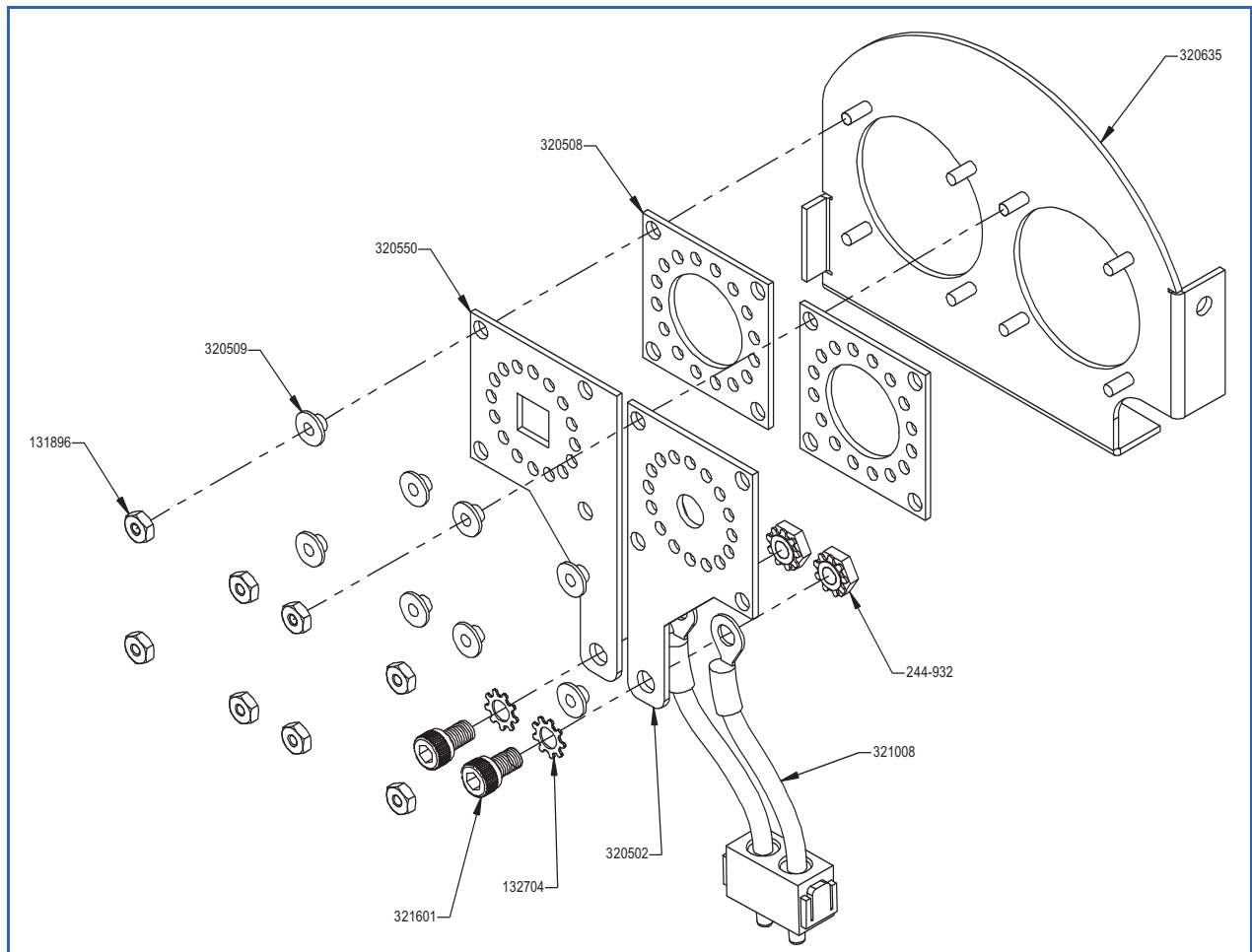

Figure 17.11. Trap bulkhead assembly

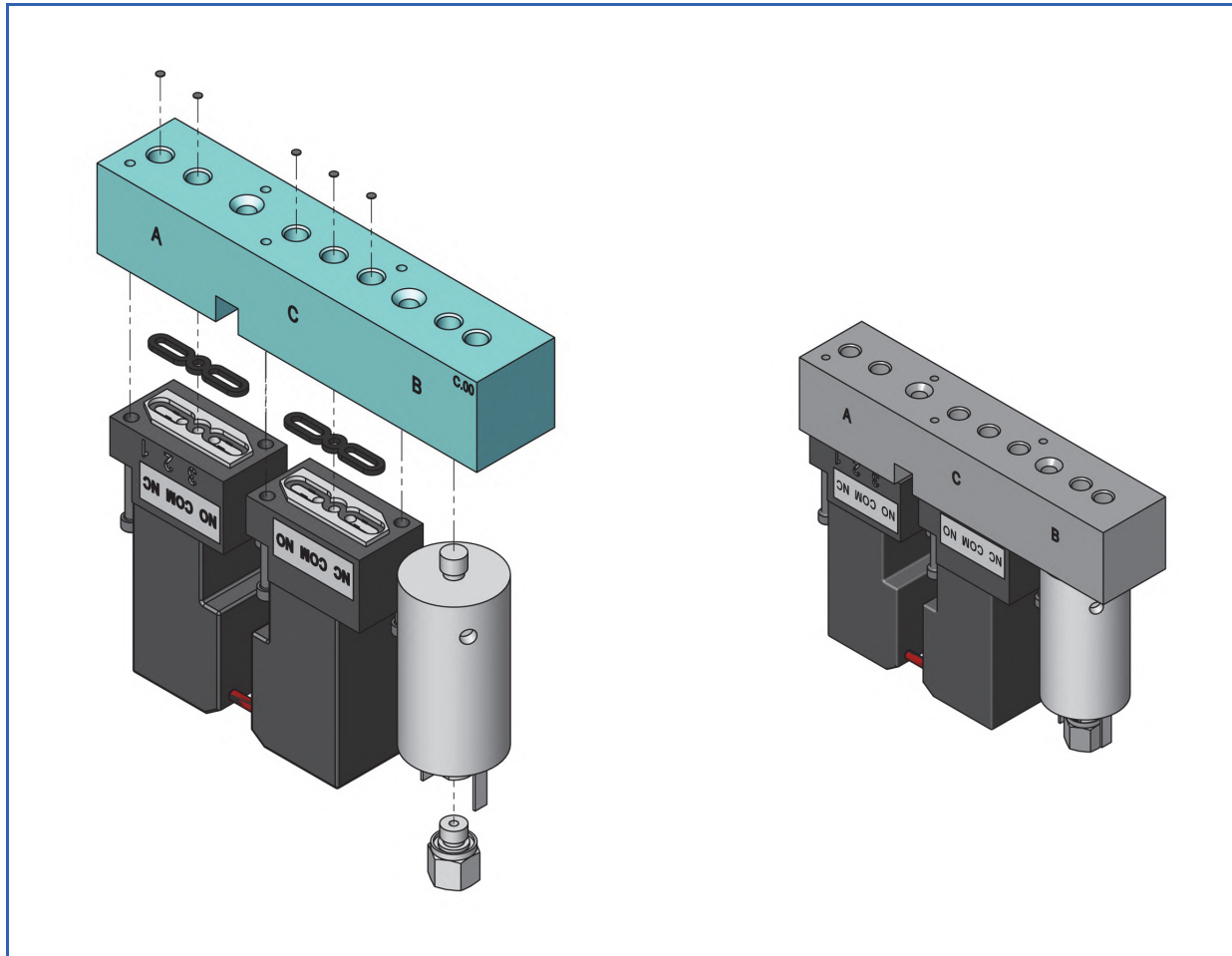

Figure 17.12. Valve manifold assembly



Chapter 18 Flow Diagrams

List of Flow Diagrams

Figure 18.1: Purge ready (flow enabled)	page 266
Figure 18.2: Purge ready (flow disabled)	page 267
Figure 18.3: Prepurge	page 268
Figure 18.4: Sample preheat (no flow)	page 269
Figure 18.5: Purge	page 270
Figure 18.6: Dry purge	page 271
Figure 18.7: Purge complete.....	page 272
Figure 18.8: Desorb ready (no flow)	page 273
Figure 18.9: Desorb preheat (no flow)	page 274
Figure 18.10: Desorb with drain.....	page 275
Figure 18.11: Desorb without drain.....	page 276
Figure 18.12: Backflush bake with purge.....	page 277
Figure 18.13: Backflush bake without purge.....	page 278
Figure 18.14: Depressurize.....	page 279
Figure 18.15: Standby.....	page 280
Figure 18.16: Drain.....	page 281
Figure 18.17: Leak test A (dry system)	page 282
Figure 18.18: Leak test B (dry system)	page 283
Figure 18.19: Leak test A (wet system).....	page 284
Figure 18.20: Leak test B (wet system).....	page 285

Flow Diagrams

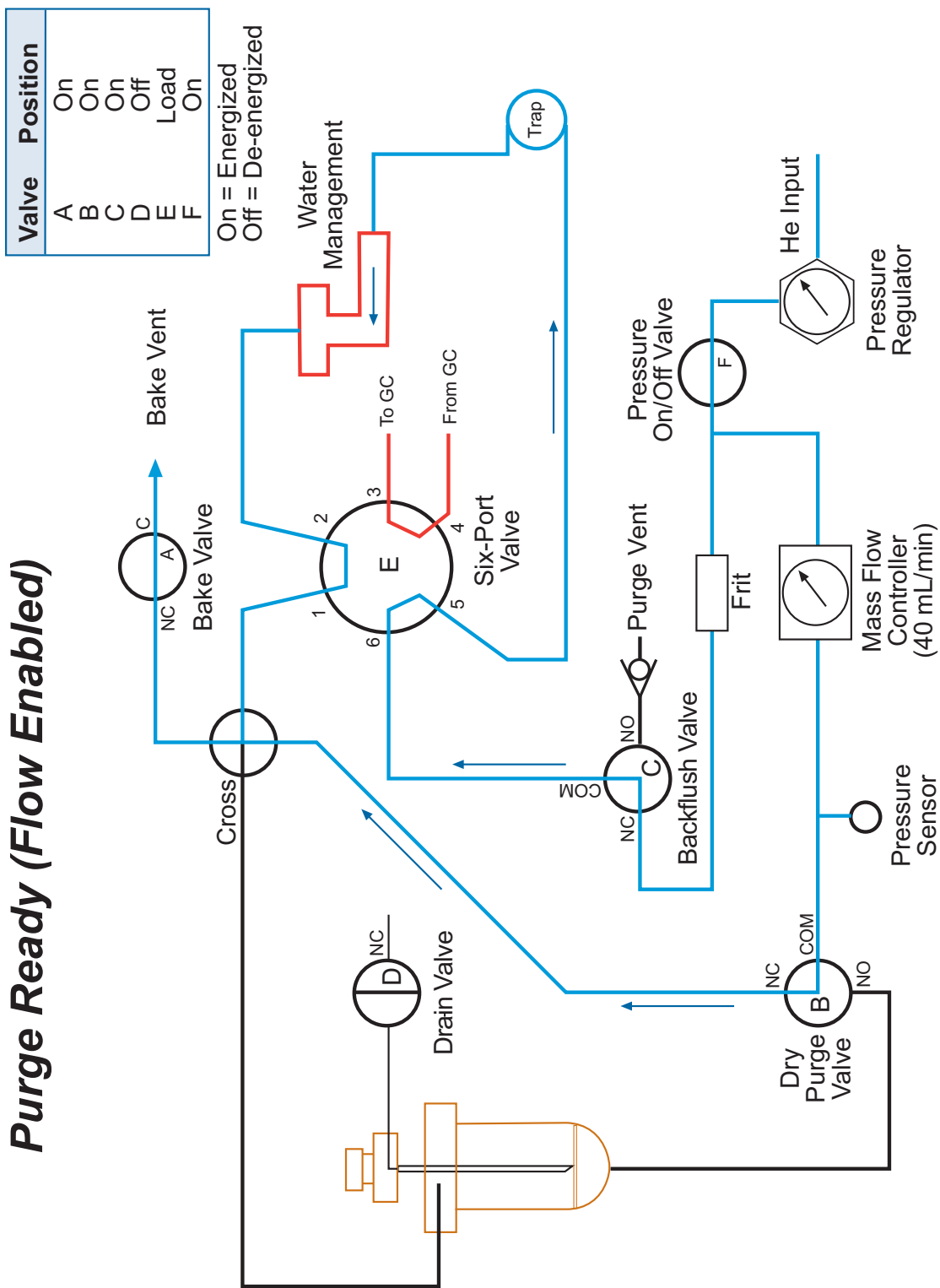

Figure 18.1. Purge ready (flow enabled)

Purge Ready (Flow Disabled)

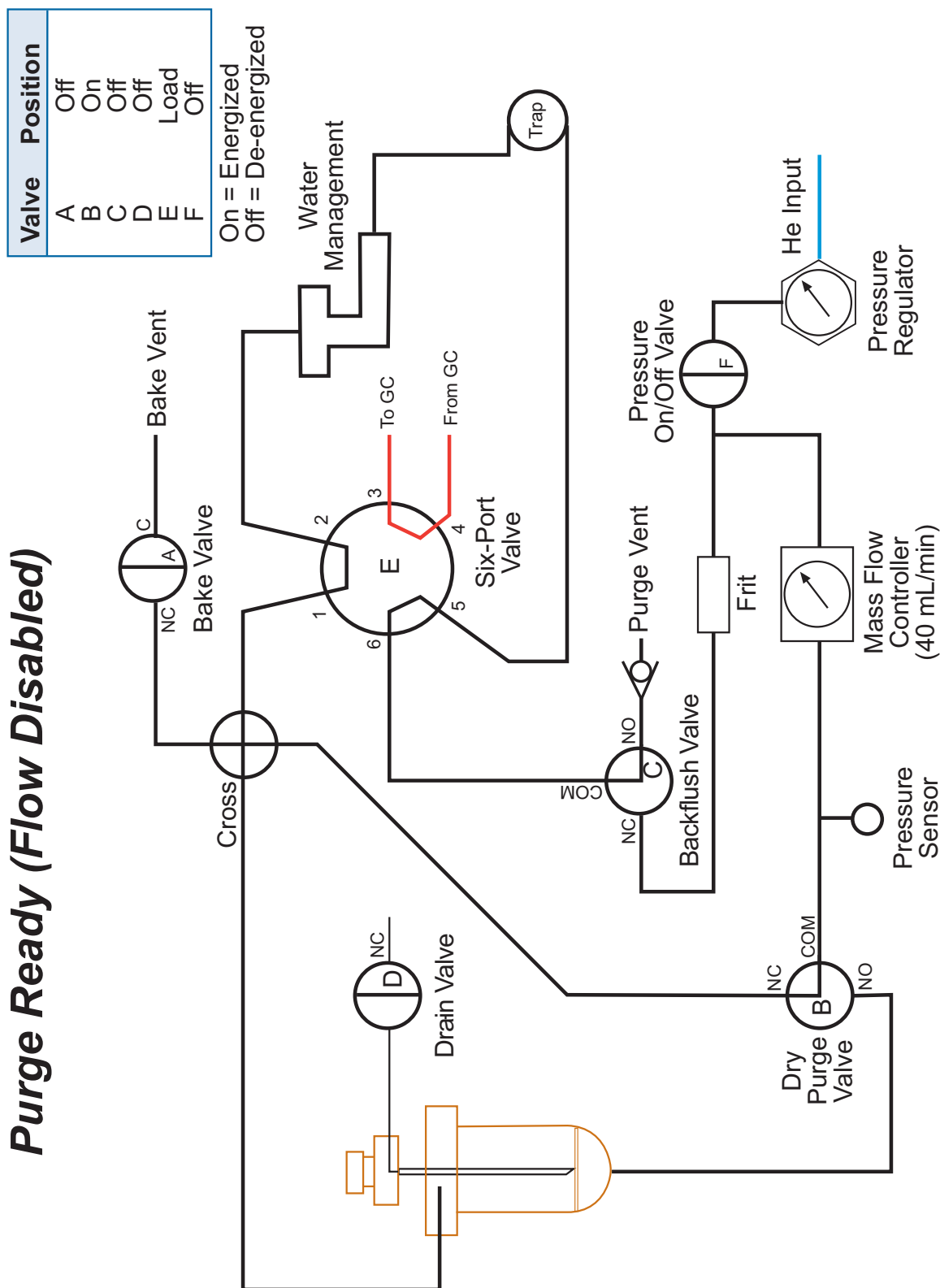

Figure 18.2. Purge ready (flow disabled)

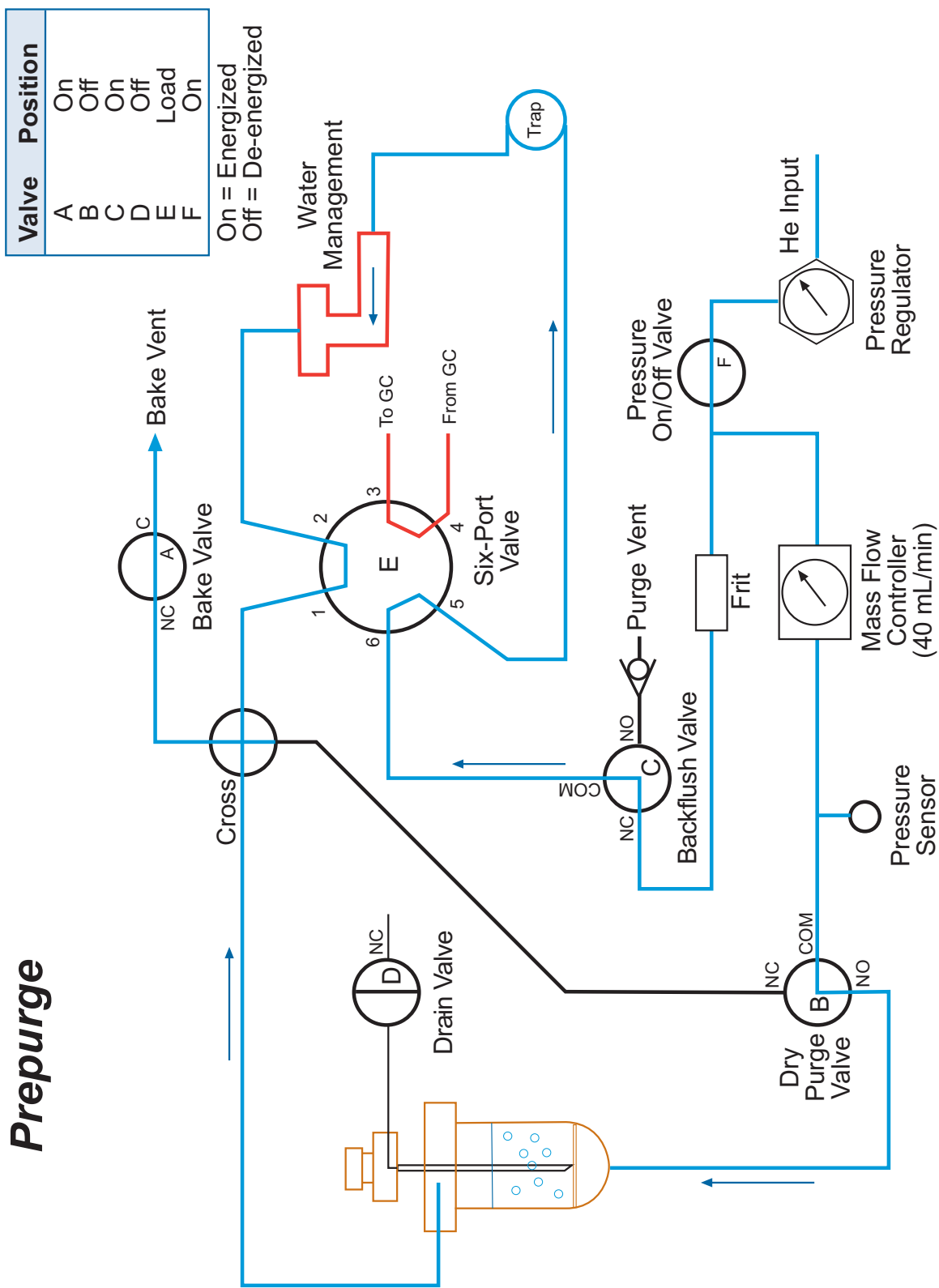

Figure 18.3. Prepurge

Sample Preheat (No Flow)

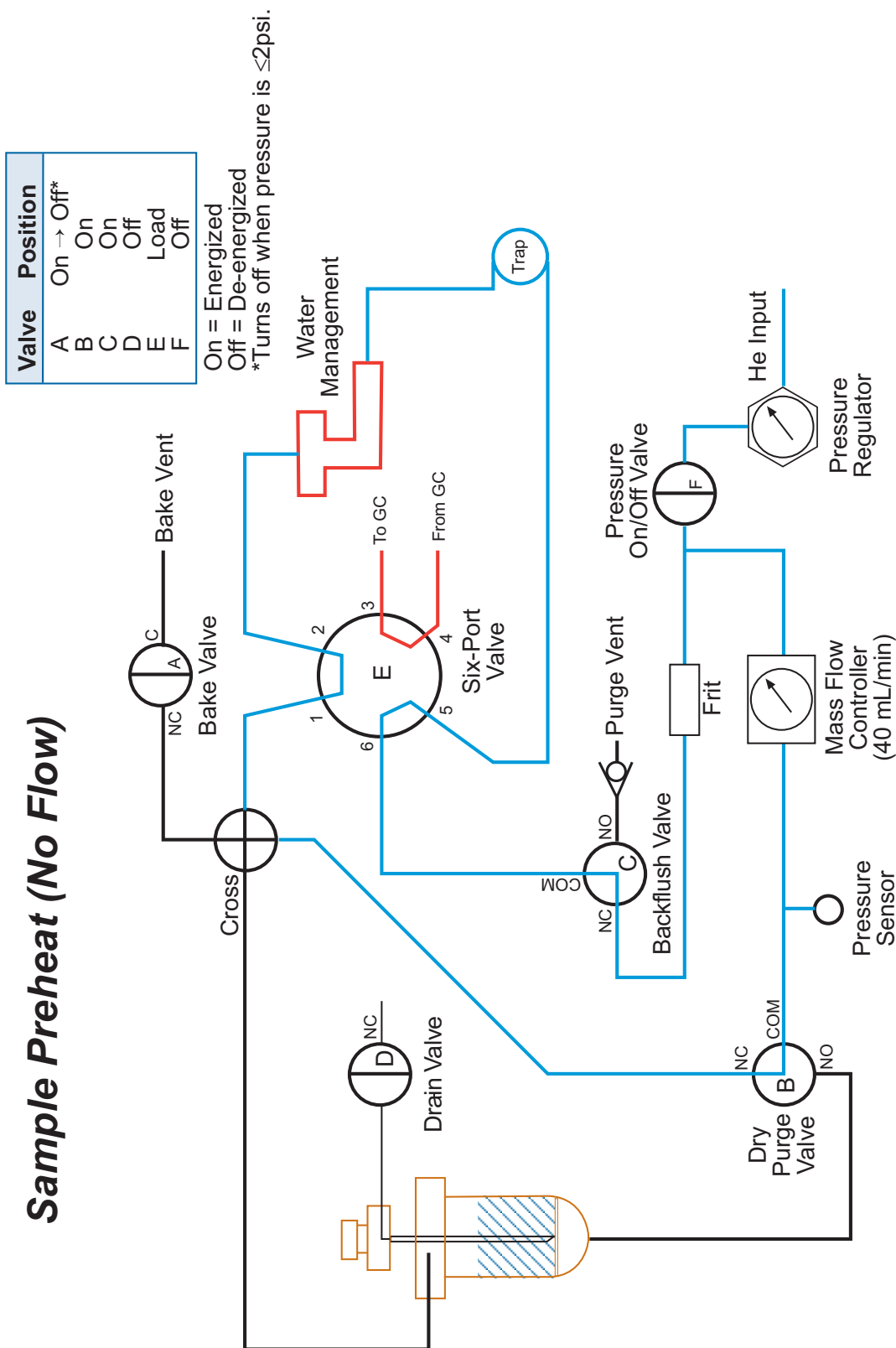

Figure 18.4. Sample preheat (no flow)

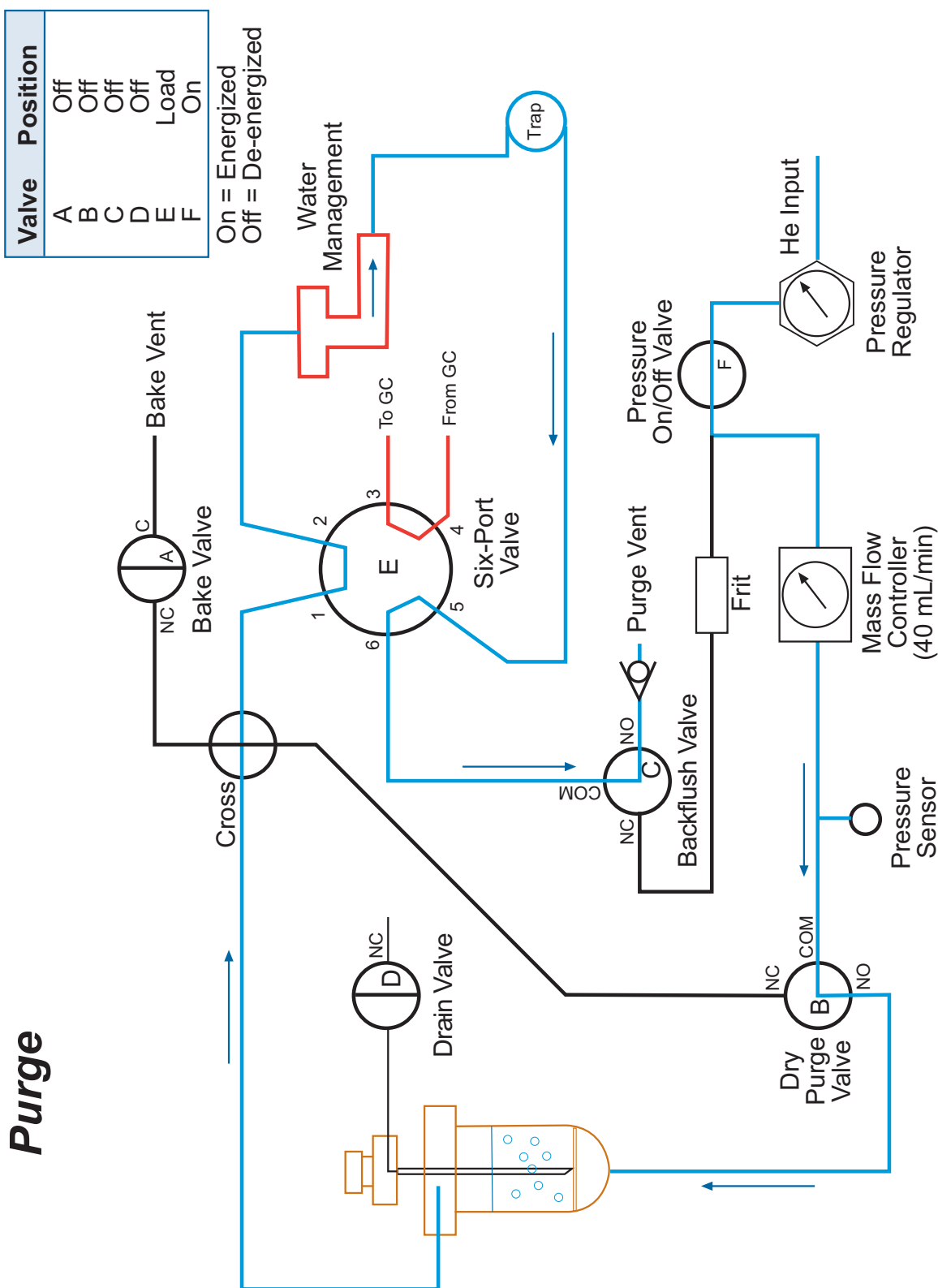

Figure 18.5. Purge

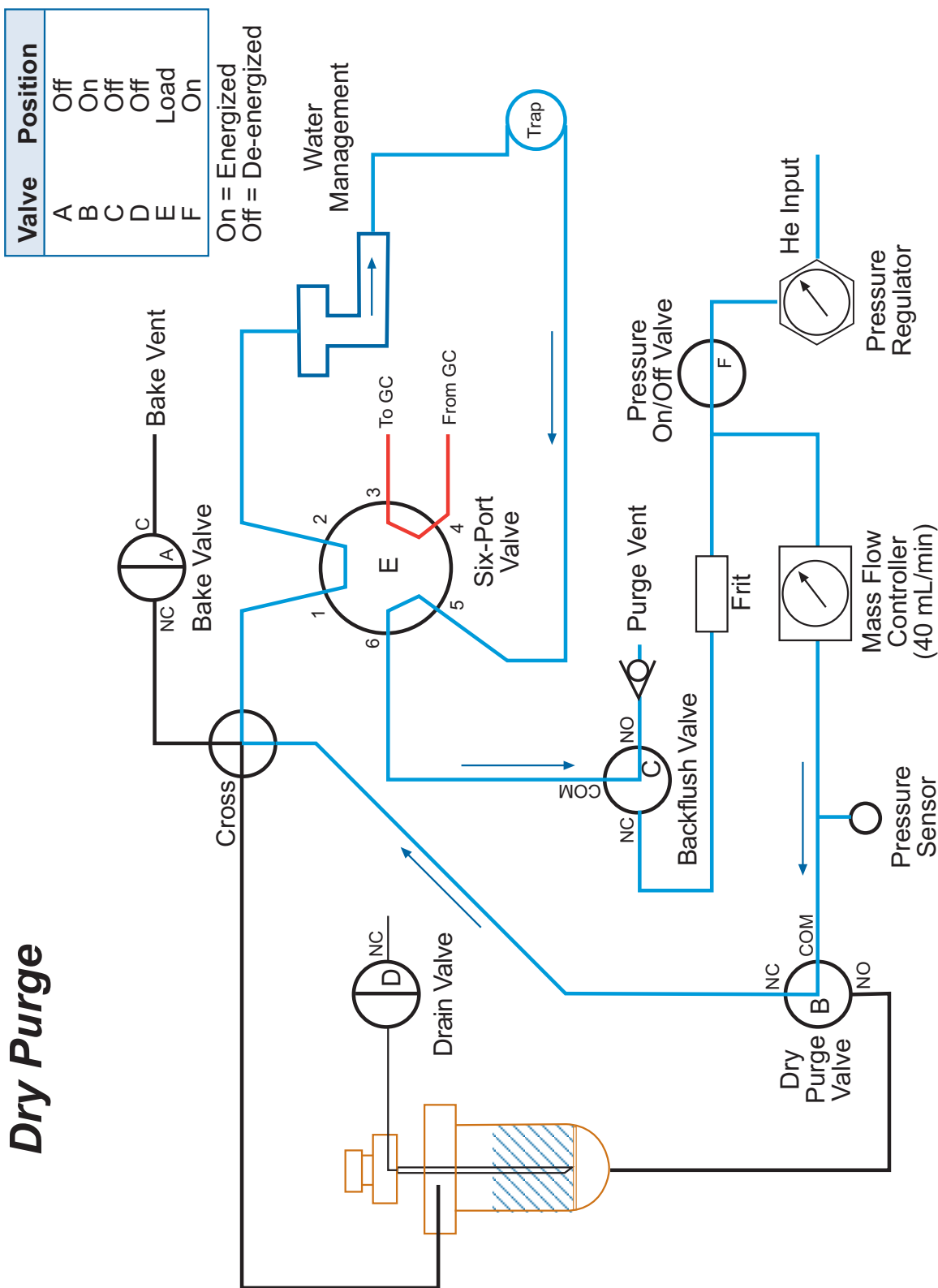

Figure 18.6. Dry purge

Purge Complete

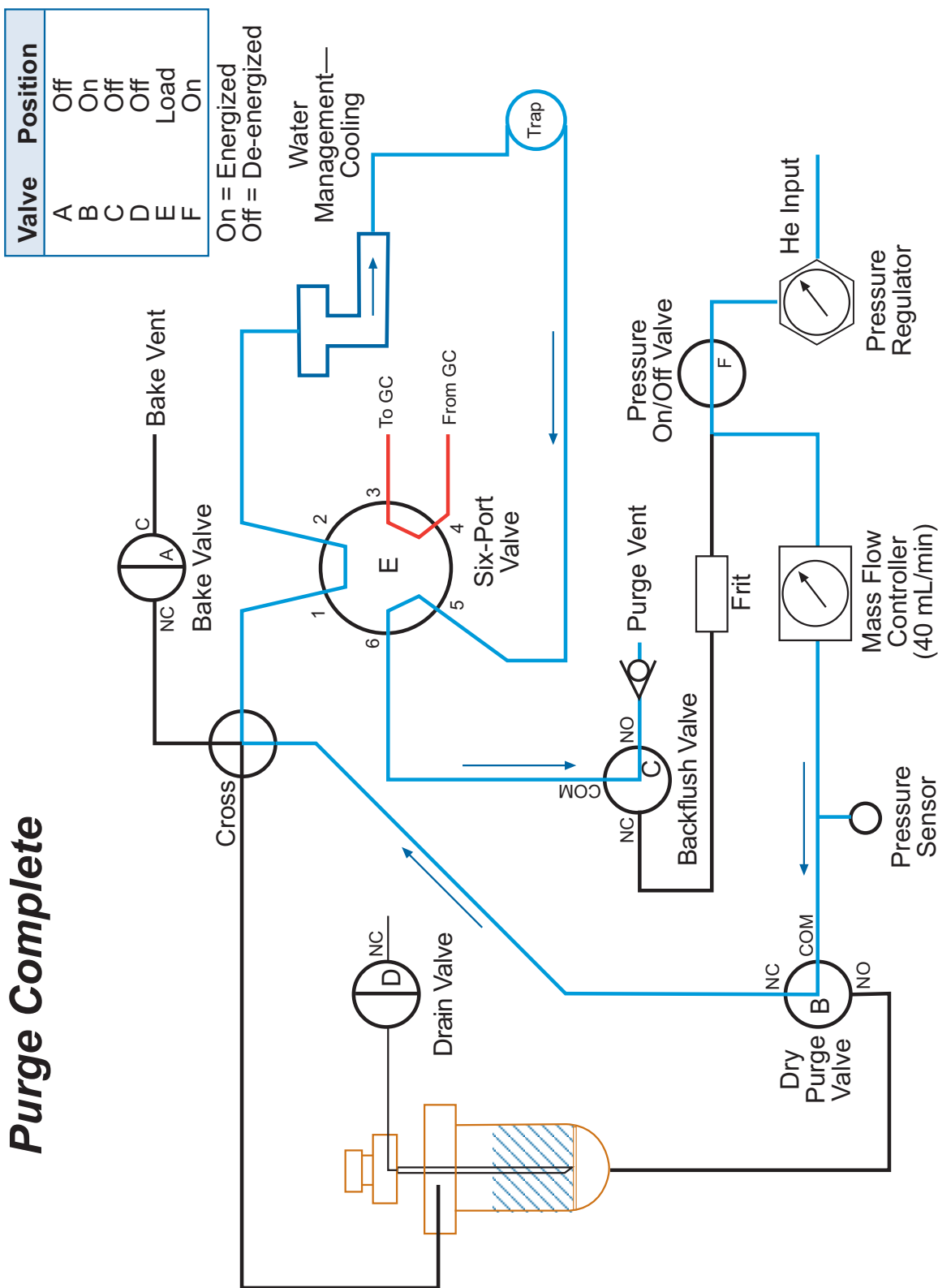

Figure 18.7. Purge complete

Desorb Ready (No Flow)

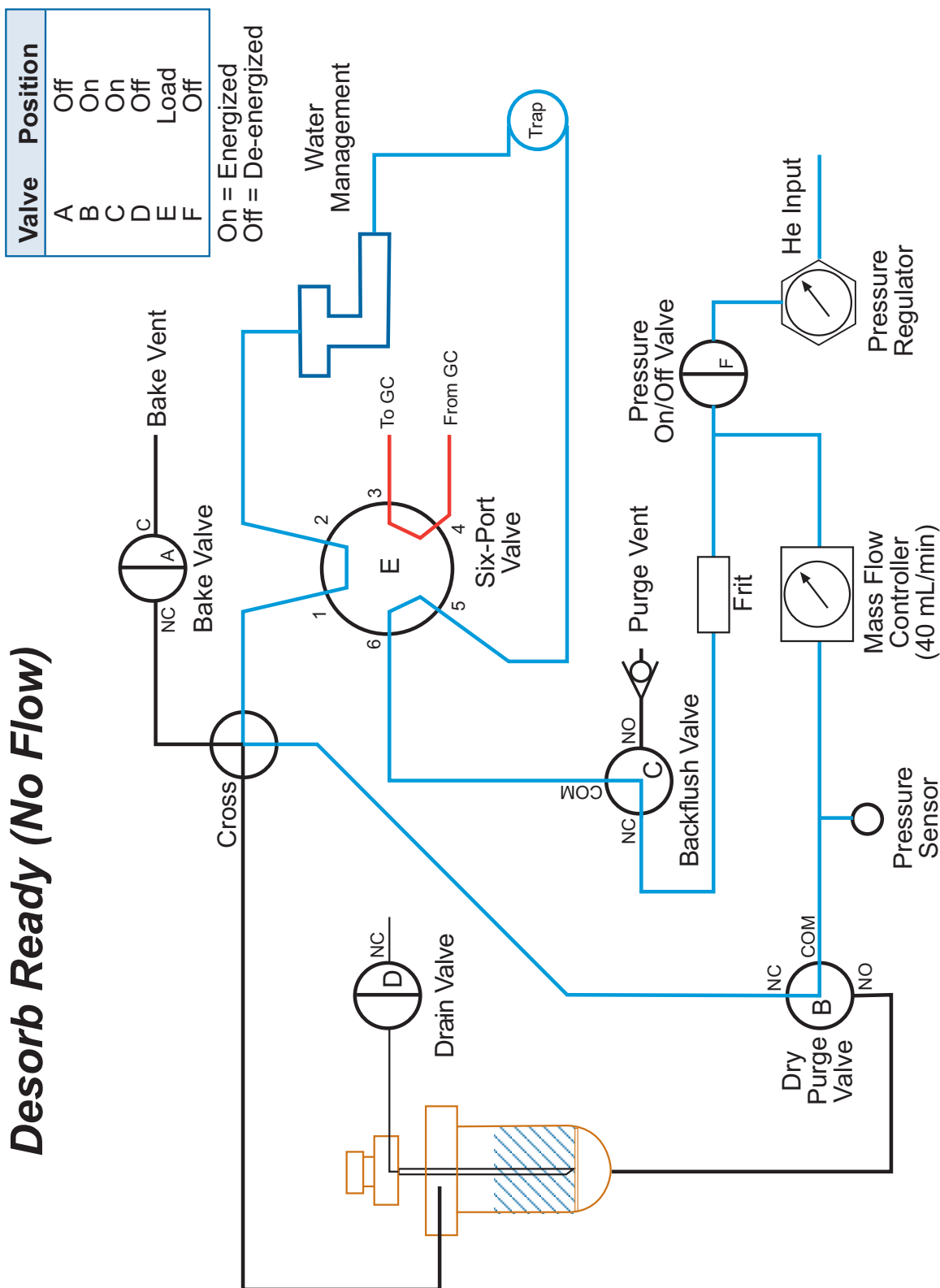

Figure 18.8. Desorb ready (no flow)

Desorb Preheat (No Flow)

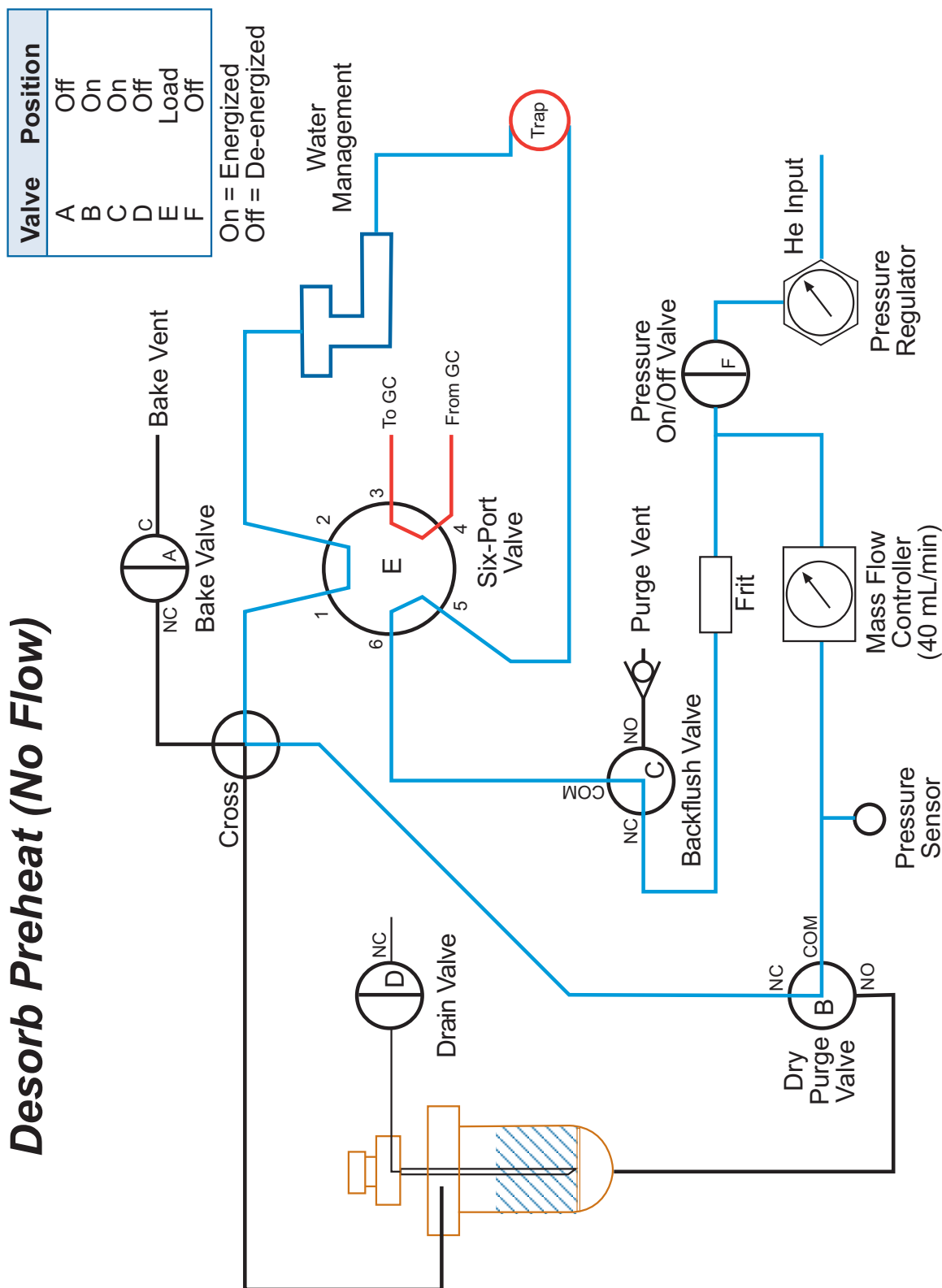

Figure 18.9. Desorb preheat (no flow)

Desorb with Drain

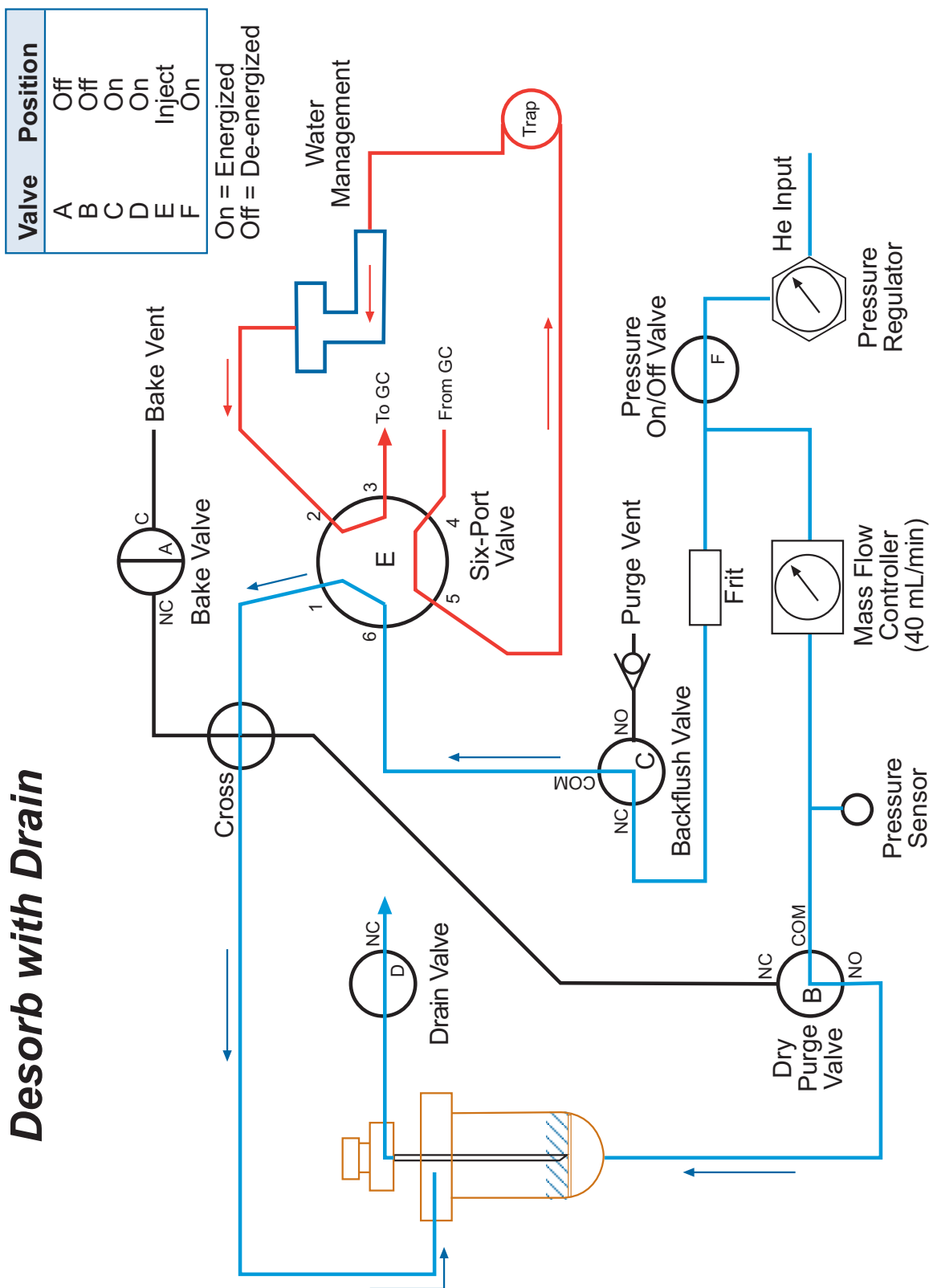

Figure 18.10. Desorb with drain

Desorb without Drain

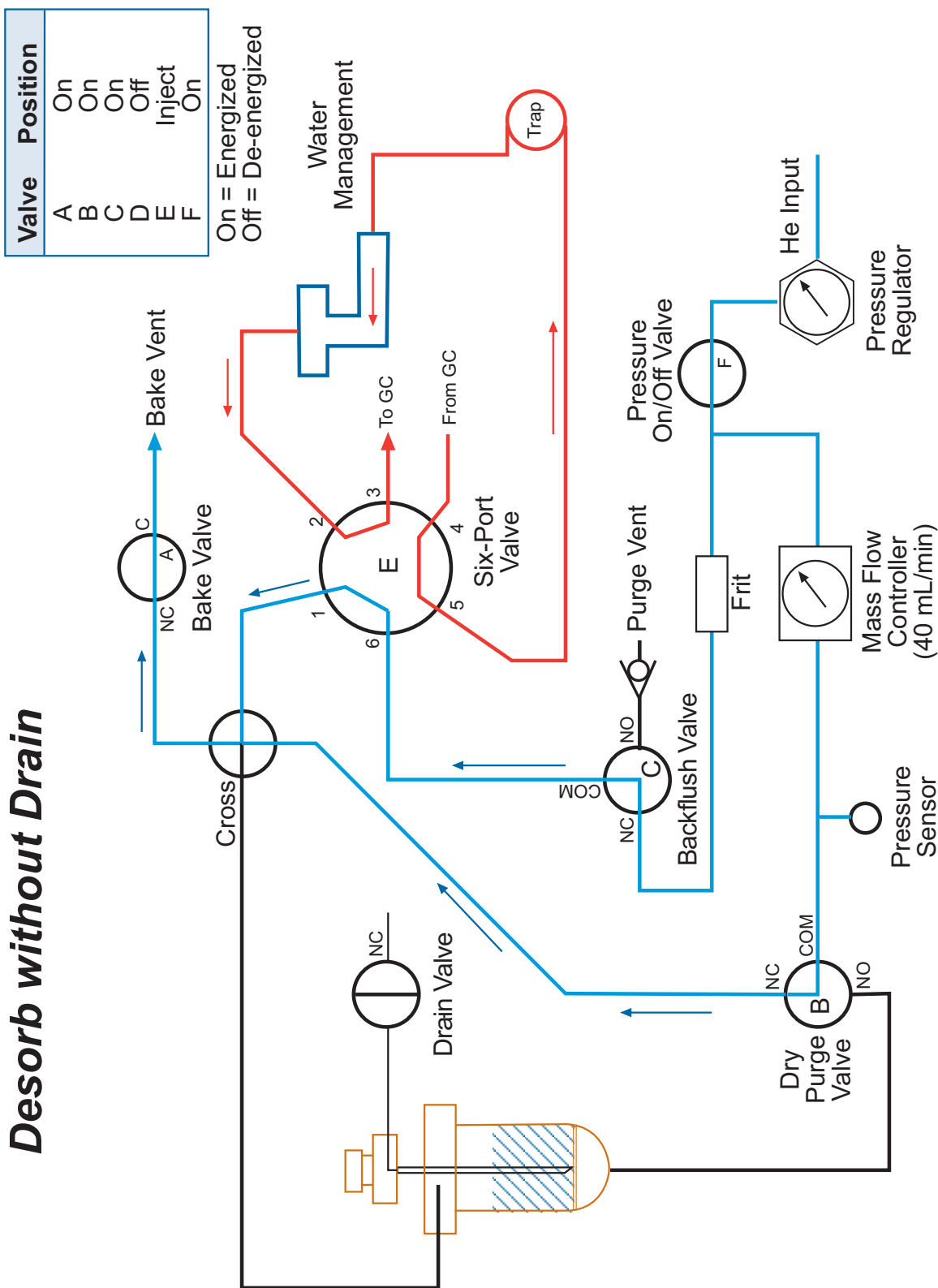

Figure 18.11. Desorb without drain

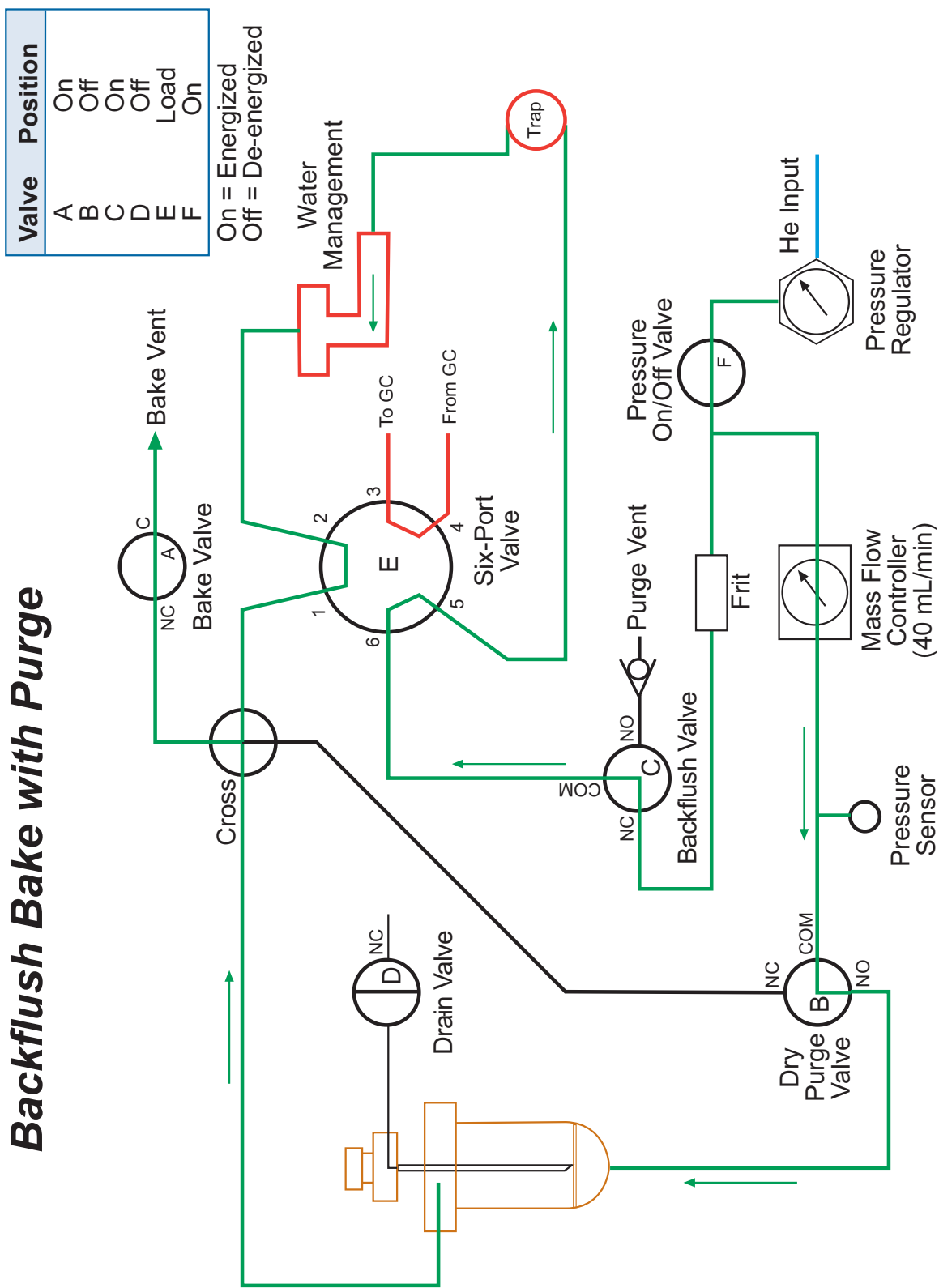

Figure 18.12. Backflush bake with purge

Backflush Bake without Purge

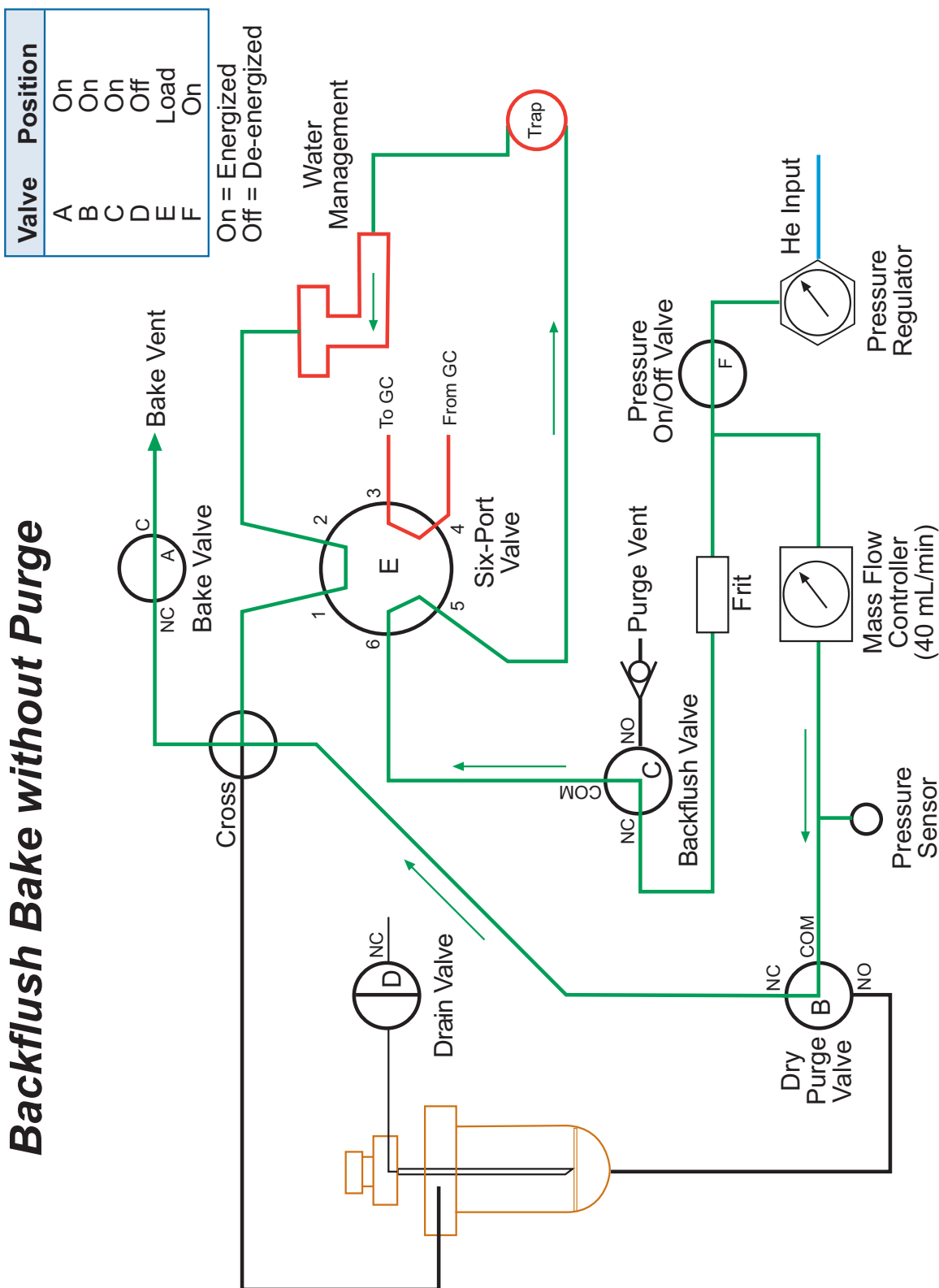

Figure 18.13. Backflush bake without purge

Depressurize

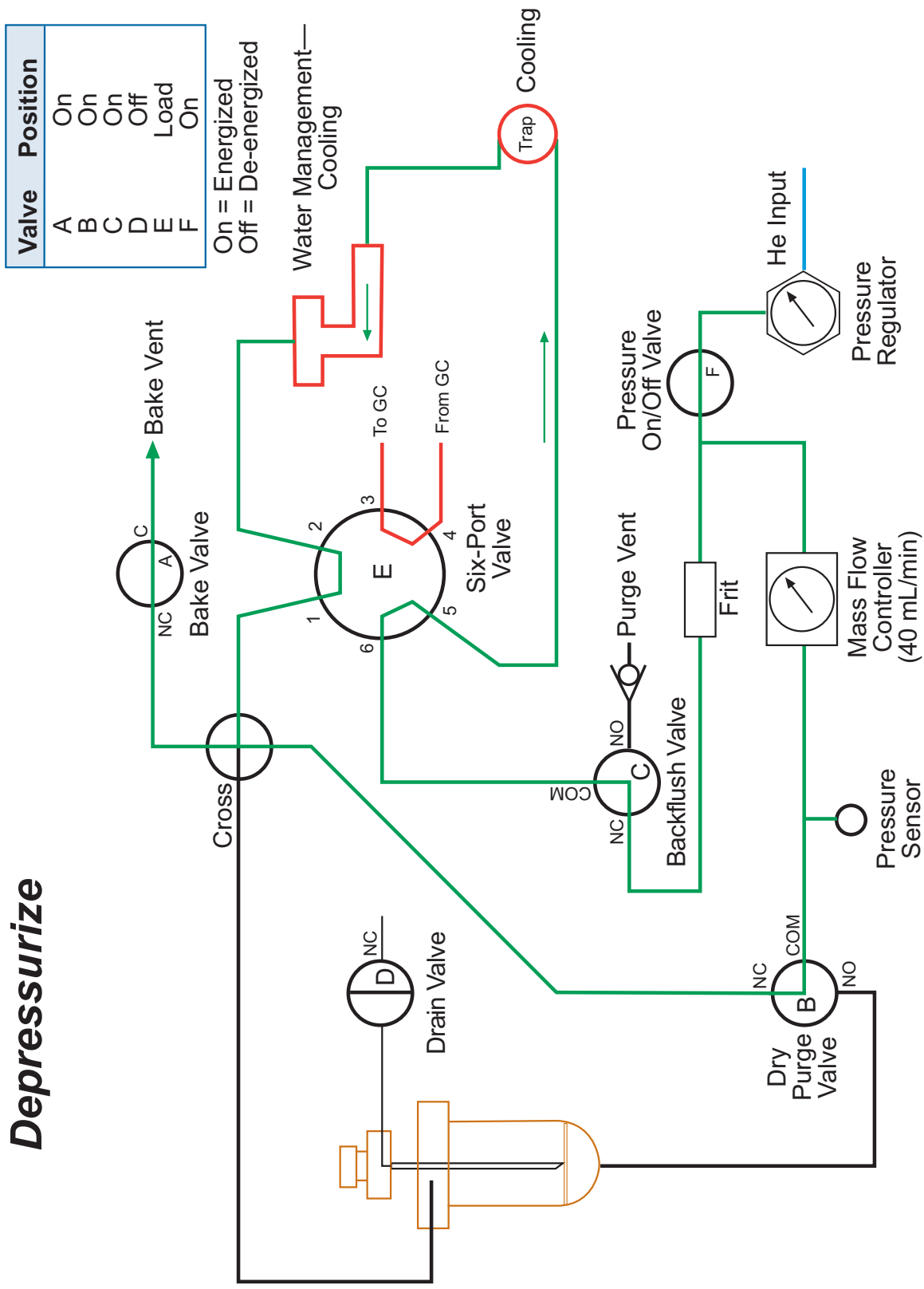

Figure 18.14. Depressurize

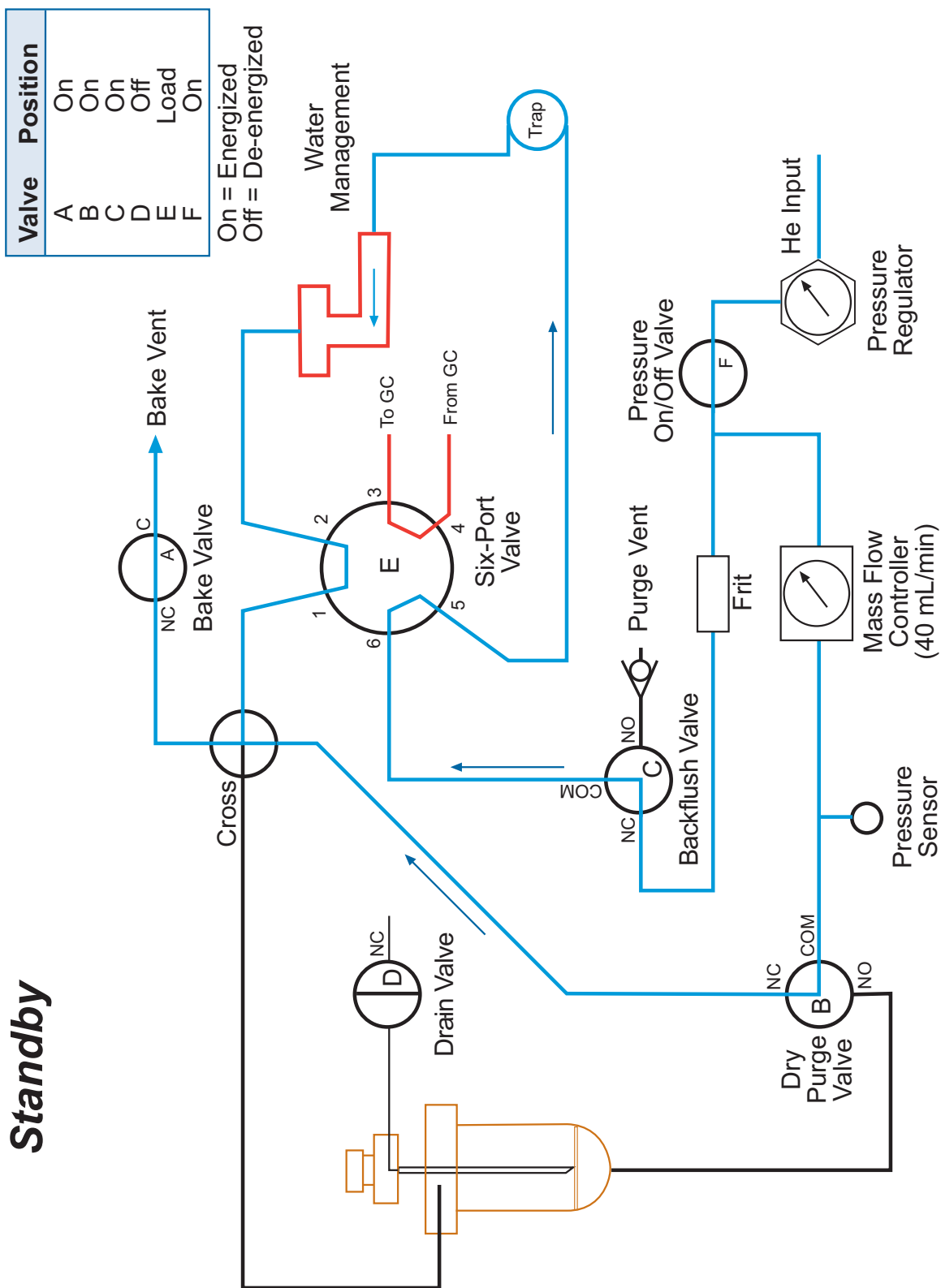
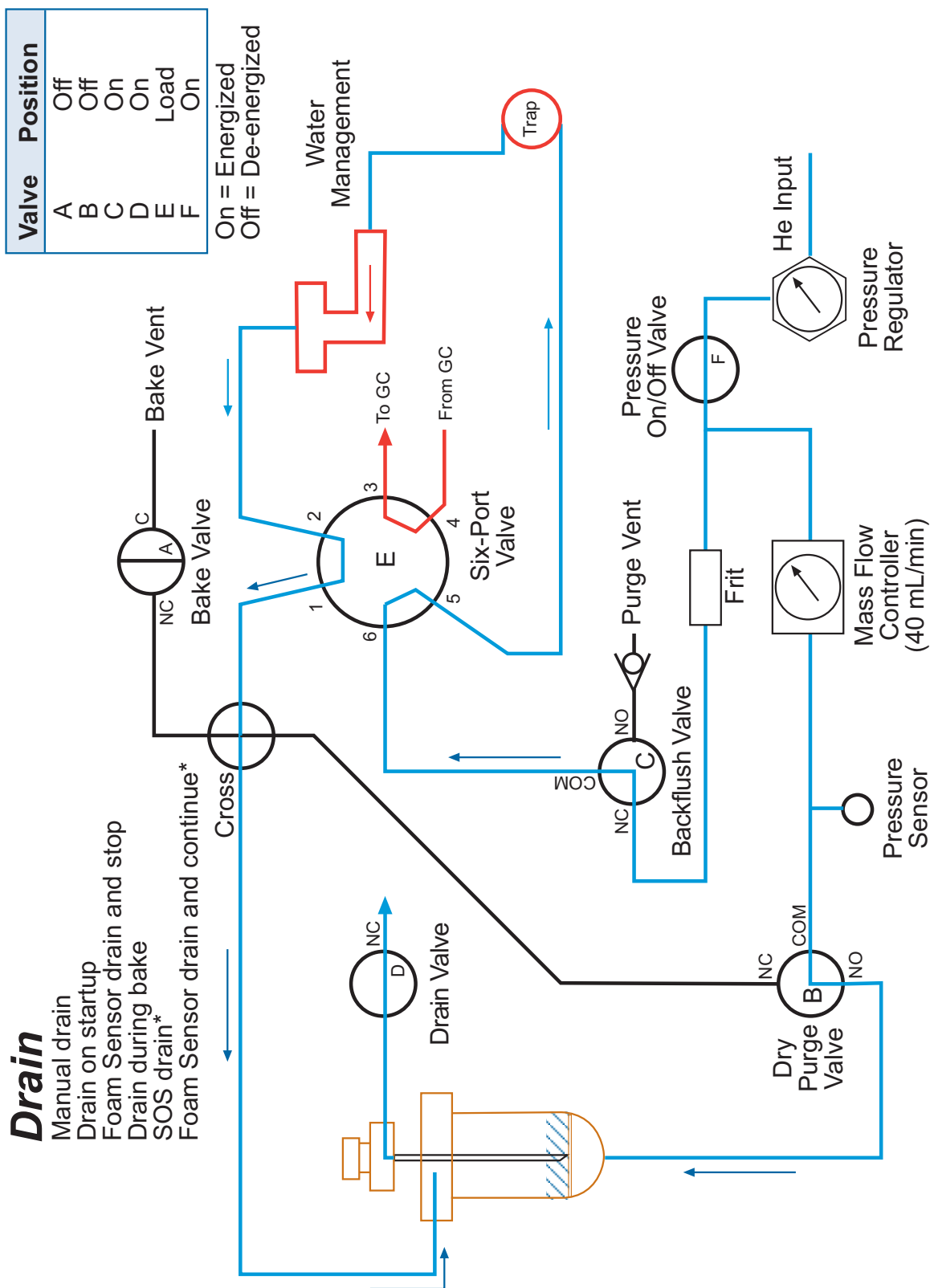

Figure 18.15. Standby



*Trap and water management at purge setpoint during these states.

Figure 18.16. Drain

Leak Test A (Dry System)

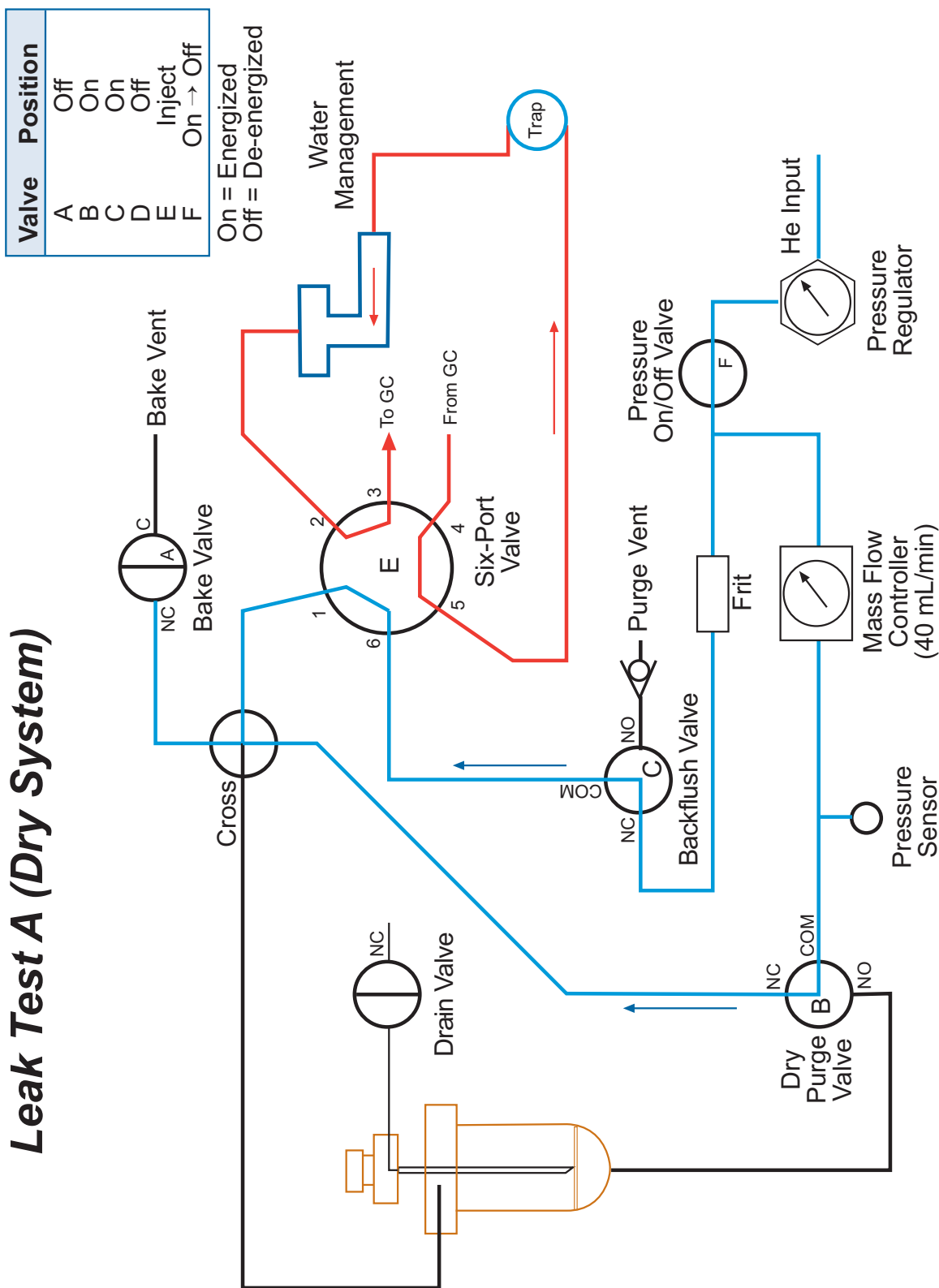

Figure 18.17. Leak test A (dry system)

Leak Test B (Dry System)

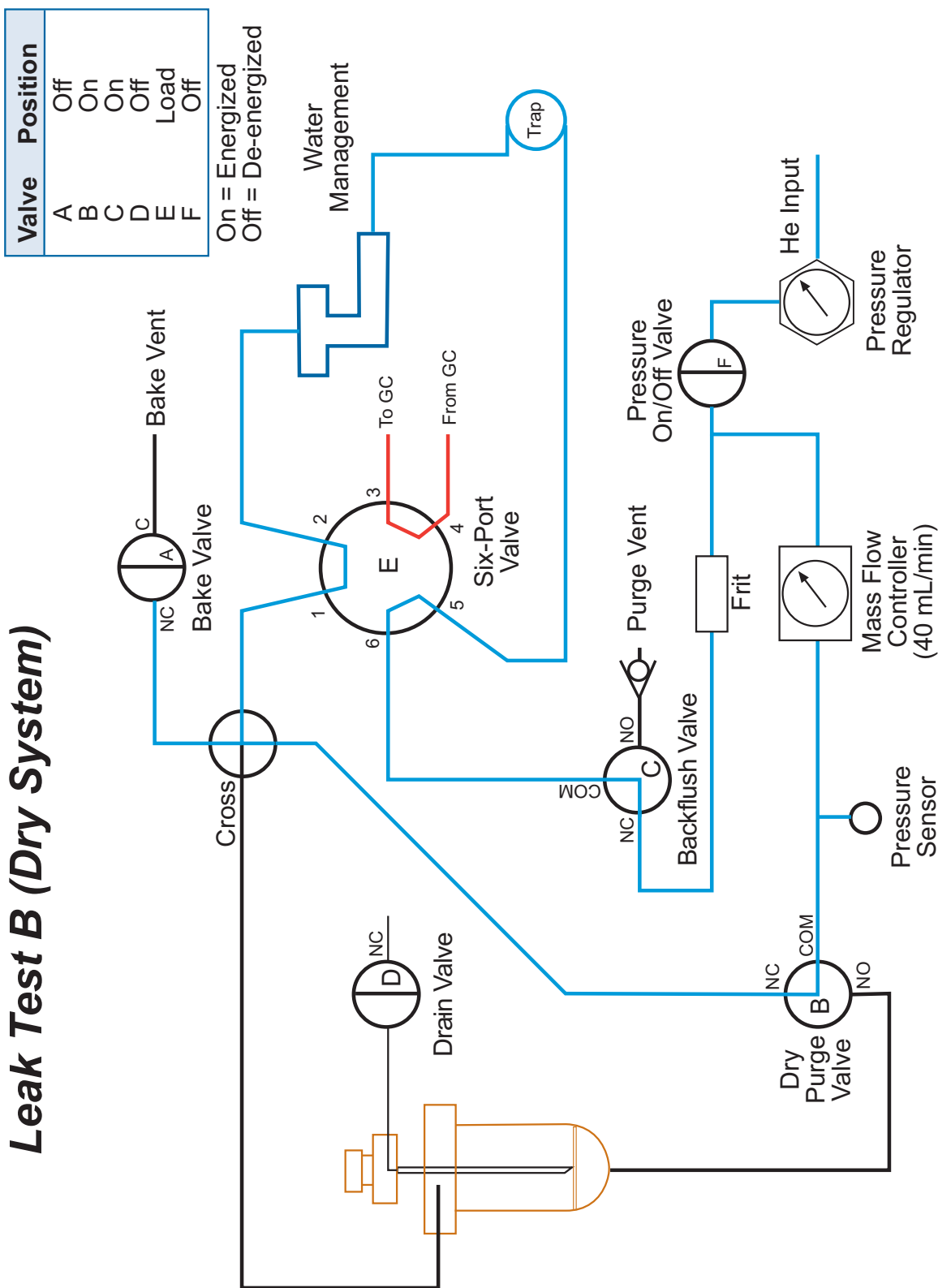

Figure 18.18. Leak test B (dry system)

Leak Test A (Wet System)

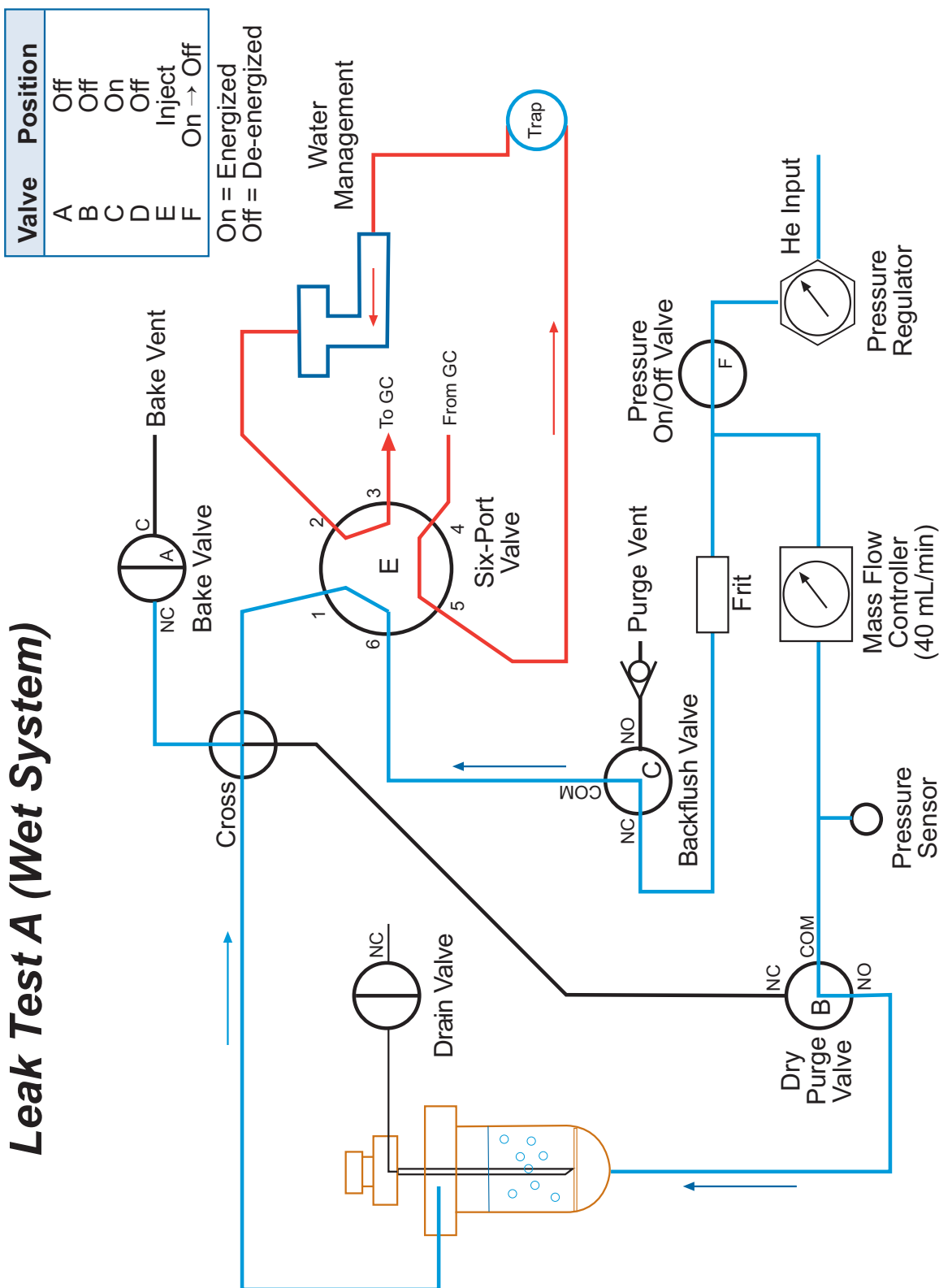
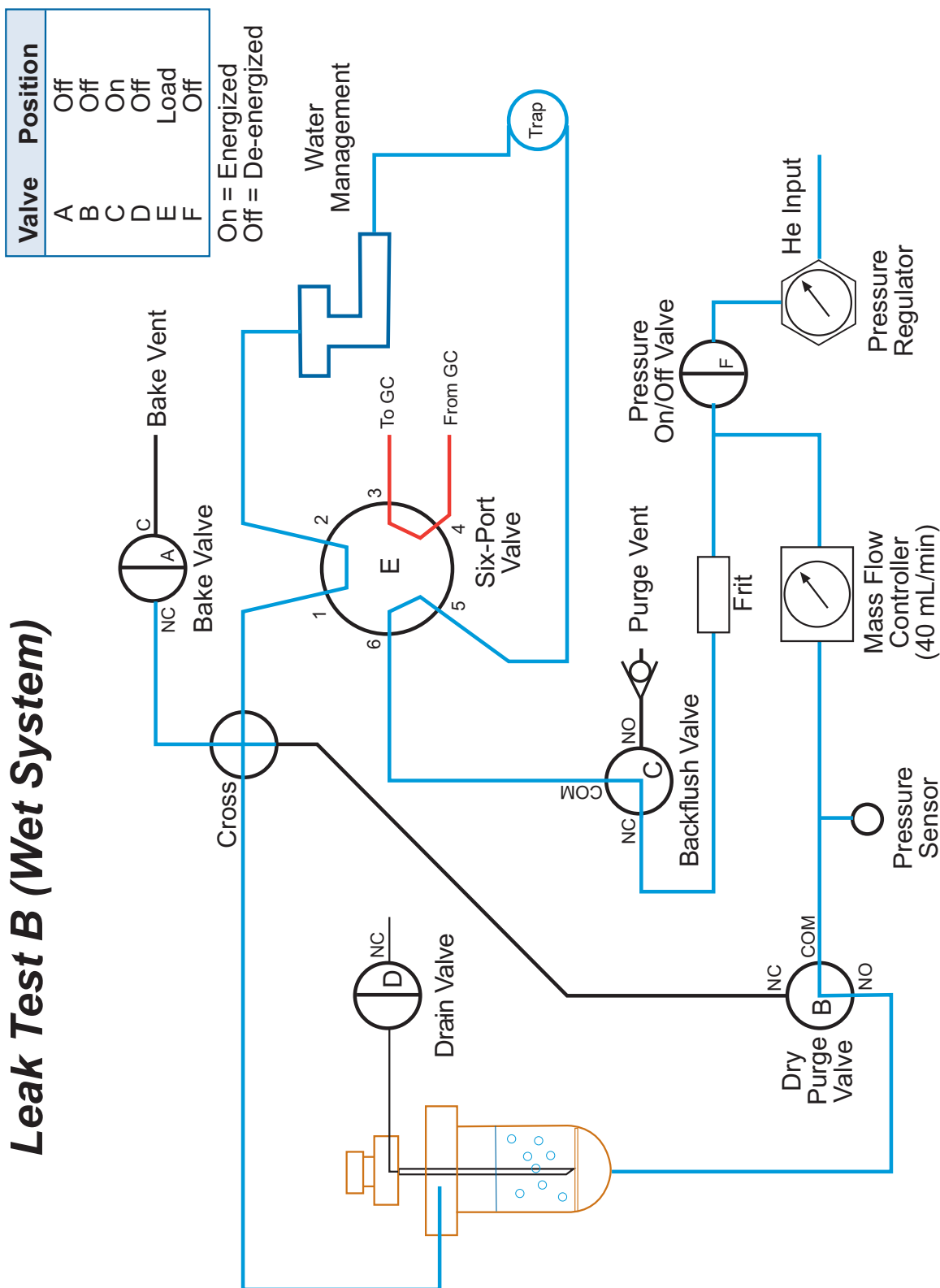

Figure 18.19. Leak test A (wet system)

Leak Test B (Wet System)



Valve	Position
A	Off
B	Off
C	On
D	Off
E	Load
F	Off

On = Energized
Off = De-energized

Figure 18.20. Leak test B (wet system)

Index

Numerics

03-504099-00 240

111427 37

112433 37

116038 23

128082 37

128108 37

147901 139

169640 37

187161 38

199521 240

217778 166

219972 235, 242

222836 177

226530 21

227348 235, 242

227363 235, 242

228114 235, 242

228122 235, 242

232801 240

258830 235, 243

258848 235, 243

276378 240

283549 243

287649 243

291435 243

291443 243

291625 39

296053 240

296087 240

307421 240

319822 21

321045 35, 36

321171 177

321457 173

321469 166, 167

321475 166

321487 139

321488 178

321495 168

321588 168

321589 177

321615 35

321651 36

321661 35, 36

321678 166, 167

322232 166

322237 166

A

Active sequence 90

Air inlets 137

Air-Tube

Autosampling 98

Configuration 88

Desorption 14

Enable 74

Power 11

Preheat 84

Prepurge 84

Prepurge Setting 203

Specifications 3

TC 11

Assemblies 230

Assembly Diagrams 250

pHDetect 156

Sparge Overfill Sensor (SOS) 183

Autosampling 98

B

Backflush bake 85

Bake gas vent 13

Bakeout 106

BNC socket 137

BTEX 235, 243

Buffer A inlet 137
Buffer B inlet 137

C

Cable 20, 231
Carbon molecular sieve 235, 242
Carbopack 235, 243
Carbosieve 243
Carboxen 243
Carrier gas inlet 11
Carrier gas source 19
Charcoal 235, 242
COM 2 port 11
COM 3 port 11
Communication cabling 20
Components
 Back panel 11
 Electronics module interior 18
 Front exterior 9
 Pneumatics module 13
Configuration
 Eclipse 87
 pHDetect 141
Connection
 Model 4552 Autosampler to Eclipse 39
 Transfer line to column 39
 Transfer line to GC 38
 Transfer line to low-dead-volume injector 39
 Transfer line to split/splitless injector 38
Counter settings 107
Current state bar 46, 47
Current status indicator 46
Cycle state indicator 46, 47, 86

D

Desorb 85
 Preheat 85
 Ready 85

Diagnostic tools 187
Dialog boxes
 Add New User 26
 Diagnostics 116, 174, 180
 Eclipse 4660 Login 24
 Eclipse 4660 Security Login 24
 Enter Priority Sample 92
 Import Data 114
 Instrument Log
 Add Entry 113
 Log Maintenance 115, 143
 Maintenance
 4551 Sampler 111
 Bakeout 106
 Change State 41, 104
 Counter Settings 107
 Fan Settings 109
 Heater Settings 111
 Instrument Log 112
 Leak Tests 42, 102
 pH Settings 105
 Purge/Bake 107
 Rotate 6-Port Valve 105
 Trap Condition 106, 125
 Valve Settings 110
 Modify 4660 P&T Connection 209, 213, 216, 221
 Modify User 27
 Network Settings 210, 215, 218, 222
 OIC P&T 4660 Security 24
 Operator Log
 Add Entry 114
 Permissions for User 26
Drain line 10, 13
Drain valve 13
Dry purge 85

E

Eclipse software
 Enabling the pHDetect 141
Eclipse user interface 44
Electrical connections 23
Electronics access cover 9
Emergency drain 137
Enabling pH measurement 142
Error bar 51

Error messages
Eclipse software installation 33
External cable 231

F

Fan 109
Features 1
Ferrules 231
Filter tube assembly 165
Fitting Adapter Septum 185
Fittings 231
Flow Diagrams 263
pHDetect 158
Foam Buster 164
Heater Assembly Installation 167
Heater Thermocouple Assembly Installation 167
Installation 169
Installing 164, 184
Replacement Parts 172, 237
Set screw 166
Sparge mount 166
Sparge Mount Installation 166
Foam Sensor 173
Installation 173
Knurled nut 175
Foam Sensor cable 173
Four-port cross 165
Frit sparger
Swage inlet 235, 247
Front cover 9
Fuse holder 12
Fuses 18, 233

G

Gas hookup lines 19
GC interface kit 19
Glass Reservoir
Cleaning 148

Glassware 2
Selection guide 240

H

Heat shield 177
Heater 233
Heater Assembly
Installation 167
Heater block 165

I

I/O board 15
I²C port 12, 138
Icon 44, 46, 49
Abort 45
Config 44
Drain 49
Editor 44
Exit 45
Lock 45
Main 45
Monitor 44
Pause 49
Priority sample 49
Progress 49
Start 49
Temperature 49
Infra-Sparge
Replacement Parts 238
Installation
Eclipse PC software 28
Foam Buster 164, 169, 184
Heater/Thermocouple 167
Sparge Mount 166
Foam Sensor 173
Needle sparger 35
pHDetect 139
Sample needle 168
Sparge Overfill Sensor (SOS) 177
Sparge vessel 35

Instrument log 112
Instrument states 83
Interior maintenance 126
Internal sample thermocouple 14

L

LAN connection port 12
Leak test 42, 102
Logging in 87
Low-dead-volume injector 39

M

Main board 18
Main menu 44
Maintenance 101
 Exterior 123
 Interior 126
 pHDetect 147
 Purge/drain needle 125
 Sample Pathway 127
 Sparge vessel 125
 Trap 123
Manual injection 96
Manual inlet 137
Metal clip 165
Method Editor 94
Methods 93
Model 4551A Autosampler 111
Model 4552 Autosampler
 Configuring 144
Modifying network settings 215, 218, 222
Module 234
Mud-Dawg 36, 37

N

Needle sparge line 14
Needle sparger
 Installation 35
Needle sparging 96
 Liquid samples 97
 Solid or sludge samples 97
Not at Setpoint warning 52
Not Ready LED 10

O

Offset sample needle 166
On-Trap Injector Option 184–185
Operating principles 1
Operational overview 86

P

P&T cycle time status 47
Part number lookup table 241
Password 24
pH buffer bottle 137, 140
pH Data
 Collection and Reporting 149
pH Probe 137
 Cleaning 148
 Storing 147
pH Reports
 Exporting 152
 Importing 149
 Print 150
 View 150
pH standard manifold 137
pHDetect 134–163
 Automatically Calibrate 147
 Back Panel 138
 Calibrating 145
 Cleaning the Glass Reservoir 148

- Cleaning the pH Probe 148
- Configuring 141
- Configuring the Model 4552 Autosampler 144
- Front Components 137
- Installation 139
- Maintenance 147
- Operation 144
- pH Settings 145
- Replacement Parts 154, 238
- Specifications 135
- Storing the pH Probe 147
- Unpacking and Positioning the Model 4560 138
- Pneumatics access cover 10
- Popups
 - Maintenance:Information 108
 - Progress Bar 50
 - Temperature Graph 50
- Positioning the Model 4560 19
- Power cable 23
- Power filter 18
- Power LED 10, 138
- Power receptacle 11, 12
- Power source 19
- Power supply 18
- Power switch 12
- Precautions 7
- Pre-heat 84
- Pre-purge 84
- Pressure indicator 46
- Priority sample 92
- Purge 84
- Purge end 85
- Purge flow controller 187
- Purge flow controller knob 14
- Purge gas
 - Indicator 48
 - Inlet 12
 - Inlet tube 13
 - on/off valve 15
 - Source 19
 - Vent 14
- Purge ready 84
- Purge/drain needle 14
 - Maintenance 125

R

- Relay I/O A port 11, 12
- Relay I/O B port 11, 12
- Relay I/O status box 117
- Remote I/O communication cabling 20
- Removing the standard sparge mount 164
- Replacement Parts
 - Eclipse Sample Concentrator 230
 - Foam Buster 172, 237
 - Infra-Sparge 238
 - pHDetect 154, 238
 - Sparge Overfill Sensor (SOS) 182, 239
- Reports 119
 - Export 121
 - Importing 119
 - Print 120
 - View 120
- Required materials 19
- RS-485 port 12

S

- Safety information 6
- Safety switch status 118
- Sample filter adapter 165
- Sample in port 138
- Sample injection port 10
- Sample Needle
 - Installation 168
- Sample out port 138
- Sample Pathway
 - Rinsing 127
- Screens
 - Active Method 53
 - Active Sequence 56, 90
 - Advanced Configure 66
 - Autosampler Configure 70
 - Basic Configure 65
 - Configure 64
 - Customer Information 32
 - General configuration 63, 87, 142
 - Maintenance 40, 80, 101, 145

- Method Editor 58, 94, 142
- OICLaunchPad 34
- Options Configure 71, 142, 170, 181
- Reports 119
- Sequence Editor 61, 89
- Status 45
- System configuration 76
- Temperature 52
- Trap configuration 74
- Sensor status 118
- Septum 185
- Sequence status 47
- Setting the purge gas pressure and flow rate 40
- Shimadzu GC 39
- Side access panel 10
- Silica gel 235, 242
- Sparge filter tube 16
- Sparge Mount
 - Cover 10
 - Removing 164
- Sparge mount
 - side port 10
- Sparge Overflow Sensor (SOS) 177
 - Adjusting 178
 - Assembling 177
 - Assembly Diagrams 183
 - Cable 177, 178
 - Cable connector 177
 - Installing 180
 - Plugging in 177
 - Replacement Parts 182, 239
 - Replacement parts 182, 239
 - Target 177
- Sparge vessel 14, 235
 - Installation 35
 - Maintenance 125
- Specifications 2
 - Communication interface 4
 - Communications 4
 - Computer requirements 5
 - Dimensions 2
 - Electronic control 3
 - Fuse requirements 5
 - Gas requirements 4
 - Input signals 4
 - Major options 6

- Optional glassware 2
- Output signals 4
- Performance 3
- pHDetect 135
- Power requirements 4
- Programmable temperature ranges 3
- Requirements 4
- Sample pathway 2
- Standard glassware 2
- Trap 3
- Valve 2
- Water management 3
- Weight 2
- Split/spliless injector 38
- Standby 84
- Startup procedure 24
- State sequencing 84
- State time status 47
- Status bar 51
- Status mask 118
- Syringe 96
- Syringe sample injection 96
- System pressure regulator knob 14

T

- Temperature probe socket 138
- Tenax 235, 242
- Thermocouple 233
- Thermocouple Assembly
 - Installation 167
- Three-way (or four-way) injection valve 9
- Touchscreen 10
- Trace 2000 GC 21
- Transfer line outlet port 12
- Trap 17, 235
 - #0, blank (no sorbent) 235, 242
 - #10, Tenax/silica gel/carbon molecular sieve 235, 242
 - #11, VOCARB 3000 235, 243
 - #12, BTEX (Carbopack B/Carbopack C) 235, 243
 - #7, Tenax only 235, 242
 - #8, Tenax/silica gel 235, 242
 - #9, Tenax/silica gel/charcoal 235, 242

Access cover 15
Changing 43
Conditioning 106
Fan 18
Indicator 48
Maintenance 123
Power line 17
Safety shutoff switch 17
Thermocouple connection 17
Transformer 18
Troubleshooting 187
Tube assembly 236
Tubing 236

U

Unpacking the Eclipse 19
User ID 24
Using sequences 89

V

Valve 236
Valve actuator assembly 15
Valve manifold assembly 15
Vent slots 10
VOCARB 3000 235, 243
Volatile Organic Compounds 134

W

Warnings
 Not at Setpoint 52
 Zone Not Heating 52
Water management fan 15
Water management fitting 16, 17
WinCE board 18

Z

Zone Not Heating warning 52